

ENERGY REGULATORY AUTHORITY

ANNUAL REPORT

**The Situation of the Power Sector and
ERE Activity during 2022**

Tirana, 2023

Table of Contents

THE PROGRESS OF IMPLEMENTING ERE STRATEGIC OBJECTIVES FOR THE PERIOD 2022 AND AS FOLLOWS, ACCORDING TO THE ACTION PLAN FOR IMPLEMENTING ERE STRATEGIC OBJECTIVES FOR 2021- 2023 PERIOD AS WELL AS THE APPROVAL OF THE ACTION PLAN FOR THE ERE STRATEGIC OBJECTIVES FOR 2023 PERIOD	20
1.1 Situation of the Albanian Power Sector	20
1.2 ELECTRICITY PRODUCTION	23
1.2.1 Electricity production for 2022 period	24
1.2.2 T The main technical data of electricity production from the public production plants for 2022 ..	28
1.2.3 Vlora TPP Situation	35
1.2.4 Electricity production from private, independent generation plants and those with priority	35
1.2.5 Generation from the plants that entered into generation during 2022.....	37
1.2.6 Electricity generation according to the network where are connected the generation plants	37
1.3 ELECTRICITY TRANSMISSION	41
1.3.1 Power balance	41
1.3.2 TSO activity	43
1.3.3 General situation of the Power System referring to TSO reporting	54
1.4 ELECTRICITY DISTRIBUTION	79
1.4.1 Electricity Distribution System Operator Activity (DSO company)	79
1.4.2 Electricity consumption	81
1.4.3 Electricity consumption structure	85
1.4.4 Electricity consumption profile	87
1.4.5 Indicators of the electricity supplied, sold or lost for each area and agency of the Distribution System Operator (DSO company) for 2022	89
1.4.6 Electricity sale effectiveness.....	94
2. ELECTRICITY MARKET	101
2.1 Electricity Market Monitoring Activities	102
2.1.1 Electricity Market Monitoring	102
2.1.2 Specific monitorings from the periodic information of TSO company	104
2.1.3 Other monitorings regarding the licensee’s activity in power sector	108
2.1.4 Transactions performed by KESH company, in the open (irregulate) Market during 2022	109
2.1.5 Recommendations for the operators and market participants from the nominations	115

2.2 Regulation on the integrity and transparency of electricity wholesale market (REMIT)	115
2.2.1 Obligations arising from the Regulation for the Integrity and Transparency of Wholesale Electricity Market (REMIT)	115
2.2.2 Monitoring and registration of the participants in the market implementing REMIT Regulation	116
2.2.3 Registration of market participants according to REMIT	116
3. ALBANIAN POWER EXCHANGE (ALPEX)	117
3.1 Steps undertaken regarding the commencement of Albanian Power Exchange ALPEX and its operational rules	118
4. LICENSING, ISSUE OF AUTHORIZATIONS AND SURVEILLANCE OF ELECTRICITY MARKET ACTIVITIES	121
4.1 Licenses and requests handled by ERE during 2022	121
4.2 Licensing in electricity production activity	121
4.3 Licensing in electricity trading activity	124
4.4 Licensed entities in electricity supply activity	126
4.5 Licensing of Albanian Power Exchange ALPEX company	127
4.6 Licensing in Natural Gas activities	127
4.7 Qualification for certificate plant/issue of the Guarantee of Origin for 2022 period	127
4.8 Issue of authorisations from ERE for 2022 period	128
4.9 Surveillance of the licensees during 2022 period	128
4.10 Annual Compliance Report for the Transmission System Operator of Electricity TSO company	129
4.11 Annual Compliance Report of the Electricity Distribution System Operator, DSO company	130
4.11 Compliance program of the Transmission System Operator of Natural Gas ALBGAZ company	130
4.12 Annual Compliance Report of Natural Gas Transmission System etimit të Gazit Natyror ALBGAZ company	130
5. ERE ACTIVITY IN TARIFFS AND PRICES REGULATION ACTIVITY OF ELECTRICITY AND NATURAL GAS	131
5.1 Review of the applications for tariffs and prices approval of the licensees in power and natural gas sectors for 2022 period	133
5.1.1 Application of TSO company for the approval of electricity transmission service for 2022 and for 2022-2024 period	133
5.1.2 Application of the Electricity Distribution System Operator for defining the tariffs for the electricity distribution service	134

5.1.3 Review and approval of electricity retail prices for the end use customers that are served from the Universal Service Supplier	135
5.1.4 Costs that are included in calculating the electricity retail price for the household customers with consumption over 800 kwh per month	136
5.1.5 Defining the electricity sale prices from the Supplier of Last Resort for 2022 period	137
5.1.6 Approving the temporary transmission tariff for natural gas from Albgaz company for 2023... 142	
5.2 Defining the electricity purchase price produced from small renewable resources from solar, wind and the biodegradable part of solid wastes that utilize the industrial, urban and rural wastes for 2021 and 2022 period	142
5.2.1 Defining the electricity purchase price generated from small renewable resources from solar, wind and the biodegradable part of the solid wastes that utilize the industrial, urban and rural wastes for 2021 period	142
5.2.2 Defining the electricity price generated from the plant of handling the urban wastes in Elbasan for “Albtek Energy” company	143
5.2.3 Defining the electricity purchase price generated from solar small renewable resources with installed capacity up 2MW for 2022 period.....	144
5.2.4 Electricity purchase price from the existing priority producers for 2022 period.....	144
5.3 Electricity purchase costs implementing the conditions for setting public service obligation from the licensees in power sector for 2021 period	146
5.3.1 Electricity purchase costs from the “Universal Service Supplier” company	146
5.3.2 Electricity purchase costs from the “Distribution System Operator” company to cover the losses on the distribution network for 2022.....	148
5.4 Electricity Prices in Regional Countries for 2022 period	152
6. NATURAL GAS SECTOR REGULATION	154
6.1 Situation in our country	159
6.2 Trans Adriatic Pipeline (TAP) – Greece, Albania, Italy	160
6.3 TAP a strategic project for Albania and South-east	160
6.3 TAP active contribution in Europe’s market integration and security of supply	161
6.4 TAP – Short summary of significant developments for 2022	162
6.5 TAP expansion capacity	165
6.6 Connections requests received for TAP in Albania	166
6.7 Operations Forum of Gas South Corridor and Energy Transition	168
6.8 Carbon Management Plan for 2022-2025 period.....	168
6.9 By – legal acts approved by ERE during to perform Natural Gas Sector activity	169
6.10 ALBGAZ company during 2022	181
6.11 Future objectives in Natural Gas Sector	185
6.12 Relations with International Institutions in Natural Gas Sector	187

7. REGARDING ERE REPORT FOR IMPLEMENTING AND FOLLOWING OF THE RECOMMENDATIONS OF “PARLIAMENT RESOLUTION FOR THE ASSESSMENT OF ERE ACTIVITY FOR 2021	188
8. ERE ACTIVITY IN THE DEVELOPMENT OF THE DEVELOPMENT OF THE SECONDARY LEGISLATION AND OTHER LEGAL AMENDMENTS HAPPENED DURING 2022	194
9. ERE ACTIVITY IN CUSTOMER PROTECTION AREA AND SUPERVISION OF THE STANDARDS	203
9.1.1 Complaints for electricity overinvoicing	205
9.1.2 Complaints for Economic Damage	205
9.1.3 Complaints for the referring values	206
9.1.4 Complaints for fictitious contracts	206
9.1.5 Complaints for new connections	207
9.1.6 Complaints for tariff amendment.....	207
9.1.7 Different complaints	207
9.2 Giving voice to the customer	210
9.3 Supervision of customer service for the suppliers in the free market	213
9.4 Customers /self-producers	214
9.5 Secondary legislation for the customer	216
9.6 Monitorings of the licensees in public services activities	224
10. ERE INTERNATIONAL ACTIVITIES	227
10.1 International Relations	227
10.2 Active Participation as a Member at International Organizations	228
10.3 ERE bilateral relations	229
11. ERE ORGANIZATION CHART AND THE ADMINISTRATION OF HUMAN RESOURCES	229
12. ADMINISTRATION OF ERE FINANCIAL RESOURCES DURING 2022.....	233
Annex 1. AUDIT REPORT OF THE FINANCIAL STATEMENTS	235
Annex 2. PERFORMANCE REPORT	248

Table of Figures

Figure 1 Power System Scheme (Source: ERE)	21
Figure 2 Power Flow and Commercial scheme (Source: ERE).....	22
Figure 3 The data on the producers for 2022 period.....	25
Figure 4 Net domestic production for 2022 period.....	26
Figure 5 Contributors of domestic production during 2022 (MWh).....	26
Figure 6 Monthly domestic production for 2022 compared to the average of the 2009-2022 period	27
Figure 7 Net domestic historic production for 2009-2022 period regarding the average production for this period	27
Figure 8 Structure of the Electricity Plants of Public Production (Source: KESH company)	28
Figure 9 Electricity Production from Drini Cascade HPP-s	30
Figure 10 Electricity production from Drini Cascade HPP-s during 2022	31
Figure 11 Water discharges from Drini Cascade HPP-s (2002-2022) period (Source: KESH company)	31
Figure 12 Level of Fierza lake during 2022 in (m).....	32
Figure 13 Level of Fierza HPP for 1991 – 2022 period.....	33
Figure 14 Level of Fierza lake in (m) regarding to minimum and maximum average of 1991 – 2022 period.....	33
Figure 15 Average monthly inflows (m ³ /sec.) in Fierza HPP during 2022 compared to the historical average	34
Figure 16 Daily Energy Reserve in Drini Cascade during 2022.....	35
Figure 17 The data on priority and independent producers for 2022.....	36
Figure 18 The data on independent producers for 2022	36
Figure 19 The data on priority producers for 2022.....	36
Figure 20 Photovoltaic plants and waste management for 2022.....	37
Figure 21 Production from the Plants introduced to production during 2022	37
Figure 22 Production from the plants connected to the transmission system during 2022.....	38
Figure 23 Production from the plants connected in the distribution network during 2022 period	41
Figure 24 TSO Power Balance for 2022 compared to that of 2015 - 2022 period (MWh).....	41
Figure 25 Schematic submission of the electricity flows of the Albanian Power System for 2022	42
Figure 26 The lines according to the voltage level of the Transmission System	44
Figure 27 Structure of the Albanian Transmission System	45
Figure 28 Scheme of the Albanian Transmission System	46
Figure 29 Single stage scheme of the Albanian Power System in 400/220/150/110kV level.....	47

Figure 30 Substations of the transmission system	48
Figure 31 Main assets of the transmission system	49
Figure 32 The approved “Ten-year development plan” of the transmission network 2015 – 2025 period.....	51
Figure 33 The investments realized from TSO company with its own funds for 2022	53
Figure 34 Realized investments from the TSO company with the international funds	54
Figure 35 Provided balance of the request and electricity supply in the internal market for 2023 – 2027 period	61
Figure 36 Long-term foresee of the request for electricity for the 2023 – 2040 period	62
Figure 37 Foreseen schenarios of electricity requirement	62
Figure 38 Maximum and minimum values of import-export in transmission capacities	66
Figure 39 NTC expected models of production, the cross-border exchanges and consumption	67
Figure 40 Breakdowns in the transmission system	73
Figure 41 The data on the transmission line disconnections during 2022	74
Figure 42 Main indicators of DSO company, FSHU company and FTL company during 2022 period	81
Figure 43 Total electricity consumption in the country throughout the years	82
Figure 44 Contributions of net domestic production and import-export balance in total consumption of electricity in Albania	
Figure 45 Components to cover the consumption and electricity consumption components ensured for 2021 – 2022 period	84
Figure 46 Distribution of DSO customers according to the regions and the categories during 2022.....	85
Figure 47 Distribution of the customers number for 2022 according to the categories (%).....	86
Figure 48 Invoicing reports according to customer categories during 2022 (Source: FSHU company).....	86
Figure 49 House-hold customers to total consumption of the country throughout the years	87
Figure 50 Average daily consumption for each month of 2022.....	88
Figure 51 Average daily profile on hourly basis of the load for 2022	88
Figure 52 The profile and the peak load during December 2022 (MW).....	89
Figure 53 The profile and minimum load during March 2022 (MW)	89
Figure 54 The data about the main indicators for any agency of DSO company during 2022 period.....	90
Figure 55 Distribution of electricity supply according to regional directories (%)	91
Figure 56 Distribution of electricity losses according to regional directories (%)	91
Figure 57 Monthly/annual losses in the distribution system, compared to electricity losses target	92
Figure 58 The quantity for the supply and the electricity losses on the agencies and regions of the distribution network	93

Figure 59 Power Balance of 2022 according to TSO and DSO reporting	94
Figure 60 Annual losses in the distribution system for 2009-2022 period	95
Figure 61 Graph of annual losses for the Distribution system for 2009-2022 period.....	95
Figure 62 Annual losses in the distribution system for 2009-2022 period	96
Figure 63 Level of monthly collections for 2011-2022 period	96
Figure 64 Total annual collections 2011 – 2022	97
Figure 65 Progress of sales effectiveness indicators of Distribution System Operator in (%)	98
Figure 66 Sales effectiveness of FSHU company / OSHEE Group, 2009-2022 period	99
Figure 67 Total losses to the Electricity introduced in Power System to consumption.....	99
Figure 68 Invoice/collection 2009-2022, with VAT	100
Figure 69 Data on main assets of DSO company	101
Figure 70 Data for the Capacity Allocation Auctions in the Transmission System during 2022	105
Figura 71 Total imbalances for 2022 (MWh)	107
Figure 72 SEE indicators for 2022 according to the target and the fact	109
Figure 73 Transactions performed during 2022 from KESH company	111
Figure 74 Import – Export balance of electricity throughout the years	112
Figure 75 Market Participants during 2022	114
Figure 76 Register of Market Participants according to REMIT 2022	117
Figure 77 Licensed entities for the electricity production activity for 2022.....	124
Figure 78 Licensees in Electricity Trading activity during 2021.....	125
Figure 79 Licensed entities in electricity supply activity during 2022	126
Figure 80 Plants equipped with Guarantee of Origin certificate for 2022	127
Figure 81 Sale prices and the electricity average weighted price of the supply from the SoLR for 35 kV	138
Figure 82 Moving curve of the average weighted price of electricity purchase from FSHU company for the customers connected in 35 kV voltage level, which are supplied from SoLR, for 2021-2022 period (Source: ERE)	138
Figure 83 Electricity purchase price from FSHU company to cover the need of SoLR customers connected in 35kV voltage level for 2021 – 2022 (Source ERE).....	139
Figure 84 Moving curve of electricity sale prices from the Supplier of Last Resort for the customers connected in 35 kV voltage level, approved from ERE for 2021-2022 period.....	139
Figure 85 Realization of SoLR indicators for 2021 – 2022 period.....	140
Figure 86 Electricity sale prices for the customers connected in 20/10/6 kV voltage levels, supplied from the Supplier of Last Resort for 2022.....	141

Figure 87 Realization of Supplier of Last Resort indicators for 2022, for the customers connected in 20/10/6 kV voltage levels	141
Figure 88 Production progress throughout the years from Priority Producers and ASHTA4 HPP	145
Figure 89 Revenues from priority generators	146
Figure 90 Sold electricity quantity and the revenues from the electricity sale of FSHU company	147
Figure 91 Structure of the quantity purchased to cover the losses in distribution system for 2022-2021	148
Figure 92 Structure of the expanses for electricity purchase to cover the losses in the distribution network for 2022 – 2021 period.....	149
Figure 93 Tariffs and Prices of Electricity approved throughout years for 2012 – 2022 period.....	151
Figure 94 Average price of electricity sale from FSHU company for 2012 – 2022 period.	152
Figure 95 Average price realised for the sale of electricity for different categories of end use customers ..	152
Figure 96 Electricity prices for non-household customers in regional countries for 2021 period.....	153
Figure 97 Electricity prices of household customers in the region countries for 2022.....	153
Figure 98 Greatest generators in the world for natural gas	155
Figure 99 Graph of setting the renewable resouces from Wind and Sun in Europe	156
Figure 100 Production of fossil sources in the world	157
Figure 101 The tipping point for fossil energy	158
Figure 102 World perspective for the mix request for electricity for 2030	159
Figure 103 Expansion of TAP project capacity	166
Figure 104 Registered and settled complaints	209
Figure 105 The complaints received according to the communication channels	210
Figure 106 Metering Indicators for the Quality of Supply and Security Performance to the Transmission Network	222
Figure 107 Organizational Chart of Energy Regulatory Authority	230

Introduction

Overview of the Power Sector in our Country for 2022

Energy Regulator Authority (ERE) is the regulatory authority of Power and Natural Gas Sectors in Albania, which operates pursuant to Law no. 43/2015 “On Power Sector”, as amended, Law no. 102/2015 “On Natural Gas Sector”, as amended, Law no. 7/2017 Law no. 7/2017 “On the promotion for the Use of Energy from Renewable Sources” as well as other approved legal acts implementing them.

ERE in exercising its activity aims to guarantee the compliance of market participants obligations for electricity production, trading and supply to ensure a qualitative and lowest cost of electricity supply for the customers. ERE implementing the effective legal acts and taking into consideration the customers rights and interests, the security and quality of electricity supply service and the requirements for environmental protection, performs the licensing of the entities in exercising the activity in the sector, monitors the electricity market, drafts the regulatory framework, reviews according to the respective methodologies the tariffs and prices applications.

ERE Board, is the decision-taking body for all issues under ERE jurisdiction and competence. ERE Board is composed of the Chairman and 4 Board Members, which are appointed by the Parliament for a 5-year period.

According to the requirements of “Power Sector” Law, as amended and “Natural Gas Sector” Law, as amended, it is drafted this report on the “Situation of the Power Sector and ERE Activity during 2022” for the Republic of Albania Parliament.

This report submits a detailed description as well as the data on the progress of Power and Natural Gas Sectors for 2022, reflecting in a comparison way the indicators of this year with the previous year.

Total production capacity of electricity installed in our country until 31 December 2022 is **2,614 MW**, which is increased in 2022 compared to 2021 with about **9 MW**.

Regarding electricity production, as evidenced as follows on the Report, it results that for 2022, the Total Net Domestic Production of electricity realized is **7002645 MWh**, from which **3859730 MWh** is produced from the plants owned by the public KESH company and **3 142920 MWh** is produced from other plants. Electricity production realized for 2022, from KESH company is **55.11 %** of the total electricity production in our country and the electricity production from other producers is **44.89%**. Compared to 2021, the electricity production realized from KESH company covered **59.6%**, of total electricity production in our country and the electricity production from other producers covered about **40.4%**. As evidenced for 2022 there is a decrease of KESH company contribution in electricity production realized with about **4.5%** compared to 2021.

Based on the data reported from the licensees, 2022 is considered relatively good from the hydrological perspective in terms of energy production. This is due to the fact that the realized production for this year of **7,002 GWh**, is **861 GWh** higher than the average electricity production during the period from 2009 to 2022.

In recent years, in our country are installed the electricity production plants of photovoltaic power plants, which contribute to the diversification of electricity production sources, where their total installed capacity is **23 MW** and total production results to be **5092 MWh**.

The electricity consumption for 2022 reached **7,923,713 MWh**, as evidenced on this report, the lowest recorded electricity consumption in our country was in 2007, with **5,767,652 MWh**, while the highest electricity consumption was recorded in 2021, with **8,414,836 MWh**, which also represents the highest historical consumption in our country. Compared to 2021, there is a decrease in electricity consumption in the country for 2022 by **491,123 MWh**.

The decrease in total electricity consumption in the country for the year 2022, compared to 2021, is approximately 5.8%. At the same time, the total electricity consumption for 2022 is approximately 11.3% higher than the average consumption presented in the remainder of this report.

This decrease of total electricity consumption is reflected for all categories of consumers, but especially for consumers supplied in the irregulated market, that for 2021 consumed approximately 1,361 GWh of electricity, while in 2022 these consumers consumed around 929 GWh of electricity. The decrease in electricity consumption is also as result of the energy crisis caused by the war in Ukraine, which led to an increase of electricity prices. In this situation, the governments of different countries, including the government of the Republic of Albania, took measures to reduce electricity consumption through awareness campaigns.

The total electricity consumption in the country during 2022 is covered from electricity generation realized by KESH company, independent electricity producers, electricity priority producers, as well as electricity imports.

As will be mentioned further, the net domestic production for 2022, results 7,002 GWh, while the total consumption in the country is 7,924 GWh, resulting in a net balance to the imports of 921 GWh.

The net balance of electricity exchange for 2022, of about 921 GWh, is the difference of the realized export of 2,123 GWh and the import of 3,044 GWh. This difference is understandable due to the fact that the Albanian power system based its electricity production on hydro resources, where during rainfall periods exports electricity and during dry periods throughout the year, electricity is imported to meet the domestic demand. In other words, the production profile in our country does not always align with the consumption profile during the same periods. Therefore, diversifying the sources of electricity generation in the country will have a positive impact by reducing the amount of imported electricity.

As indicated in the report, the electricity losses in the distribution network during 2022 are 19.7%, with a slight increase of 0.1% compared to the target set in Council of Ministers Decision No. 758, dated 09.12.2021, "On an amendment to Council of Ministers Decision No.253, dated 24.04.2019, "On the approval of the financial consolidation plan of the public electric-energy sector." The overall losses in the distribution system for the year 2021 are 20.62%. Therefore, 2022 shows a lower level of losses compared to 2021.

The level of losses in the transmission system for 2022 is 199,994 MWh or 2.09% of the transmitted electricity. This level of electricity losses to the transmission system for 2022 represents a slight decrease compared to 2021, which was 2.13%.

The total level of collections for 2022 reported from the operators is 98 % to the invoiced electricity. This level of collections for 2022 results with a slight decrease, compared to the level of collections realized for 2021, of about 97.4 %.

The data of 2022 show the general number of customers 1,301,905. The structure of electricity customers even for 2022 is mainly concentrated to household customers, that compose 86.02 % of the total number of customers. To the demografic distribution of customers even for 2022 the majority part is in Tirana, with about 22.7 % of the customers.

The structure of customers is also reflected in the structure of electricity invoicing realized for 2022. Household customers occupy the majority part of the invoiced electricity for 2022, or 43.12% of the

invoicing realized for 2022.

Regarding ERE activity in setting the tariffs and prices for 2022 it results as follows: TSO company requires from ERE the approval of the average electricity transmission tariff for the 3-year period 2022 – 2024 in the 1.47 ALL /kWh value from the effective tariff of about 0.75 ALL /kWh.

ERE with Board Decision no. 72, dated 13.04.2022 set the transmission service tariffs of electricity for the 1 May 2022 – 31 December 2024 period, of about 0.85 ALL/kWh.

ERE after reviewing the application of DSO company, with ERE Board Decision no. 73, dated 13.04.2022, approved the distribution service tariff according to the voltage level, for 1 May – 31 December 2022 period, as follows: (i) The electricity distribution tariff for the customers connected to the 35 kV voltage level is 1.55 ALL/Kwh, (ii) the electricity distribution tariff for the customers connected to 0.6 voltage level is 20 kV - 3.99 ALL/Kwh, (iii) the electricity distribution tariff for the customers connected to the 0.4 kV voltage level is 6.42 ALL/Kwh, (iv) the applicable price for reactive electricity invoicing for the 1 May – 31 December 2022 period is about 1.92 ALL /kVArh.

The FSHU company does not apply for prices amendment at ERE for 2022. ERE performs its prior assessments, based on the data submitted for the realization of the 10-month period of 2021. At the end of the assessment, it resulted that the average electricity sale price of 10.7 ALL/kWh was assessed to recover all the costs of the universal service of supply activity by the end of 2022 period.

Based on the analysis of the periodic reports of 2022, it is evident that the amount of electricity sold to SoLR connected at the 35-kV voltage level was 22.9 GWh, with an invoiced value of 735 milion ALL, resulting in an average annual price of 32.11 ALL/kWh.

With the approval of the new tariffs of electricity distribution service with Board Decision no. 73, dated 13.04.2022, for the customers connected to the 20/10/6 kV voltage level was defined the sole tariff of 3.99 ALL/kWh. The effectiveness of this decision from 1 May 2022 was reflected even in the calculations of electricity sale price from the Supplier of Last Resort for the customers connected in 20/10/6 kV voltage.

On the conditions where each component remains unchanged with ERE Board Decision no. 229, dated 12.09.2022, it was decided the approval of the price of 18.26 ALL/kWh, for the 01.08.2022 – 31.12.2022 period.

Referring to the electricity balance it results that the electricity quantity consumed for the customers connected to the 20/10/6 kV voltage level for 2022 is 1,079 GWh, with an invoiced value of about 20,058 milion ALL.

At the same time, ERE with Board Decision no. 166, dated 28.06.2022 approved the electricity purchase price produced from the photovoltaic plants with installed capacity up to 2MW of about 97.21 Euro/MWh, for 2022. Also, ERE with Board Decision no. 253, dated 21.12.2021 approved the annual price of about 8.5652 ALL /kWh that shall be paid to existing priority producers for 2022.

Also, during 2022, with Board Decision no. 327, dated 14.02.2022, ERE approved the annual price that shall be paid to existing priority producers for 2023.

The Power Exchange is established with Council of Minister Decision no. 322, dated 15.05.2019, “On the establishment and defining the legal Form of the ownership structure of the shareholder capital of the Market Operator” and Council of Minister’s Decision no. 609 dated 11.09.2019 “On defining the criteria and procedures for the selection of the participants in the shareholder capital of the Market Operator” which was established on October 2020, during 2022 there were important developments.

ERE with Board Decision no. 272, dated 27.10.2022, decided to “Initiate the procedure of approving the electricity market rules (ALPEX rules, the definitions, trading procedures as well as the clearing

and settlement procedure). These rules were widely discussed with the interested parties and the Kosovo Regulatory Republic.

The Framework Agreement on electricity market coupling of Albania and Kosovo dated 21.10.2021, signed by Energy Regulatory Authority (ERE) and the Energy Regulatory Office of Kosovo (ZRRE), the Transmission System Operator of Albania and the Transmission System and Market Operator of Kosovo (KOSTT), provided that the Regulators shall coordinate on the same time to approve the terms, conditions or methodologies.

On these conditions based on Law no. 43/2015, “On Power Sector”, as amended, Council of Minister’s Decision no. 519, dated 13.07.2016 “On approving the electricity market model” with ERE Board Decision no. 347, dated 27.12.2022, decided to approve the electricity market rules the (ALPEX rules definitions, trading procedures as well as the the clearing and settlement procedures).

In natural gas sector, during 2022, ERE approved some by-legal acts which shall play a role in the expected developments of the transmission and distribution system, and there are approved the by-legal acts for the LNG terminal as well as other acts for the underground storage of natural gas, in Dumrea area.

ERE in cooperation with other public authorities for the development the regulatory framework may lead to the construction of 30 km pipeline from Vlora Terminal to the meeting point with TAP in Topoja (Fier). This may create the possibility of accelerating the repair of Vlora Power Plant (TPP) and setting it into operation. The 30 km pipeline from Vlora to Fier shall provide the opportunity to inject gas even at TAP network for the needs of the Region.

On the same time ERE cooperates with the Regulatory Authorities of Italy and Greece to improve TAP by-legal acts such are: TAP Network Code, the Market Test for 2022 that continues even for 2023, which shall bring an increase of natural gas transporting capacity from 10 miliard m³ of natural gas to a larger quantity.

For 2022, TAP transmitted about 12 bcm³ gas/year. This creates the opportunity that our country possess sufficient natural gas quantities through the points of Fier and Kuçovë.

As consequence, TAP transported about 8 billion m³ of gas at the Greek – Turkish border in Kipoi, where 6.8 billion m³ of gas are transported in Italy through Albania and 1.2 billion m³ of gas are supplied in Greece.

ERE also shall continue its work to identify the needs and requirements for natural gas as well as the study analysis on the users of natural gas in regional countries and the expectations for the Albanian market. For this study and the assessment of the provided scenarios, ERE shall be based on a strategic document “On approving the national energy strategy for 2018 - 2033”, approved with Council of Ministers Decision no. 480 dated 31.07.2018, and Council of Ministers Decision no. 87, dated 14.02.2018 “On approving the development plan of natural gas sector in Albania and the identification of priority projects”.

PROGRESS OF IMPLEMENTING ERE STRATEGIC OBJECTIVES FOR 2022 PERIOD AND IN CONTINUATION ACCORDING TO THE ACTION PLAN TO IMPLEMENT ERE STRATEGIC OBJECTIVES FOR 2021 – 2023 PERIOD AND THE APPROVAL OF THE ACTION PLAN FOR ERE STRATEGIC OBJECTIVES FOR 2023

With Bard Decision no. 74 dated 12.03.2021, ERE approved the Strategic Objectives for 2021 – 2023 and the next period, approved the Updated Calendar of Measures to implement these Strategic Objectives.

To implement these objectives ERE focus has been above all the process of the studies regarding;

(i) “The preliminary findings and study on electricity consumption in Albania and the customer behavior”. Aims to analyze consumers perceptions and behaviors regarding energy saving in relation to the use of household devices, primarily based on practice-oriented behaviors. By identifying the factors influencing energy consumption, the goal is to raise consumer awareness in order to understand:

- The use of electricity efficiently;
- The impact of information on selecting energy-efficient devices.

On this study are targeted to be submitted the typical factors that affect the customers behavior that use electricity in Albania.

(ii) The assessment of the legal and regulatory framework to use new technologies for the stations of charging the electricity vehicles, including the regulation of invoicing this service.

This study accesses the regulatory and legal framework in using new technologies for the charging stations of electricity vehicles including the regulation and tariff of this service, as well as the supporting schemes that exist in many European countries including subvention on vehicles purchase or even other tax advantages, the weight level of consumption in regional and our country.

(iii) Guideline on the services provided by Energy Regulatory Authority

The purpose of this Guideline is to provide a general review on the rules and procedures followed by ERE, setting the tariffs, the electricity market monitoring, draft of regulatory acts, customer protection as well as ERE commitment with the third parties and the national and international institutions.

With ERE Board Decision no. 20, dated 04.02.2022, it is handled the progress of implementing the strategic objectives for 2021, according to the measures plan for implementing the strategic procedures of ERE for 2021 – 2023 period and it is approved regarding the update of the measures plan for the strategic objectives of ERE for 2022 – 2023 period. On this document there are defined the strategic objectives that ERE aims to realize within the defined period to comply the legal obligations provided on Law no. 43/2015 “*On Power Sector*”, as amended and Law no. 102/2015 “*On Natural Gas Sector*”, as amended. The reviewed Calendar of Measures, resets on time some of the obligations and targes of the measures plans approved with ERE Board Decision no. 96/2021, to handle them within 2022-2023 period.

1. Realization of information session on the bids of electricity supply market (Price Comparison Tool)

Regarding consumer awareness and becoming a capable customer in assessing the bids, understanding the market mechanisms, to the opportunity in actively participating in electricity supply - related services, shall be clarified that the Energy Regulatory Entity (ERE) continues its work regarding the implementation of the platform and signing the relevant contract with the service provider. Currently, this contract is implemented, and it is expected to be operational within 2023. The platform shall provide the suppliers the opportunity to present electricity prices to consumers who select to be supplied from the liberalized market.

2. Preparation of the informative brochures for the customer

To achieve this objective, ERE has realized and published about 11 brochures, periodically publishing them on the ERE *website* and social media platforms to inform consumers regarding

various regulatory aspects that affect their interests as customers. Some of these published brochures cover the following topics:

- a. How to apply to benefit from electricity compensation;
- b. The meter control;
- c. The costs included on electricity invoice;
- d. Termination of the contract regarding the customer;

- e. What shall be included on the electricity invoice;
- f. When shall be disconnected electricity;
- g. When shall we complain at ERE;
- h. The procedure of switching the supplier;
- i. Electricity meter reading is performed by DSO company, for a 30 calendar days period.

For the following period, shall be continued the work to update the aforementioned information as well as to continue the collaboration with Energy Efficiency Agency to increase consumer awareness for the efficient use of electricity through QR codes integration on the electricity invoices, regarding ERE website URL.

3. Follow-up of the interest level in the country, on self - production of electricity

There are held correspondences with the majority of entities that trade and install photovoltaic panels requiring information regarding the interest level shown during March 2021- March 2022 period from the customers for installing the photovoltaic panels to reach an assessment regarding the rate of return of the investment performed for these plants.

ERE through official communications required information for about 10 trading entities regarding the interest level shown during March 2021- March 2022 period from the electricity customers for the installation of photovoltaic panels for the household and nonhousehold categories as well as an assessment from the trading entities regarding the rate of return of the investment performed for these plants.

Regarding these communications there are responded 2 entities, which informed that the handled plants are for non-household customers, mainly light industry, garment manufacturing, and heavy industry.

These entities also inform that there are 20 plants supplied with MAX capacity over 3.5 MWp and are contracted and are in implementation and supply process 5 MWp capacity.

During 2023 shall be continued the work to receive and process the data to draft an assessment on the interest level in the country of the self-producers and this shall be in conformity with the provisions of the new law for the Renewable Resources.

4. Public communication on the interest for technology

ERE through official communications required the information to the concessioners that trade electric vehicles on the interest level, the average costs, and the sales report during 2021 and as follows compared to the traditional ones, the facilitation or incentive practices regarding customer, tax obligations for this category.

The Working Group held by ERE to access the regulatory and legal framework to use the new technologies for the charging stations of electric vehicles, including the tariff regulation for this service, prepared a study for this issue which is published on ERE website. The findings of this study are published on ERE website, there are published short information on the social media and these are submitted to the stakeholders.

5. Training ERE staff on this new technology

Regarding this objective on May 2022 it is held the workshop “*Climate Obligations, Environmental Standards and Regulation*” where it was included a sub-topic about the electric vehicles (EV), their impact to the climate, pros&cons. On this workshop ERE representatives participated. On the same time ERE periodically shall continue to train the staff regarding these technologies for 2023.

6. Raising customer awareness on electricity rationalization

Regarding customer’s sensibilization on electricity rationalization, this objective is divided in two sessions:

- Deep information on the international legislation;
- Customer sensibilization on the efficient use of electricity.

ERE carried out some correspondences with the Energy Efficiency Agency and required them to coordinate the work for a quick and efficient handling of the issues on customer interest or informing them regarding our common purpose, the protection of customer's interest as well as efficient use of electricity. Currently ERE is officially negotiating with the Energy Efficiency Agency for preparing the information brochures which aim to submit the information to the customer to jointly handle this common issue of interest. ERE shall make all efforts that the prepared brochure shall have a wide distribution among the customers.

ERE together with the Energy Efficiency Agency required cooperation from the Universal Service Supplier (FSHU) company, regarding the generation of a link, QR Code that shall be integrated on the electricity invoice to handle the interest issues for the customer without additional costs. The generation of this link or the QR code shall comply the mission of both institutions to inform the customer not only about their rights but even the opportunity of using efficient energy by increasing its consumption. FSHU showed its will and agreed to increase cooperation in the framework of this initiative. ERE and the Energy Efficient Agency, during 2023 shall continue cooperation with FSHU company regarding the definition of application modalities regarding this cooperation.

Also, during 2022 there are performed continuous communications and are inserted to the online platform's impactful messages for the customers for their awareness in using electricity efficiently such as:

- j. How to reduce electricity consumption;
- k. Application call for household customers to use solar panels for heating purposes, up to 2000 (two thousand) household customers.

7. Giving voice to the customer

Regarding this session, it is separated on 3 items.

(i) Set into operation of the green number for the customer information

ERE signed a contract with one of telecommunication companies and currently the green number is active. This number serves as a free communication bridge for the customers with ERE. The customers regularly call to ask for the status of their complaint carried out at ERE. ERE specialists respond regarding the handle of the complaint and the customers are oriented to follow ERE official website at the complaint register that is updated regularly. ERE phone number set for the customer: **08002323**, as published on ERE official website, at the social networks and ERE official letters.

(ii) Organisation of trainings for the stakeholders to "Inform about the customer's rights"

During April 2022, the Albanian Consumer Center organized a series of presentations regarding the role of various institutions in consumer protection and the rights and obligations of consumers. In the meeting held on 07.05.2022, which mainly focused on consumer rights, ERE representatives submitted, among other things, as part of informing campaign, the informative brochures, as well as the option for access to information for the customers.

On June 14 and 15 June, was organized a joint meeting in Vienna between three important bodies of the Council of European Energy Regulators (CEER): Energy Community ECRB, MEDREG, the Mediterranean Energy Regulators. The two-day meeting was conceived as a *Workshop* among member regulators of these international organizations to discuss regulatory aspects in the European Union's Clean Energy Market model. The regulators, primarily represented by their top-level executives, as well as Consumer Protection representatives, discussed and exchanged opinions regarding the best practices to increase consumer engagement and participation in policymaking, as

an important actor in handling the interest issues and electricity market.

The Customer's Working Group (CUS WG) held a workshop in Milan on the Role of the Regulators for Customer Protection. The exchanges of information were enriched with the contributions of regional European counterparts, those of East Europe and the Black Sea such as: the Council of European Energy Regulators (CEER) with Christos Toliopoulos and the Energy Community, reviewing the national studies of the cases from the Algerian member CREG – the Spanish member Karima Sadou; CNMC (Comisión Nacional de los Mercados y la Competencia) – Egyptian member Odelin Calatrava; the Egyptian Gas Regulatory Authority; and the Albanian member ERE Albania – Energy Regulatory Authority for Albania.

(iii) Organization of collaborative meetings with customer offices in the country's municipalities as well as the organizations established for this purpose

ERE, continued the communication with the main Municipalities, such as that of Tirana and Elbasan. With the Tirana Municipality the meeting will be organized within 2023, while with Elbasan Municipality it is organized the meeting with the representatives of this institution as well as the respective structures for Settling Alternative Disputes between them. On these meetings it is presented the legal framework that regulates the power sector as well as ERE role in handling the customer's issues.

8. Protection of vulnerable Customers

Regarding the vulnerable customers, this objective for a detailed handling is divided in four sessions, regarding the issues as follows:

(i) Consultation with the respective Ministry and the concrete proposals for defining the criteria to receive the status with Council of Minister Decision

ERE by an official letter followed the communication with the Ministry of Social Welfare and Youth on the average number of families enrolled in the support scheme.

By FSHU company, and the Ministry of Social Welfare and Youth there is not a response regarding what is required by ERE or the progress of the working group held for this purpose from these institutions, to define the criteria to benefit from the vulnerable customers status.

(ii) Surveillance of FSHU company service, for the disconnection conditions of vulnerable customers

ERE by the respective official letter followed the communication with FSHU company, requiring information regarding the provision of FSHU service on the conditions of electricity disconnection conditions for the customers that use the necessary means for the lifecycle that operate with electricity, according to the conditions defined on the Regulation approved by ERE for this purpose.

ERE shall follow to take the measures through on-site monitoring at FSHU company focusing on the respect of the conditions defined on the regulation for the vulnerable customers status to whom the electricity shall not be disconnected.

(iii) Preparation of informative meetings with the representatives of customer protection association, regarding their rights and obligations

For this purpose, are organized various presentation trainings regarding the role of institutions for the amendment of customer protection and their rights and obligations. At the meeting realized on 07.05.2022 at the Customer Protection Center, ERE representatives above all presented as part of the informative campaign, the information brochures as well we the opportunity to access information for the customers.

(iv) Performance of a study regarding the best regulatory policies for customer protection in EU countries

Through a specific order, it is held the working group for preparing a study regarding the best regulatory policies for vulnerable customer protection according to the practices of the EU countries. The working group for this purpose, is processing the collected data and shall continue its work for the finalization of this study during 2023 which shall be informed to the interested parties.

9. Developmet of a Customer Portal

This objective is divided in two items:

(i) Establishment of the customer's portal

To comply this obligation, by ERE it is not realized a new website, but a specific item called Customer Services. This service includes the contracts that are related to the agreements between the customer and the Supplier, as well as the customer and the Distribution Operator, the form of the complaints where the customer with one click may submit the complaint at ERE without printing it and physically participating to the customer protection office; the information regarding the New connections and on this item are reflected the costs, conditions, procedures that shall be followed for the new connection; the customer's survey, set as a specific item for evaluating the satisfactory level of the customer connected to the service; How to find your supplier in the free market, an item by which are notified the end use customers, that fulfill the conditions for issuing to the liberalized market of electricity; Information to raise the awareness by which the customers are awared to show how to reduce electricity consumption; the register of the complaints by which the customers are oriented with the status of the complaint. These data are updated every week.

(ii) Periodic update of the customer complaint status of the customer handled by ERE for the track of the complaint on ERE website (with the unique access code)

The update of the complaint status is performed at the beginning of each week or on each case that came the responses or are handled the new complaints. The update of the complaint register according to the Transparency program is performed within 24 hours from the registration of new complaints or the receive of the response by the licensee to track the complaint in the shortest time possible from the Customers. On the *database* are inserted the updated data regarding ERE handling of the complaint, protocol no and the date of the official letter that the complaint is handled by ERE, the status of the licensee response regarding the complaint and the status of the request regarding its acceptance or refusal from the licensee supported on generated documented evidences, or even the acceptance status or the failute of the requurst, the cases where ERE issues the settlement or the recommendation for settlement of the licensee to whom it is exercised the complaint.

10. Defining the metering indicators and assessment the performance to the Customer service guaranteed to any licensee on the supply

Regarding the definition of metering indicators and the evaluation of the service performance to the Customer guaranteed to any licensee in the supply service, this objective is divided in 3 items:

(i) Update and supervision of quality of service standards

Regarding the update of Quality Standards for the distribution service they are the same as those Standards approved with ERE Board Decision no. 97, dated 07.04.2021 "On the standard criteria of the service of supply and security performance to electricity distribution network for 2021".

Regarding the update of Quality of service standards by TSO company for 2022 there are updated the Standards approved with ERE Board Decision no. 244, dated 02.12.2021 "On the indicators of the standard criteria indicators for electricity transmission service for 2022". TSO company is set before the obligation to implement new standards to improve the quality of service.

Regarding the supervision of Quality Standards, ERE continuously processed the periodic data submitted by the operators to implement the quality standards from this last one mentioned as well as the problems that may be encountered. These data are reflected on ERE annual reports.

Regarding the supervision of the quality of service standards to the customer, ERE periodically supervised the official website of the licensed operators that provide the electricity customer's service, and brought to their attention all the cases that the service is not provided on these standards. We shall mention here the behavior of FSHU company for the review of the conditions of the Agreement with the Albanian Post Office, after receiving several complaints for the customers regarding the lack of regular service for the submission of the physical electricity invoice at the address, the request of the attention of FSH and DSO companies regarding the access to their internet website, after observing the problems on them, or to bring into attention for all the licensees on the supply activity to comply the obligations for extensive information regarding the rights and obligations of the customer through the internet official website.

(ii) Monitoring for the suppliers on the free market supplier regarding the implementation of the regulation

Regarding this obligation, from ERE structures, it is periodically monitored the compliance of the licensee obligations deriving the Regulation "On the measures of the licensee for the supply service to achieve the metering indicators and assessment from ERE of the service performance to the customers", approved with ERE Board Decision no. 23 dated 14.02.2022.

This decision become effective on 01.06.2022 and its effects for the first reporting purposes included the 1 June - 31 December 2022, while the legal effects initiated on January 2023. On the abovementioned regulation are defined the responsibilities of the suppliers regarding the measures that shall be taken to reach the assessment of the indicators to the performance of customer service.

The obligation of the suppliers to provide information through phone services and any other means, such as making it available on the *website*, at any Customer Care Center, to enable except of the service and information, as well as the preparation of the forms/leaflets that contain information about the supply service or the offers, the measures to facilitate the persons with disabilities to the access of the provided services, etc. ERE issues a greatest importance to the achievement and maintenance of the standards for the quality of service to electricity customers and for this purpose required preliminary information regarding the compliance of the obligations shortly provided above, despite of the regulation.

- (iii)** Some of the licensees that reported at ERE submitted the first draft of the Management Code for the Complaints and Requirement of their customers in the future, based on them shall be prepared the standard forms for different complaints and requirements. It results that from what is required above and according to the reports, the majority of the licensees being on the conditions on which they do not supply any end user based on the "*Regulation on the measures of the licensees on the supply activity to reach the metering indicators and assessment from ERE to the performance of the customer service*" approved with ERE Board Decision no. 23, dated 14.02.2022, article 8 point 1 citing: "This regulation is not applied for the customers that, during the calendar year have bot supplied any end-use customer. *On each case, the suppliers decide to exercise the supply activity shall inform ERE to take the measures to guarantee the compliance of the conditions of this regulation, not later than 15 days from the beginning of exercising the supply activity for the end-use customers.*" "The regulation on the licensee measures for the supply service to achieve the metering indicators assessment from ERE of the performance service to the customer" approved with ERE Board Decision no. 23, dated 14.02.2022.

Supervision of the customer level of information regarding the service

During 2022, ERE is engaged on realizing a session dedicated to customer protection, that is published on ERE official website, specifically <https://ere.gov.al/sq/> under the item Customer Services. This session issues detailed information for the customer and sets on his availability the effective legislation and the mechanisms of the complaint. The customers completed the complaint,

through which expressed the satisfaction and their opinions regarding the received services or the services that they want to receive. Some of the survey questions related to the services received from ERE and the adequacy of the information obtained on the official ERE website are presented below.

The survey is one right and not an obligation for the customer to a smaller number of customers that have completed it. Although during 2023 shall be followed the analysis of the survey data and the opportunity to improve the session, through the survey share twice in a month on social network or the traditional methods of completing the survey.

Recently, through social media networks, a poll has been organized on ERE official website where various questions have been published related to the aforementioned aspects. Some of the questions on this survey are:

Among the following options, which one are you currently supplied to? The options included FSHU, FMF, and Free Market Suppliers, where 91% of consumers have chosen FSHU company.

Where did you address/have you addressed the complaint regarding the electricity supplier? In this question, 50% of the responses referred to the option "To ERE" compared to addressing it directly to the Supplier with 38% or to the competent court with a result of 12%.

Do you think the legislation for consumer rights protection is complete but not implemented or you are not informed? 25% of consumers considered it incomplete, 50% considered it complete, and 25% of them are not informed.

How effective is the information you receive through the ERE website? Based on the given responses, consumers mainly rated the information with the options "Very clear" and "Clear," accounting about 89% of the information they receive through the official ERE website. Meanwhile, 11% of them selected the option "Very unclear".

How satisfied are you with the service you received from ERE? For the options "Very satisfied and satisfied," 85% of consumers considered the service to be such, compared to 15% of them who remained dissatisfied.

11. Development of a tariff reform initiated from the market re-organization and market opening

Regarding the development of a tariff reform initiated from the market re-organization and market opening, this objective is divided into two items:

- (i) Full analysis of the observed issues after the approval of the methodologies and the handle of the solutions for the best international practices on this regard, in cooperation with the international institutions**

ERE during 2022 continued the analysis of the problems encountered not only to the approved methodologies but also the issues initiated during the tariff review processes. ERE handled the need for assistance regarding the other acts or different issues regarding the regulatory system in general, or the issues raised even on the meetings held between ERE, NARUC but even French Expertise. On the current conditions of the electricity market that continues to be highly fluctuate and have causes a crisis on the power sector at the European continent during 2022, we assess that the amendment of the methodologies regarding the market regulation or the regulatory principles in general, shall be performed on a second time, after the stabilization of the electricity price and currently these acts may be reviewed to define some of their composed elements. Among the issues that we may focus for the moment, it is evaluated the need to define the application forms for approving the tariffs from the network operators.

Regarding the above, during 2023 shall be reassessed the opportunity to improve the existing methodologies of electricity transmission and distribution which are related to the definitions issued from the implementation of new RES and NEMO legislation.

(ii) Realization of a study to access the opportunities that lead to the reduction of the customers's costs

Regarding this issue, the conducted researches and the analysis of the power sector situation, not only in Albania but also in Europe, in 2021 and 2022 have been atypical years in terms of electricity procurement costs due to price increases in the free market. The majority of countries have experienced an extraordinary increase of electricity prices, leading to interventions in some cases, of the application of a ceiling price due to electricity market dynamics or imposing a tax on extraordinary revenues to facilitate the impact on household consumers. Cost reduction is now a focus for all countries, and among the key issues remains the construction of new generating sources and their diversification to meet the demand for electricity and consequently reduce costs for end consumers, a need that has been addressed by the Albanian Government through respective decisions. In 2023, ERE aims to analyze the data published by regional associations.

12. Analysis of natural gas market

Regarding the strategic objectives of ERE, as well as the calendar of reviewed measures, approved with ERE Board Decision no. 20, dated 04.02.2022, the natural gas market analysis, is divided in some points:

(i) Identification of the needs and requirements for natural gas. Study analysis on natural gas users in regional countries and the expectations for the Albanian Market.

Regarding the identification of the need and requirements for gas and the study analysis on the users of gas in regional countries and the expectations for the Albanian market, ERE is focused on the study and evaluation of the scenario provided on the strategic document "On approving the national energy strategy for the 2018-2033 period", approved with Council of Minister Decision no.480 dated 31.07.2018, and "The approval of the development plan of natural gas sector in Albania and the identification of priority projects", approved with Council of Minister Decision no. 87, dated 14.02.2018, an obligation that continues even during 2023. ERE remains committed to explore all opportunities for active involvement in the Energy Community projects related to natural gas developments in the Southeast European region.

(ii) Study of the scenario to establish the natural gas supply of the Albanian household and non-household customers,

The study of the Schenario regarding this target is an issue that will continue even for 2023, because it is closely related with the development of natural gas market in our country, that is foreseen even at the National Strategy for Energy (2018 - 2030), according to the Recommendation 2018/01/MC-EnC of the Council of Energy Community Decision.

(iii) Study of the Policies, prices and tariffs

Regarding the study of the tariffs and prices policy at natural gas sector there are performed and are discussed working meetings focusing on the study of published documents from national and international actors that act in natural gas sector like Albgaz and TAP AG companies.

(iv) Assessment of the existing gas network in Albania and the issue of the recommendations for its possible integration to the future national gas system

Regarding the evaluation of the existing gas network in Albania and providing recommendations for its possible integration into the future national gas system, ERE has undertaken several initiatives related to its correspondence with the two main operators in the natural gas sector in Albania. The combined operator, Albgaz company and TAP AG, the Transmission System Operator (TSO) and an Independent Transmission Operator (ITO), enable to interested natural gas transporters in Albania to transport gas, providing the quality and secure services in compliance with the applicable safety standards.

TAP (Trans Adriatic Pipeline) contributes to the energy security of Europe and operates with national and international operational and safety standards. From 31 December 2020, it has transported over 15 bcm (billion cubic meters) of natural gas to Europe.

The Energy Community Secretariat, in its comprehensive report on the gas market in Albania, emphasizes the need for the establishment of operational infrastructure and the establishment of the basis for a functional domestic gas market. TAP contributes to the energy security of Europe in our country.

According to the report, after the set into operation of the Trans Adriatic Pipeline (TAP AG), Albania is officially connected to the gas markets. Albania become a transit country as TAP has started commercial operations and is conducting a market test for its capacity expansion. Recently, Albania promoted an LNG-based supply source for its long-abandoned Vlora Thermal Power Plant (TPP) conversion project. Simultaneously, there is an aim to establish an LNG transit route to Italy through TAP. However, there has been no progress in terms of gas infrastructure development. The Albania-Kosovo Gas Pipeline (ALKOGAP) is a project of interest for the Energy Community (PECI), and the Ionian-Adriatic Gas Pipeline (IAP) is also a project of mutual interest (PMI).

"Albgaz" is the public authority responsible for the transmission, distribution, and storage of natural gas in the Republic of Albania. It manages approximately 500 km of main gas pipelines that were constructed 40 years ago with outdated technology, where corrosion protection measures are minimal.

The gas pipeline network is distributed throughout the western part of Albania and terminates at the ORC (Oil Refinery and Chemicals) in Ballsh. The domestic gas network infrastructure in Albania has a larger coverage compared to the fuel infrastructure. The gas fields stretch from Durrës to Delvina, providing an opportunity for consumers to connect to the network. However, the limited domestic gas infrastructure in some areas is not in operational condition and requires significant rehabilitation work.

During 2022, implementing the respective Order No. 54/2022, was established a working group to "Monitor Albgaz for the implementation of the investment plan for 2021." The monitoring report revealed that the company faced difficulties in achieving this objective, and it was found that the 10-year development plan for the network is under review by a consulting company, which is expected to be issued with a final version by the end of 2022 or early 2023.

There are also held meetings with the representatives of "Albgaz" company Combined Operator and the consultant, where are discussed the issues for the preparation of the document: The investment plan for the last 10 years of "Albgaz" company regarding the investment plan of the distribution and transmission network of Albgaz company.

During 2022 ERE had continuous correspondence with "Albgaz" company staff, to achieve the objective of establishing a comprehensive and adequate network with the requirements and the conditions set from the documents of intergovernmental agreements. The purpose is to extend the pipeline length by five-times and connect it to the international gas network in the region, that remains one of the main challenges for 2023.

During 2023, shall continue the correspondence and cooperation with Albgaz company to complete the obligation issued from the conclusions of ERE monitoring report, to evidence on-site assets and their status, as well as the projects and agreements regarding the establishment and/or improvement of Natural Gas infrastructure.

13. Regional Integration

During 2022 there are realized the duties as follows:

Through joint meetings of MEDREG, AIMS, and the working groups of the Energy Community Regulatory Board (ECRB), are collected information regarding developments in regional markets and incentives for market coupling, such as those between North Macedonia and Bulgaria, Serbia and 4MMC, and other regional initiatives related to the establishment of exchanges, such as those in Montenegro and North Macedonia.

ERE actively participated to the joint working groups meetings composed of the regulators, the Ministries, the Transmission System Operators for the preparation of legislative, regulatory and technical framework for the establishment of common markets. Following these discussions were prepared the draft – agreements.

ERE and ZRRE signed the Memorandum of Understanding for the mutual recognition of the trading and supply licenses, between Albania and Kosovo. On this Memorandum both regulators agreed on the recognition of electricity trading and supply licenses, which shall reduce the administrative and financial costs of the licensees of both countries to operate in both markets establishing the way for facilitation of a market coupling.

Regarding the Control and update of the effective legislation if there are legal obstacles to market coupling process, ERE representatives that are members of the common working groups held with the participation of the regulators and the TSO-s of Albania and Kosovo and during this year are engaged on the discussion process of these groups to evidence the obstacles that may be submitted to the current by-legal legislation.

Regarding the update of the legal framework, for the identification of necessary amendments to the licensing regulations and procedures for the mutual recognition of licenses, as follows approved with the amendments of the Licensing Regulation, approved with ERE Board Decision no. 215, dated 20.12.2019, it continued the work for the mutual recognition of electricity trading and supply licenses, within the implementation of a regional market coupling, with a harmonized legislation between these countries. For this purpose, on 27 December 2022, there were approved the common rules for ALPEX operation between Albania and Kosovo.

14. Defining the Nominated Electricity Market Operator (NEMO) of the coupling with Kosovo

ERE participated at KEP/AIMS project working groups for the establishment of a market coupling between Albania, Italy, Montenegro, and Serbia.

On this framework, the recognition of the Nominated Electricity Market Operator (NEMO) to the exchange commissions with the EU countries is related with the operational commencement of the Albanian Power Exchange (ALPEX) that shall apply for the recognition market operators in Albania and Kosovo.

ERE held a common meeting with the Regulatory Office for Energy of Kosovo, on date 27 December 2022, in Prishtina, to review the Rules and Procedures of the Albanian Power Exchange (ALPEX) and their approval. The approval of these rules paves the way to the effectiveness of the trading platform and is an important step for the establishment of a regional energy market of Western Balkans. From its efficiency shall benefit the Kosovo and Albania Customers but even the region as part of the common incentives.

The finalization of this process is preceded from ERE Board Decision dated 27.10.2022 and the cooperation Memoranda between TSO, KOSTT, ERE and ZRRE for day ahead electricity market coupling. In light with WB6 Memorandum of Understanding, date 21 October 2021, it was signed another Framework Agreement between the TSO, KOSTT, ERE and ERO for the day ahead and intraday electricity market coupling the Albanian and Kosovo Governments are the signatory parties of the Energy Community Treaty and are pledged for the establishment and operation of a competitive and transparent electricity market, for this reason the trade models of both countries provide that through ALPEX shall be implemented the Targetet European Market Model.

ALPEX is expected that on 2023 shall initiate the day ahead market operation in Albania and also initiated the training of traders for electricity training and the *Dry Run* process during which shall be seen the operation approach of this market and the recognition of the parties to the trading processes of the products on this exchange. The role of the regulators shall be the supervision of this process and its successful termination to comply with the obligations undertaken from Albania in the framework of Energy Community Treaty. This process was supported from USAID, a strategic partner of both regulators.

As follows with Board Decision no. 280, dated 01.11.2022, were approved the “Harmonized Rules of SEE CAO Allocation, for the Albania – Greece, Albania – Monte Negro and Albania – Kosovo borders.

15. The operation of the trading processes

The periodic reports of critical infrastructure for Cybersecurity from the companies’ part of the regulation and cooperation even with USAID/NARUC which gradually engaged the technical assistance for ERE regarding this regulation shall be regarding this regulation, it is working for the data processing and the possibility of improvements in the Regulation based on the gained experience.

In this framework it is important that during USAID meetings it is emphasized to take the measures of the regulators that except of the analysis and supervision of the licensees and the maintenance of *Cybersecurity* standards for the Regulator itself. On this point during 2023, shall be worked for the establishment of the internal regulation and the provision of the budget to realize the *Cybersecurity* test on ERE IT.

Our Terms of Reference (TOR) regarding *Cybersecurity* were selected from NARUC for the first round of technical short-term assistance of cybersecurity. NARUC aims to support ERE regarding the regulatory assessments, of preparing the critical infrastructure aiming the termination of the following documents:

- Personalized guideline to access cybersecurity investments using the results of a maturity model.
- Personalized model of risk assessment and guideline.
- Personalized agenda and Planning for continuous updates of the processes and incidents reports.

Through this Technical Assistance that is provided by USAID, ERE staff shall take the experience and shall be able to evaluate the cybersecurity readiness plans submitted from the companies and shall be more prepared to monitor the security and reliability of the Albanian power network and for the advanced best practices of cybersecurity, this shall enable the effective monitoring of critical infrastructure protection of the power network.

ERE participated to the working groups held by ECRB where there are discussed the encountered problems from the implementation of Cyber Security Regulation in Energy Community Countries and wider.

ERE followed the communication with NARUC regarding the full implementation of the regulation for cybersecurity of the Critical Infrastructures to the Power sector.

During 2022 are realized seminars with the participation of market participants and NARUC.

Regarding the implementation of REMIT regulation, ERE actively participated to the working groups of Energy Community Secretariat and the joint trainings of the Secretariat and ERRA regarding the implementation of the regulation and the duties of the parties included on the process. Also regarding the implementation of this regulation ERE staff participated to the regulatory schools organized from the Secretariat regarding this subject.

Regarding the implementation of REMIT regulation, ERE actively participated to the working groups of the Secretariat and ERRA regarding the implementation of the regulation and the duties of the involved parties in the process. Also, for the implementation of this regulation ERE staff participated to the regulatory schools organized from the Secretariat regarding this subject. It is also thought that with Secretariat assistance shall be held a seminar with the participation of the market participants to exchange the experiences on this regard and to explain the operational approach of the Regulation and the duties of the parties from its implementation.

It was held a long training with the representatives of CRE, France, part of the cooperation program with the French Agency for Development. During this meeting were exchanged the experiences with the representatives of the French regulator regarding the measures undertaken for market monitoring, the conditions that shall be completed by the licensees and the investigation approach for the domestic market also the investigation cases of the common market. At the end of the training the French representatives drafted a report that served for ERE specialists for the work improvement regarding the market monitoring.

In this framework it is necessary and shall be seen the automatization opportunity through the online platforms from ERE official website where the market participants shall fulfill the registration forms of REMIT or to issue the necessary data for the implementation of the regulation and other data necessary for ERE periodic reporting.

To realize this operation, it is necessary to adopt ERE webpage or the establishment of a *database* for market monitoring even during 2023 shall be seen the opportunity of this adoption.

16. Implementation of market coupling Albania – Kosovo

Regarding this duty it is aimed that during 2023, shall be continued the work with Energy Community Secretariat for the implementation of CACM in regional countries. Through the training platform of the Balcan Energy School established with the participation of Italy, Monte Negro, North Macedonia and Bosnje Hercegovina, shall be seen the opportunity to control the national legislation with the legislative barriers between the countries to eliminate them.

17. Transparency and integrity in administrative activity

When it comes to involvement of stakeholders in determining the strategies and regulatory policies, can be said that ERE has shown an increased focus on consulting with a growing number of stakeholders, including the work practice of the regulator and ERE announcements and decisions through the social media to inform as many stakeholders as possible, especially those that cannot be identified through conventional written methods.

Furthermore, with ERE Board Decision no. 220, dated 01.09.2022, it is approved the methodology for impact analysis of regulatory acts of the Energy Regulatory Entity.

This methodology contains some general guidelines how ERE aims to implement the influence analysis of the regulation regarding its responsibility area, as provided on Law no. 43/2015 and Law no. 105/2015. Implementing these laws, ERE performs the supervisory and regulatory operations, (the approval of the acts, regulations, methodologies), setting the tariffs, licensing the entities. The methodology aims to handle the approach of evaluating a regulatory decision, regarding the parties directly affected by these acts, to verify if a regulatory intervention is necessary and effective. This is performed through describing objectives, identifying issues, comparing alternative options, assessing benefits and costs for market participants, and evaluating positive and negative effects on regulatory processes.

On this methodology it is provided the analysis of the regulatory impact that shall be partially subject to the regulatory acts for:

- Defining the prices for the end-use customers for a new regulatory period;
- Defining the quality of service for a regulatory period;
- Amendment of the universal service conditions;
- Total expenses of regulation;
- Access to the electricity market.

Regarding the publication of the decisions, the reports and applications it results that there are published on ERE official website all ERE decisions for 2022 and also the application reports or the applications for defining the tariff from the Regulator.

Regarding the establishment of permanent consultative structures such as common commissions of the stakeholders that shall serve to the decision-making, during 2022 it is worked in drafting the rules for the selection of consultative structures and it is aimed that for 2023 shall be approved a document paving the way for selecting the permanent commissions that shall serve as a independent opinion protecting the interests of the third parties reaching a decision-making process supported by full involvement of the stakeholders.

Regarding the task related to studying best practices for assessing the effects of regulation with the support of academic experts and other experienced professionals in the field, the aim is to accomplish this task during the year 2023.

Regarding the planned target in the action plan for monitoring and implementing ERE's strategic objectives, the study and review of whether the electricity market is operating to ensure efficient trading transactions, the establishment of a working group is foreseen during the year 2023 to fulfill the aforementioned task.

Law no. 43/2015 “On Power Sector”, as amended, defined the obligations of the network operators as well as ERE in the process of drafting, reviewing, approving and implementing the network codes. Regarding the implementation of these legal obligations, ERE shall continue to require the engagement of the network operators for the administration of the respective codes. The administration part of the network codes is evaluated that shall be performed by the network Operators to make the respective proposals at ERE regarding the drafting, amendment of these acts that may lead as result of legal requirements, but even as the need of adoption for network development that these operators manage. ERE according to the effective legislation, reviewed and evaluated performing the respective approvals and proposals of the network operators of the amendments or approvals of these Codes, in line of developing these norms from ENTSO-E as well as the respective transpositions of the Energy Community. Additionally, within the framework of code administration, reports on network code administration and the compliance of network users with the respective codes have been assessed.

Regarding ERE objectives for 2023, they relate to the finalization of the undertaken measures and those that shall be approved to comply with the objectives identified as follows:

- **Raising consumer awareness to become knowledgeable customers in evaluating offers, understanding the proper operation of market mechanisms, and enabling them to actively participate in electricity supply-related services;**
- **Encouraging the adoption of electric vehicle technology.**
- **Customer’s sensibilization on electricity rationalization.**
- **Defining the metering indicators and performance assessment of the service to the customers that is guaranteed by any licensee in the supply service;**
- **Implementation of a tariff reform initiated from the re-organization and market opening;**
- **Market analysis for natural gas;**
- **Regional integration;**
- **Strengthening access to information for the correct operation of the market processes;**
- **Operation of market processes.**
- **Implemetation of market coupling for Albania – Kosovo;**
- **Transparency and integrity in administrative activity.**

REGARDING EU PROGRESS REPORT RECCOMENDATIONS FOR 2022

The recommendations of the EU progress report for 2022 referring to chapter 15 "Energy" are as follows:

Shall be provided that the Albanian Power Exchange and the electricity day ahead market are fully operational and shall continue to be strengthened the electricity transmission network;

Shall be finalized the operational unbundling of the electricity operators and shall be provided full access to the liberalized market for all customers connected to the 20kV voltage level for 2022, as well as the progressive expansion of this access for all customers;

Shall be implemented the National Electricity and Climate Plan (NECP) updated for 2020-2030, including the action plans for renewable energy and energy efficiency, shall be ensured to be effective all the possible institutional and legislative measures, as well as the financing, certification and audit ones, regarding the transition of electricity production from renewable sources beyond the hydro-power plants considering the electricity crisis.

Shall be used the benefits of regional guarantee of origin system of Energy Community and shall be signed the direct agreement with the service provider to use the national electronic register for the guarantee of origin issue, cancellation and trading, according to EU standards;

Regarding what is provided on these recommendations, shall be informed that ERE during 2022 regarding point 1 of the recommendations completed the necessary regulatory framework regarding the Albanian Power Exchange activity, by approving with ERE Board Decision no. 347, dated 27.12.2022, the new electricity market rules, together with the Regulatory Office for Energy in Kosovo. These rules, together with the respective amendments of the electricity market model, enable the operationability of the Albanian Power Exchange during the first six months of 2023.

Regarding point 2, finalization of operational unbundling of the electricity operators, shall be mentioned that currently this is a closed process with DSO and FSHU companies and during 2022 they continued to develop independently from each other the respective activities, according to the licenses that they held respectively according to ERE Board Decision no. 216/2018 and the one no. 164/2019. With the approval of the contract for the service provision from the comply service of DSO company, approved with ERE Board Decision no. 343 dated 21.12.2022. As follows during March 2023, was approved the proposed compliance officer that finalizes the operational and legal unbundling process of DSO from the Universal Service Supplier (FSHU company). Regarding the opening of the electricity market for the customers connected in 20/10/6 kV medium voltage, we inform that from 1 January 2022 for these customers are completed the technical conditions for the issue to the liberalized market and as consequence they are transferred to be supplied from the Supplier of Last Resort for a 2-year period, implementing the provisions of point 6, Article 86 of Law no. 43/2015 “On Power Sector”, as amended.

Regarding the recommendations of Point 4, shall be informed that ERE during 2022 has been part of all workshops held in the framework of raising the regional system of the guarantee of origin to the Energy Community and is engaged with Energy Community Secretaria to sign the agreement with the service provider. On this framework, ERE provides to implement this system within the first 6 months of 2023.

Regarding point 3 of the progress report recommendations for 2022, Chapter 15 “Energy”, shall be informed that the update of the National Plan for Climate and Energy for 2020-2030 period is not on ERE responsibility. ERE gave its contribution as part of the international working group held for implementing this plan and is ready to give its contribution even for the update of the National Plan for Energy and Climate 2020 – 2030.

On this framework, shall be evaluated that ERE activity during 2022 is developed in the framework of the recommendations of the progress report for 2022 for Albania, that is approved by the European Commission.

1. POWER SECTOR

1.1 Situation of the Albanian Power Sector

The Power system in the Republic of Albania consists of: electricity production, transmission and distribution, electricity trading, to supply the electricity customers. These activities are exercised by entities licensed pursuant to Law no. 43/2015 "On Power Sector", as amended.

Electricity production is realized by public company KESH s.a and Lanabregas HPP with 100% of state shares, as well as by private entities licensed in this activity such as: Priority producers, Independent producers and electricity self-producers.

Electricity transmission is realized by "Transmission System Operator" (TSO) company, which is a company with 100% of state shares. In conformity with article 58 of a Law no.43/2015 "On Power Sector", as amended, the Transmission System Operator (TSO company) is certified and licensed for the operation of the electricity transmission system.

Electricity distribution is realized by " Distribution System Operator" (DSO) company, which is a company with 100% of state shares, established from the allocation of OSHEE company and is licensed for the operation of the electricity distribution system. At the same time ERE based on articles 16 and 72, of Law no. 43/2015 "On Power Sector", as amended, as well as article 15 of the "Regulation on ERE organization, Operation and Procedures" with Decision no.57 dated 21.12.2020 decided the approval of the Compliance Program for the DSO company.

Below it is submitted the Albanian Power System Scheme as well as the Scheme of Electricity and Commercial Flow.

POWER SYSTEM SCHEME

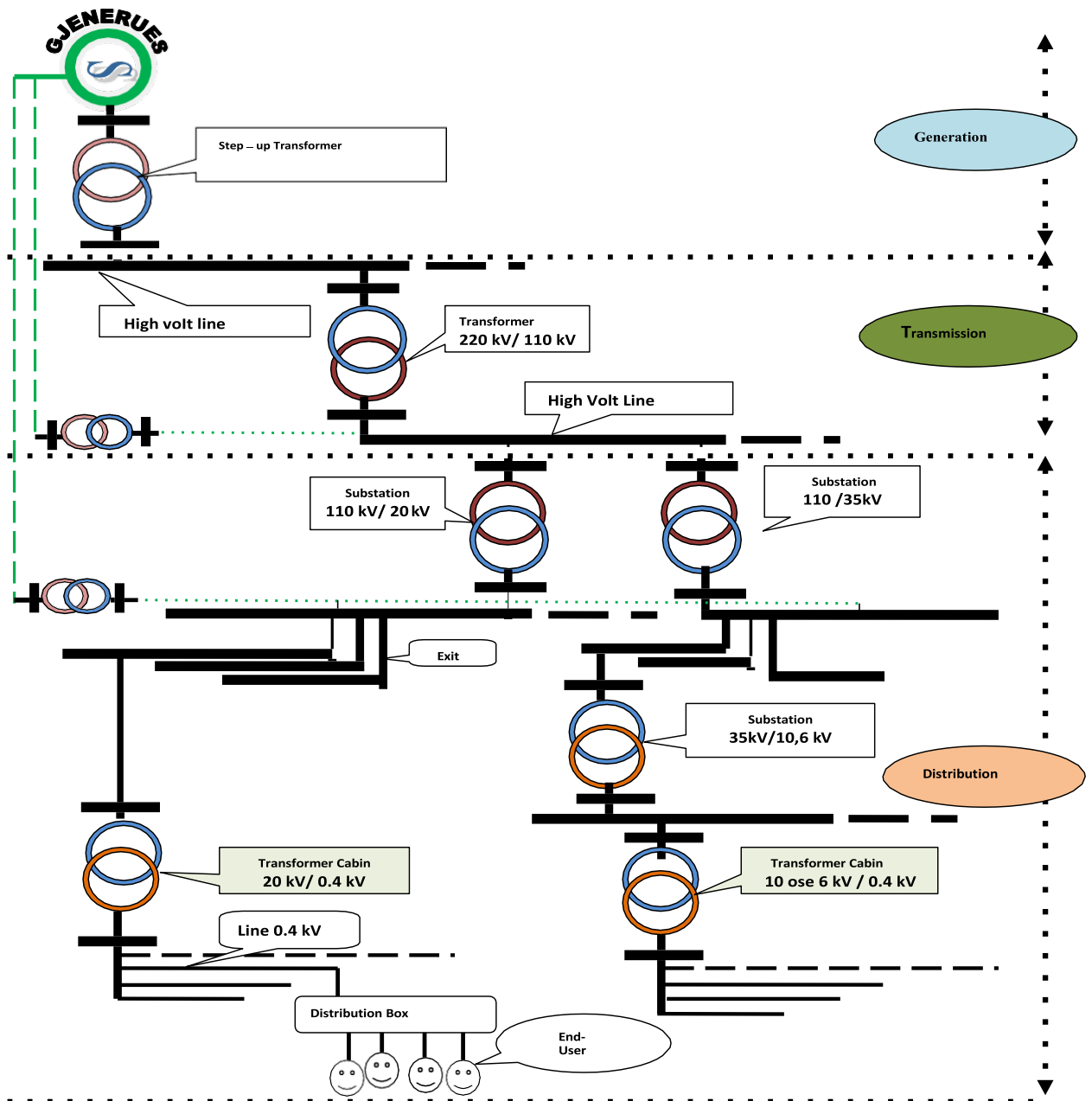

Figure 1 Power System Scheme (Source: ERE)

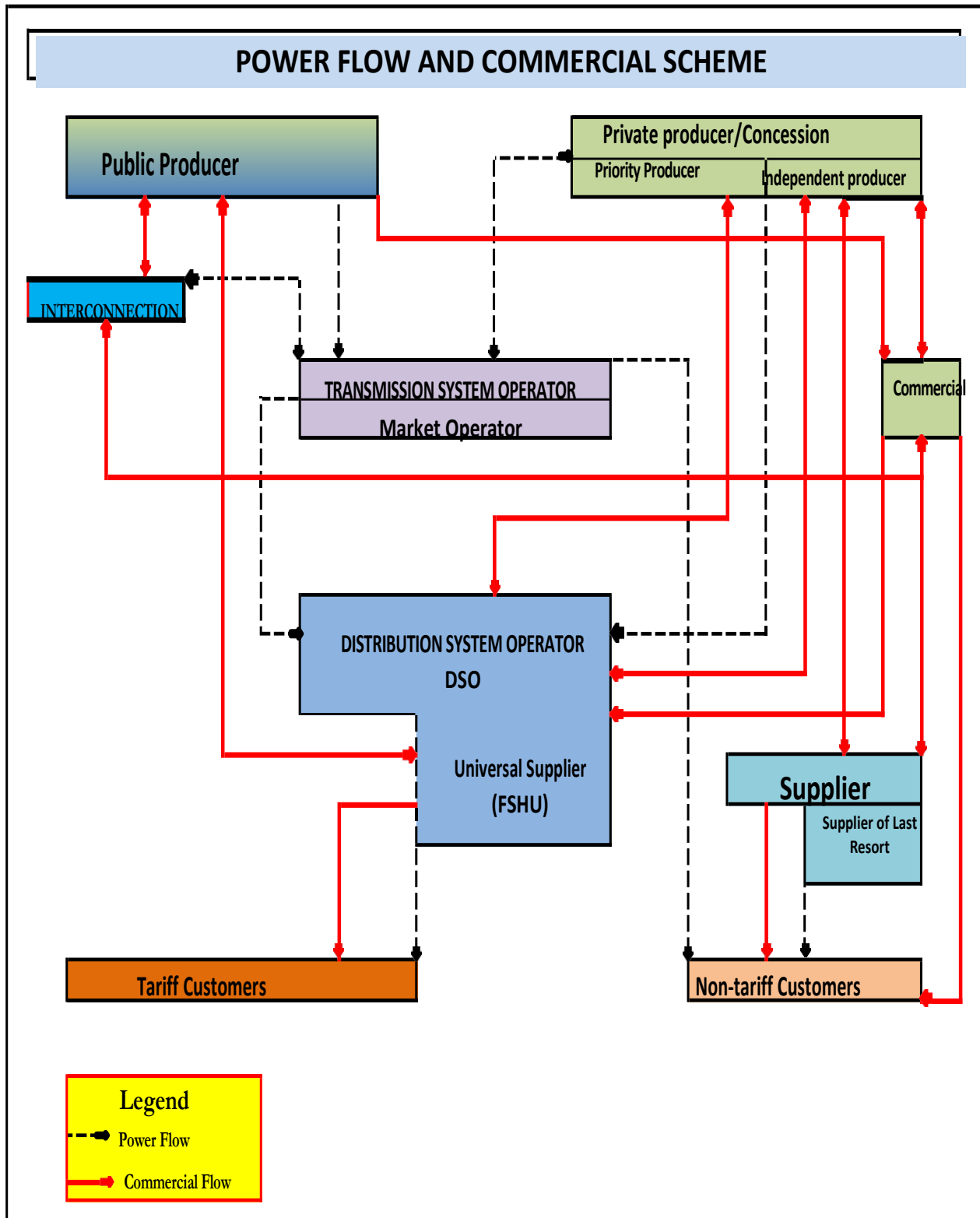

Figure 2 Power Flow and Commercial Scheme (Source: ERE)

The above scheme of the electricity and commercial flow in power sector for the 1 January 2022 until 29.06.2022 period is based on the definitions of Council of Minister's Decision no. 244, of date 30.03.2016 "On approving the conditions for setting public service obligation that shall be implemented to the licensees in power sector which perform the electricity generation, transmission, distribution and electricity supply activities", as amended.

For the 30.06.2022 until 31.12.2022 period, the operation scheme of the Albanian Power System is based on Council of Minister Decision no. 456, dated 29.6.2022, “On approving the conditions for setting public service obligation, that shall be implemented to the licensees in power sector, that perform the electricity production, transmission, distribution and electricity supply activity”. Beginning from October 2021, the Council of Minister Decision no. 584, dated 08.10.2021, decided “To announce the emergency situation of electricity supply”, until on 15 Prill 2022, as follows with Council of Minister Decision no. 650, dated 10.10.2022 on some additions and amendments at Council of Minister Decision no. 584, dated 08.10.2021, "To announce the emergency situation of electricity supply", it is decided the postponement of the emergency situation for electricity supply until 30 June 2023.

Decision to announce the emergency situation for electricity supply comes as the result of the general situation of electricity prices increase at the international markets. This decision gives the government the opportunity to intervene with financial instruments being them administrative instruments to confront this situation.

1.2 ELECTRICITY PRODUCTION

The electricity production is realized from public and private companies licensed for this activity. The public companies are KESH company and Lanabregas HPP with 100% of shares owned by the state, from private entities licensed on this activity: Priority Producers, Independent Producers and Electricity Self Producers, that perform the electricity production activity according to Law no. 43/2015 “On Power Sector”, and Law no. 7/2017 “On the promotion of using energy from renewable resources”.

KESH company, is the biggest production company in Albania with a state-owned capital. KESH is charged with the public service obligation for the 1 January 2022 until 29.06.2022 period based on Council of Minister Decision no. 244 dated 30.03.2016, as amended, while for the 30.06.2022 until 31.12.2022 period holds this obligation based on Council of Minister Decision no. 456 dated 29.06.2022, “On approving the conditions for setting public service obligation, that shall be implemented to the licensees on power sector, that perform electricity production, transmission, distribution and electricity supply activity”.

On this situation KESH company as the entity charged with public service obligation for the electricity supply of the Universal Supplier company with the announcement of the emergency situation of electricity supply with Council of Minister Decision no. 584, dated 08.10.2021 as amended, covers the losses to the transmission network as well as a part of electricity losses in electricity distribution network.

For the period covered by this decision it is provided that KESH company to manage the cascade and the necessary provision with electricity for the supply of the customers in the regulated market performs the procedures according to this decision for the storage and exchange of electricity surpluses, only after completing the need of the Universal Service Supplier. Based on this decision, the electricity surpluses of the public producer is the electricity quantity that remains after full supply of the needs of the Electricity Universal Supplier and the losses to the Distribution System Operator. Also as provided on this decision, the electricity public production company has the right for financial optimization of the cascade only when this does not violate the necessary quantity for

the supply of the Universal Service Supplier and only within weekly or monthly periods. Priority generators and independent electricity generators are entities licensed by ERE throughout the years that utilize the existing or new plants, mainly through privatisation agreements, concession agreements or contracts for the utilisation and administration of electricity production plants.

The total capacity of electricity production installed in our country until 31 December 2021 is 2,614 MW. This capacity is increased in 2022 with about 9 MW compared to 2021 period.

Total electricity production capacity of the public KESH company is 1448 MW and occupies about 55.4% of the total capacity installed in our country.

Total installed capacity of other electricity generators is 1166 MW and occupies about 44.6 % of the total installed capacity in our country.

1.2.1 Electricity production for 2022

The total net domestic production of electricity realized for 2022 is **7,002,645** MWh, from which:

3 859 730 MWh is produced from the plants owned by the public company KESH

3 142 920 MWh is produced from other plants.

Electricity production realized for 2022 by KESH company occupies 55.11 % of all electricity production in our country and electricity production from other producers occupies about 44.89 %.

On the same period during 2021 the electricity production realized by KESH company occupies 59.6 % of the electricity production in our country and electricity production from other producers occupies about 40.4 %.

As evidenced for 2022 there a decrease of KESH company contribution in electricity production realized with about 4.5 % compared to 2021 period.

Centralet e prodhimit të energjisë elektrike janë të lidhura si në rrjetin e transmetimit të energjisë elektrike ashtu dhe në rrjetin e shpërndarjes. Kapaciteti i instaluar i centraleve të lidhura në rrjetin e transmetimit gjatë vitit 2022 është rreth 2,266 MW dhe prodhimi neto i tyre ka rezultuar të jetë 6 149 229 MWh.

Electricity production plants are connected with the electricity transmission and distribution networks. The installed capacity for the plants connected in the transmission network during 2022 is about 2,266 MW and their net production resulted to be 6 149 229 MWh.

The installed capacity of the plants connected in the distribution network during 2022 is about 348 MW and their net production resulted to be 853,414 MWh.

DATA ON THE PRODUCERS FOR 2022 PERIOD		Network	Number of the Entities	Number of the Plants	Installed Capacity (MW)	Production for 2022 (MWh)
P.Pub	Public Producers (Charged with Public Service Obligation)	Connected to the TSO	1	4	1,448	3,859,731
Indep. Prod	Independent Producers (Producers in the open market)	Connected to the TSO	4	9	438	1,159,094
PPE	Priority Producers (Benefit from the Supporting Schemes) + Ashta	Connected to the TSO	33	48	380	1,130,403
	Priority Producers (Benefit from the Supporting Schemes)	Connected to the DSO	133	171	325	803,324
	Priority Photovoltaic Producers (Benefit from the Supporting Schemes)	Connected to the DSO	12	12	23	50,093
			183	244	2,614	7,002,645

Figure 3 Data on the producers for 2022

On the above figure are submitted the data of electricity production for all categories of producers that are operating

At the same time on the below figure it is submitted the net domestic production for 2022, evidencing the electricity production contribution of KESH company, as the public producer and the contributions of other producers. The production realized from the public company KESH s.a, occupies the main weight for the domestic production even during 2022.

Net Domestic Production for 2022 (MWh)	2022
HPP-s / Independent Producers of Electricity to the DSO Grid	777,899
HPP-s / Independent Producers of Electricity to the TSO Grid	894,128
Independent HPP-s to the TSO grid	1,159,097
Lanabregas HPP	25,423
Ashta HPP	236,275
Photovoltaic Plants	50,092
Production from KESH company HPPs	3,859,731
Domestic Total 2022	7,002,645

Source TSO company; KESH company; FTL company

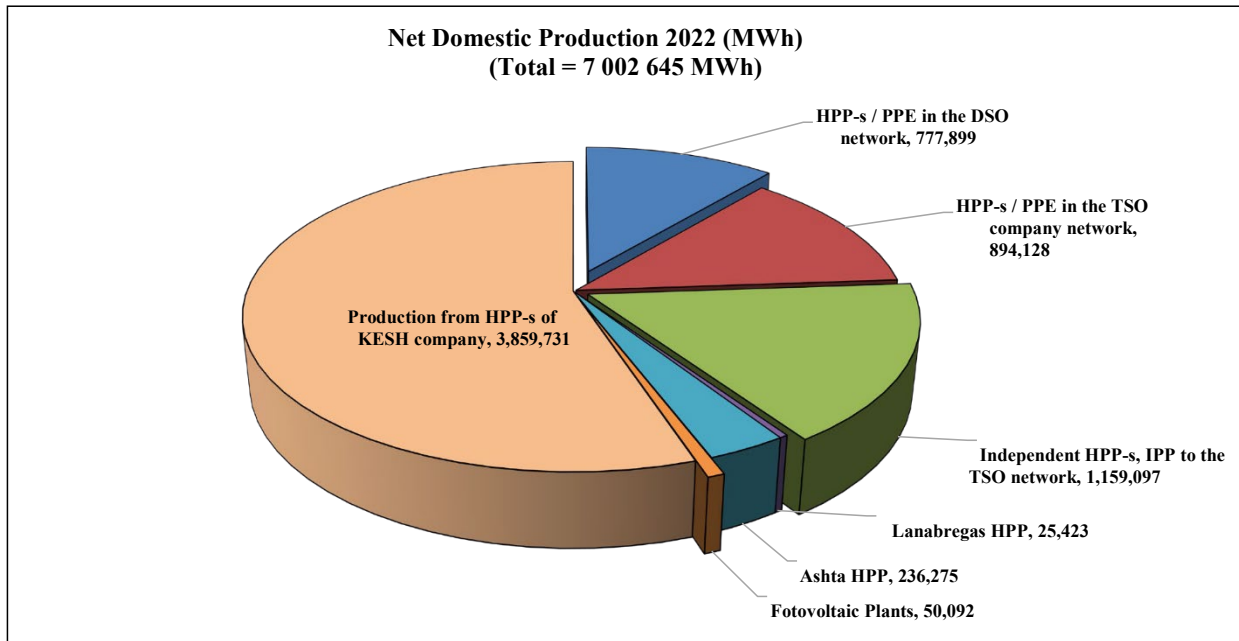

Figure 4 Net domestic production for 2022

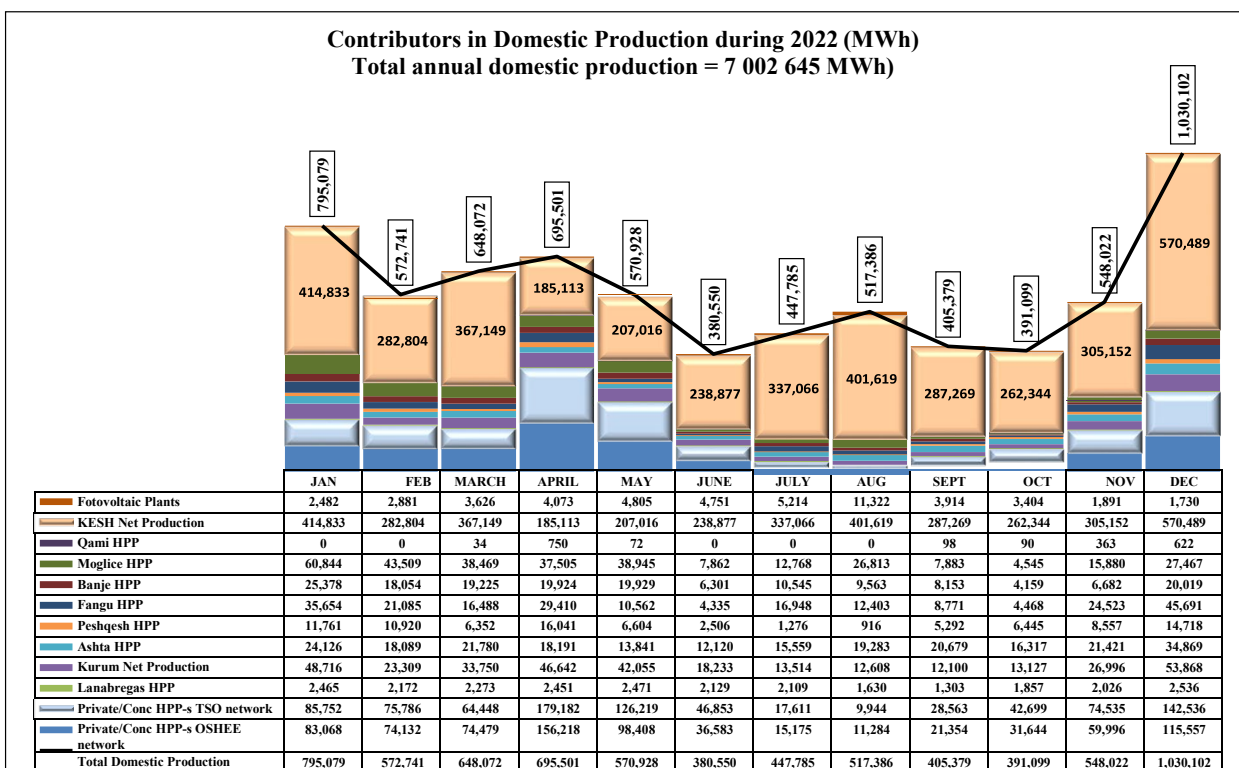

Figure 5 Contributors in domestic production during 2022 (MWh)

The figures below show the comparison of the net monthly production of electricity during 2022 with the average production of the 2009 – 2022 period.

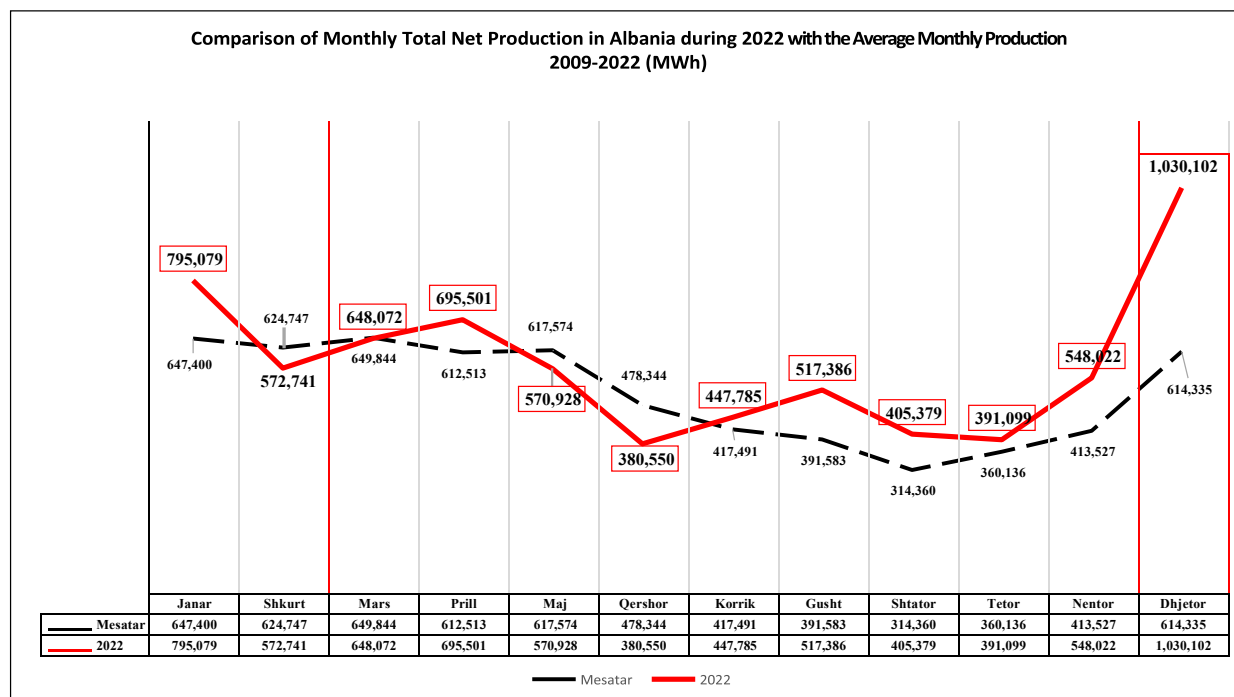

Figure 6 Monthly domestic production for 2022 compared to the average of 2009-2022 period

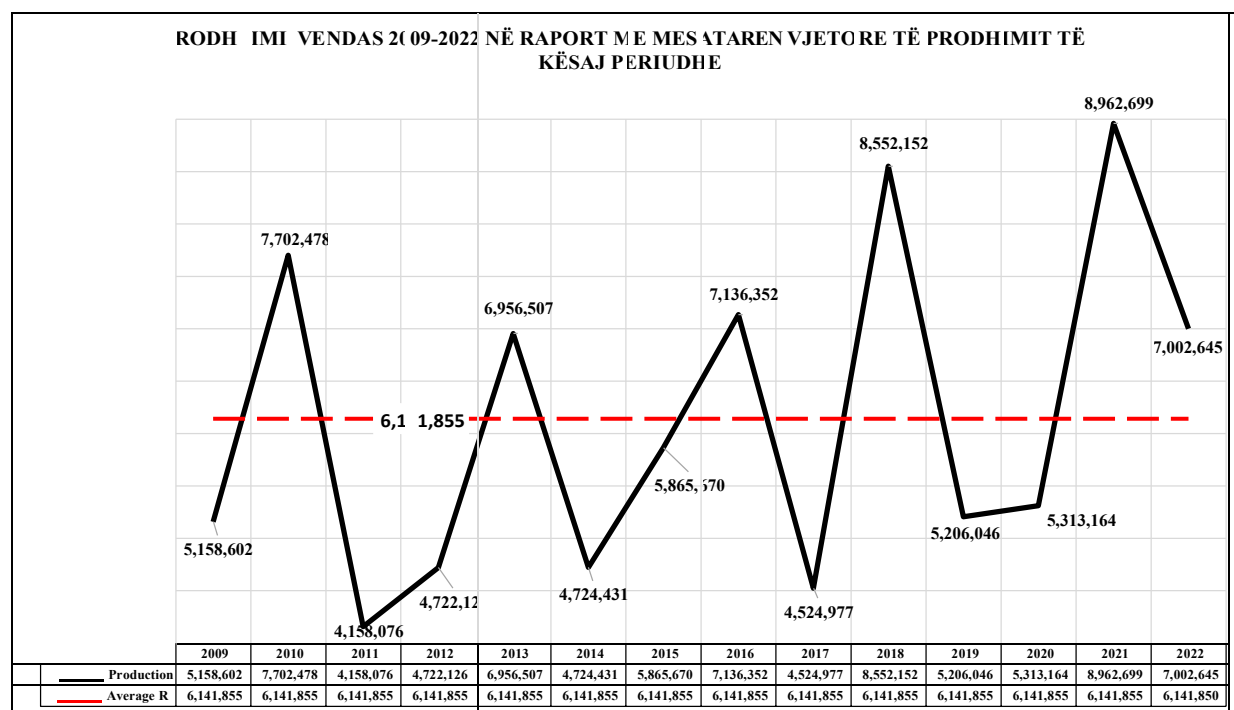

Figure 7 Net domestic historic production for 2009-2022 period regarding the average production for this period

From the historical analysis of electricity production registered in the country, 2022 with the quantity generated of 7,002 GWh is over the electricity average production for 2009 – 2022 period. The electricity average production for 2009 – 2022 period resulted 6,142 GWh. The realized production for 2022 period is about 861 GWh or 47.5% higher than the average production for 2009 – 2022 period. Considering the total electricity consumption for 7,924 GWh, the total generation realized during 2022, has been not sufficient to cover the request, and as consequence there are realized the electricity imports to ensure the electricity supply of all customers.

The monthly maximum production of electricity for 2022, is marked on December 2022 **1,030,102** MWh quantity. This production is realized from the plants under KESH company administration to **55.4 %** measure, while the monthly minimum production of electricity during 2022 was during June 2022 **380,550** MWh quantity.

On the graph it is evidenced that 2022 is considered as a good metrological year and from electricity production view for this year resulted **7,002** GWh quantity, that means **861** GWh more than the average electricity production for 2009 – 2022 period. Considering the fact that electricity production of our country is mainly based on hydro resources, on the good hydrological years like 2022, the electricity production is higher than the multi-year average in 2009 – 2022 period.

The electricity production for 2021 resulted in 8,962,699 MWh quantity, so higher than the multi – year average and significantly higher than the electricity production for 2022. Electricity production for 2022 resulted in 1,960 GWh quantity lower than the one realized during 2021.

1.2.2 Main technical data and electricity production from the public production plants for 2022

Public company KESH owns three HPP-s of Drini River cascade as well as Vlora TPP, Qyrmaq photovoltaic plant with 5.14 MWp. The composition of the plants group from KESH company and the installed capacity of each of them is submitted with the data as follows where it is evidenced the number of the aggregates, installed capacity for each aggregate and the installed capacity for each plant.

	Fierza	Koman	V.Dejes	Vlore
No of the Aggregates	4	4	5	2
Aggregates capacity MW	125	150	50	70+28
Installed capacity of the plant MW	500	600	250	98
Total capacity MW	1448			

Figure 8 Structure of Electricity Plants of Public Production (Source: KESH company)

The total installed capacity owned by KESH company, reaches to 1,448 MW, of which the installed capacity of HPPs in Drin River cascade is 1,350 MW, of Vlora TPP 98 MW and the photovoltaic plant Qyrmaq 5.14 MWp.

2022 is allocated in two parts: The first 8-months that is a dry period and the latest 4-months with considerable events and inflows compared to the first period of 2022.

The first 8 – month period of 2022 was characterized from a unfavourable water situation and at the same time quite challenging due to the emergency situation of electricity supply, caused from the global energy price crisis. In general water indicators are not only lower compared to the respective wet period of 2021 but also below the long-term average indicators from 1993 to 2021. However, the last 4 – months of 2022 was characterized by precipitation and a wet weather pattern, which resulted in increased inflows to the hydropower plants in the Drin River Basin.

Unlike from 2021, where the first half of the year was wet and the second half was dry, 2022 was characterized by a dry weather pattern in its first half, while the last 4 months (especially during November – December period) was a wet weather.

The average **inflows** during the first 8 months of 2022 resulted 141 m³/s at Fierza lake. The lowest 51% indicator compared to the same period of 2021 that was of about 287 m³/s.

This was due to the prolonged dry period and the lack of the rains. The average inflows in Fierza lake for the first 8 months of 2022, of about 141 m³/s, are calculated to be 28% lower than the long-term average (1993-2021) of 195 m³/s.

During the last 4-months of 2022, the inflows at Lake Fierza were around 237 m³/s, whereas for the same period in 2021, they amounted to approximately 125 m³/s. This increase in inflows during the final months of 2022 may be attributed to the significant rainfall that occurred during this period.

The average inflows of 2022 are over 172 m³/s, or 26% lower compared to 2021, that were of about 233 m³/s. While compared to the 20-year average of about 181 m³/s are 5 % lower.

The level at Fierza lake on 21 December 2022 resulted on 291.92 meter over the sea level quota (mmnd), compared with 2021 that was 273.96 m, so for 2022 the level of the water at Fierza lake is about 17.96 m, more.

The average level 20- annual for December on Fierza lake is about 276.98 m, compared to 2022 we are +14.94 m this as result of the large water flows during November and December.

The average level of Fierza utilization during resulted about 276 m, compared with about 284 during 2021, so about 8 meters lower.

Energy Reserve at the beginning of 2022 was 624 GWh while at the end of 2022 was 1,193 GWh. During the year except of the production and administration of the flows it is accumulated the 569 GWh energy reserve. The average energy reserve during 2022 was 661 GWh or 28% lower than 2021 (922 GWh).

Gross Production in total for 2022 results about 3,892 GWh or -28% lower compared to 2021 that resulted about 5,393 GWh. Compared with the 20-year average which is about 4,291 GWh, the production of 2022 resulted 9 % less.

Referring to the above indicators it resulted that in general 2022 was drier from water point of view compared to 2021, bringing lower production.

KESH company from 12 May 2022, initiated the official operation of the photovoltaic plant Qyrmaq dam (Vau i Dejës HPP), with installed capacity 5.143 MW, as a diversified primary resource that is added to the generation portfolio of the Company. During 2022 this plant generated 4,203 MWh of electricity.

The net production from the production plants of KESH company for 2022 resulted to be 3,859,730 MWh, composing about 55.1 % of the net total production during this year. The gross production is realized in 1,855 GWh measure from Koman HPP, 1,101 GWh from Fierzë HPP and 936 GWh from Vau i Dejës HPP. Koman HPP resulted to be the largest contributor of electricity production in Drini river cascade.

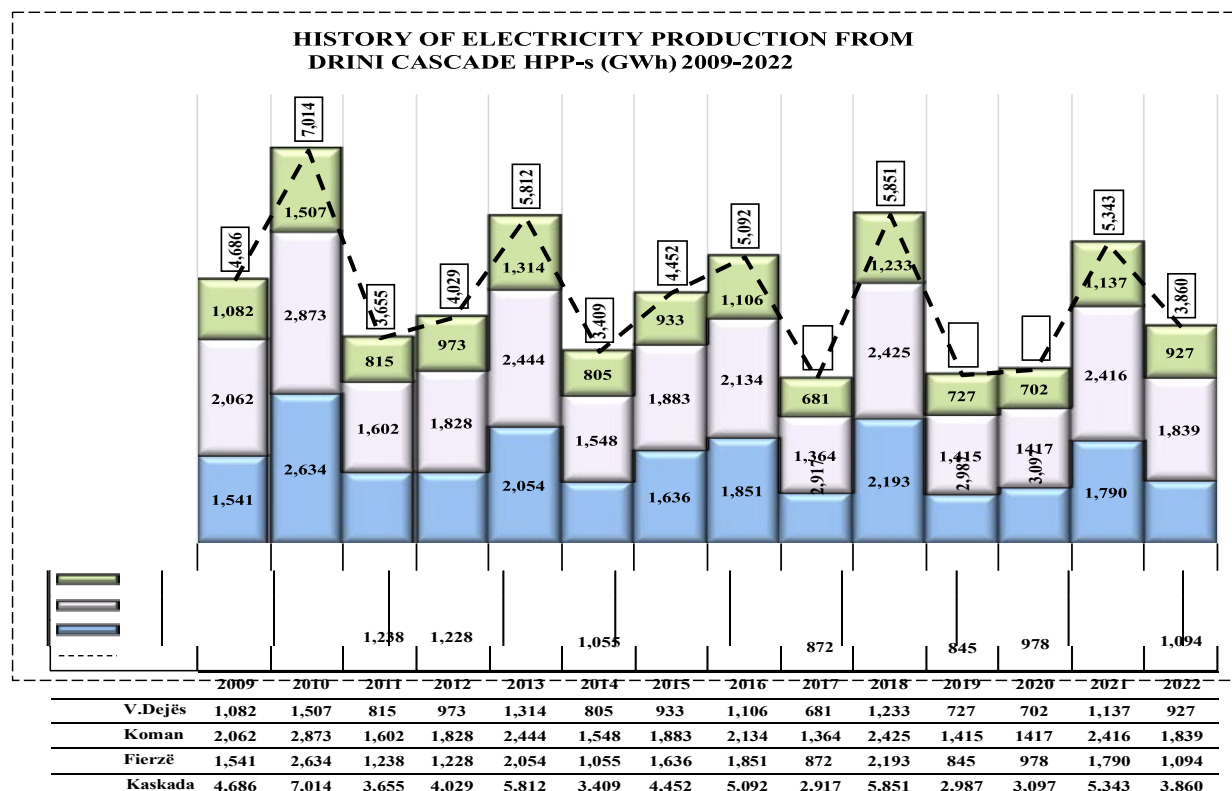

Figure 9 History of Electricity Production from Drini Cascade HPP-s

(Source: KESH, TSO companies)

The maximum electricity production realized from KESH company for 2009 – 2021 period is reached on 2010, 7014 GWh quantity. The electricity production for 2010 was 3,154 GWh higher than the electricity production achieved during 2022 which results in 3,860 GWh quantity. This indicator, is submitted clearly in the higher level of dependence for hydrological conditions and as consequence the existence of hydrological risk on the stability of electricity production in our country. The dependence of electricity production because this production is based on hydro resources makes necessary the diversification of electricity production resources in our country.

As follows in a detailed way it is submitted the monthly electricity production from the hydro-power plants of Drini River Cascade in KESH company administration.

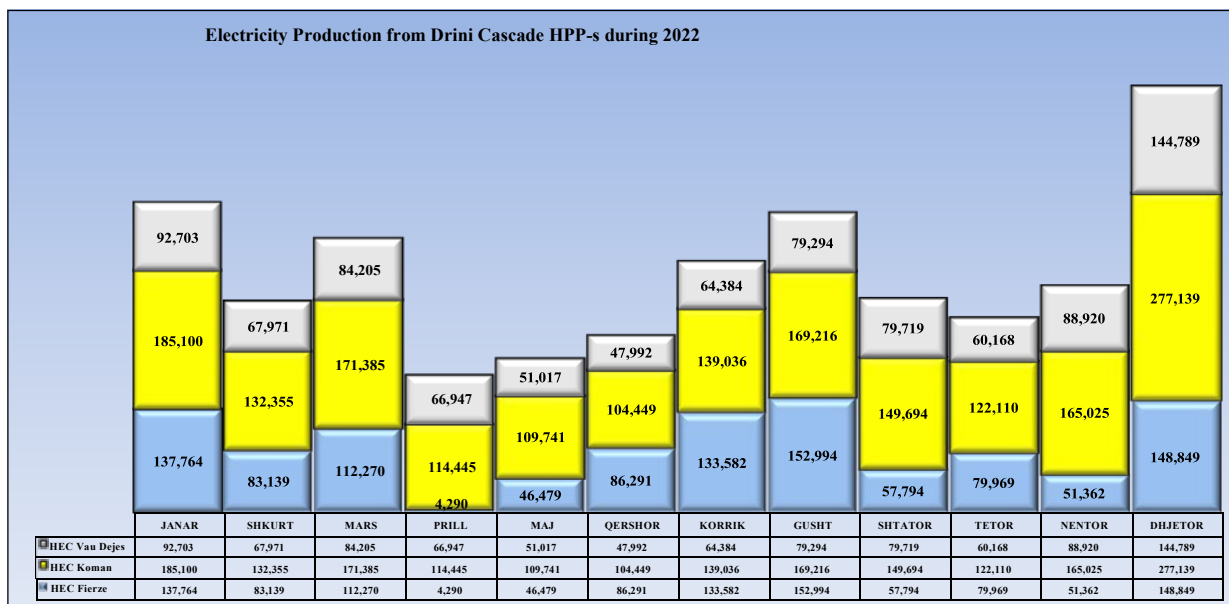

Figure 10 Electricity Production from Drini Cascade HPP-s during 2022

(Source: KESH, TSO companies)

The maximum production of KESH company is registered on December 570,777 MWh quantity, and minimum on April 185,682 MWh quantity. As evidenced the difference between maximum production realized on 570,777 MWh quantity and the minimum realized on 185,682 MWh quantity for 2022 follows to be considerable respectively on 385,095 MWh quantity. Even this indicator identifies the dependence of electricity production in our country from the hydro resources.

On figure 11, are graphically submitted the water discharges without electricity production from KESH company HPP-s in Drini Cascade, for each year of the 2002 – 2022 period.

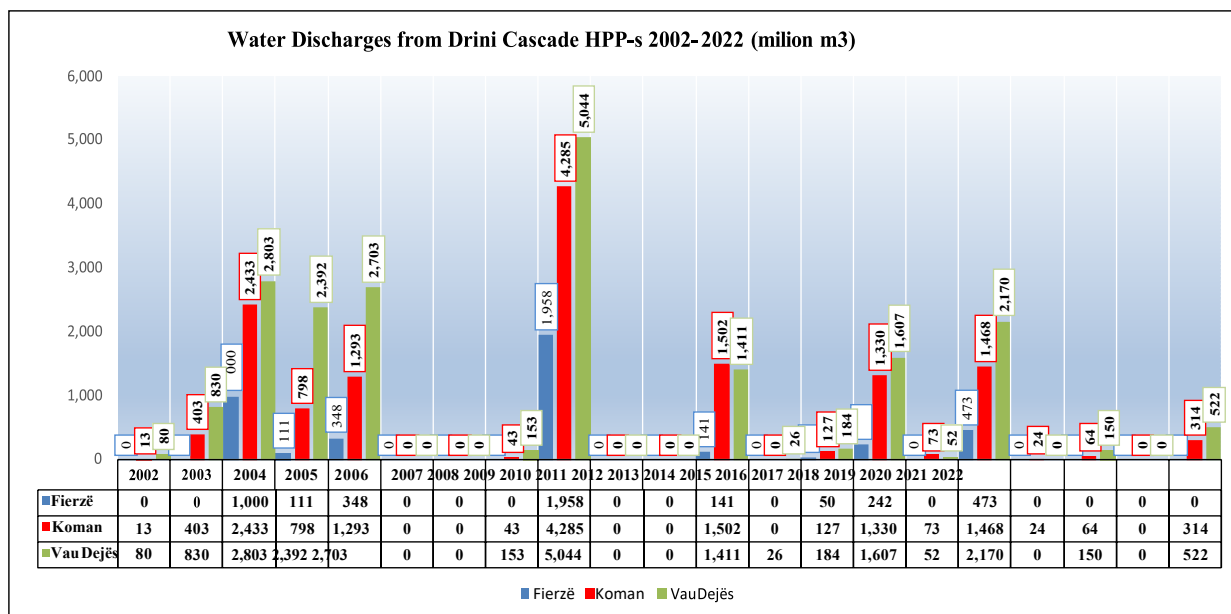

Figure 11 Water Discharges from Drini Cascade HPP-s (2002-2022) (Source: KESH company)

KESH company reports that during 2022 on its complexity was characterized by a favourable hydro situation as consequence of the intensive rains and the largest inflows during the last year. The average inflows during 2022 are over 172 m³/s, or 26% lower compared to 2021, that were 233 m³/s. While compared to the 20-year average of about 181 m³/s are less.

On the following table are submitted the data for the level in meters of Fierza Lake for 2022 by the end of each month.

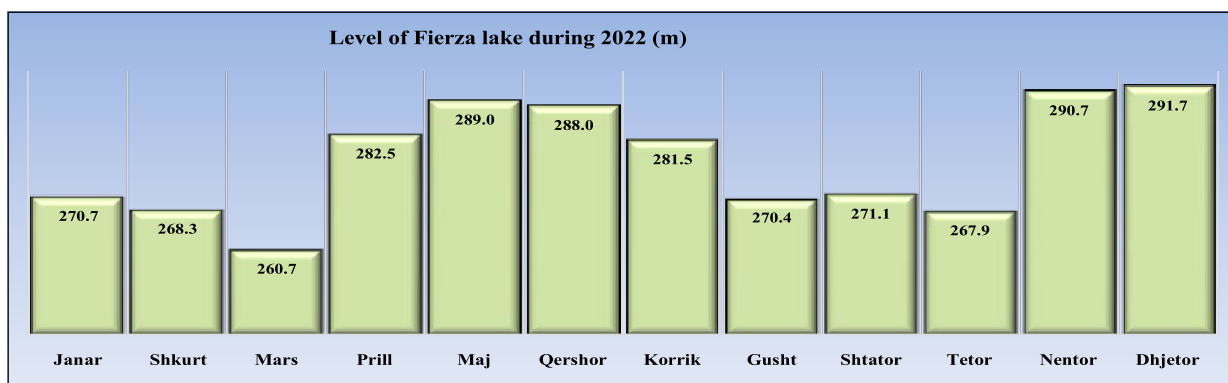

Figure 12 Level of Fierza lake during 2022 (m)

(Source: KESH company)

Fierza HPP basin is the largest water basin of Drini River Cascade and serves as an annual regulator of the hydro reserve of Drini river cascade. The level of the water in Fierza basin directly influences on the utilization of the cascade of Drini river. As evidenced from the above data, by the end of December 2022, the level of water in Fierza lake has been on maximum quota of the year 291,7 meter. This is the maximum level of December for the 1991-2022 period.

The historical data over Fierza HPP for 1991 – 2022 period are submitted as follows evidencing the minimum and maximum quota.

	FIERZA LEVEL 1991-2022											
	Jan	Feb	March	April	May	June	July	Aug	Sept	October	Nov	Dec
1991	254.4	260.8	268.6	279.9	293.4	296.1	294.0	291.5	289.4	288.3	288.8	285.1
1992	278.0	274.1	268.0	278.8	281.0	279.6	275.2	268.7	263.9	271.4	281.9	280.6
1993	275.2	265.3	264.7	278.5	280.5	277.3	271.0	261.1	253.6	249.9	255.6	270.2
1994	254.4	260.8	268.6	279.9	293.4	296.1	294.0	291.5	289.4	288.3	288.8	285.1
1995	253.8	260.3	262.5	275.3	289.0	288.7	284.5	282.2	288.2	283.8	279.9	287.5
1996	287.1	288.7	286.5	294.7	295.8	293.1	287.6	282.2	285.1	284.3	289.2	291.3
1997	289.4	284.5	281.7	285.2	294.1	292.0	287.0	280.0	272.9	272.4	270.8	277.2
1998	273.7	270.0	265.2	278.9	288.1	287.4	281.8	277.6	276.0	277.1	279.0	277.1
1999	272.7	275.6	281.5	290.5	295.9	293.3	288.3	279.5	271.0	257.6	263.6	276.9
2000	276.4	276.7	276.8	286.9	286.6	280.1	273.5	267.5	261.6	248.4	249.3	252.1
2001	253.6	258.2	275.1	282.9	287.6	283.8	273.7	271.1	269.2	263.6	263.2	252.1
2002	245.3	247.1	252.6	264.0	268.6	271.3	270.1	267.8	274.3	286.1	285.3	284.0
2003	291.1	289.5	286.3	287.0	292.3	290.3	285.9	280.8	276.0	282.6	285.6	283.3
2004	284.7	290.8	293.4	296.0	296.2	296.2	293.1	286.3	281.1	280.0	286.1	288.0
2005	281.2	281.5	293.3	296.1	295.6	294.1	286.7	277.2	266.5	256.9	253.6	279.0
2006	283.5	288.6	294.4	295.9	296.5	295.9	293.8	290.2	285.3	278.7	266.2	256.2
2007	256.1	263.7	272.0	276.8	276.8	274.8	268.5	263.6	261.8	261.1	275.8	282.1
2008	285.1	289.7	290.9	295.5	295.3	295.7	294.3	288.6	283.9	280.9	285.2	286.5
2009	283.6	281.8	283.4	292.5	293.7	292.4	288.0	281.2	276.2	271.6	266.3	280.1
2010	290.1	289.2	293.9	296.0	296.3	294.4	291.8	288.6	284.9	285.2	284.3	287.5
2011	281.6	274.4	275.0	276.6	281.0	286.1	284.7	279.0	273.9	268.2	261.6	264.5
2012	265.8	267.7	262.0	280.2	293.4	294.4	288.4	280.4	261.4	261.6	269.0	276.6
2013	278.3	281.5	294.8	296.9	296.9	294.2	289.7	283.6	280.8	281.4	282.5	276.1
2014	275.1	277.5	274.6	285.3	292.9	294.9	291.7	286.8	285.5	285.0	284.8	286.3
2015	288.7	289.4	292.2	296.3	296.1	293.3	287.5	280.1	272.1	275.4	278.9	275.9
2016	289.9	292.4	291.8	296.5	296.2	295.6	290.5	285.4	283.3	288.4	288.9	281.6
2017	271.5	277.7	280.9	278.7	281.6	272.4	270.2	268.0	271.0	264.6	269.6	289.9
2018	289.7	292.0	295.0	296.5	296.4	296.0	294.0	287.5	277.9	270.2	266.5	267.3
2019	267.3	268.2	272.7	279.9	289.9	292.7	287.6	278.5	274.2	268.6	273.2	275.6
2020	271.62	271.98	283.50	288.55	293.6	291.7	284.6	276.5	273.5	274.1	268.7	272.7
2021	291.70	294.10	292.60	294.30	296.7	291.7	282.7	274.3	271.3	267.7	267.8	275.1
2022	270.68	268.28	260.67	282.51	289.0	288.0	281.5	270.4	271.4	267.9	281.7	291.7

	Jan	Feb	March	April	May	June	July	August	Sept	Oct	Nov	Dec
2022	270.68	268.28	260.67	282.51	289.0	288.0	281.5	270.4	271.4	267.9	281.7	291.7
Average	275	277	280	286	291	290	285	279	275	273	275	278
Minimum	245.3	247.1	252.6	264.0	268.6	271.3	270.1	261.1	253.6	248.4	249.3	252.1
Maximum	291.7	294.1	294.4	296.9	296.9	296.2	294.3	291.5	289.4	288.3	289.2	288.0

Figure 13 Level of Fierza HPP for 1991 – 2022 period

(Source: KESH, TSO companies)

As follows it is graphically submitted the level of the water in Fierza reservoir for each month of 2022, compared to the historic monthly average levels for 1991– 2022 period.

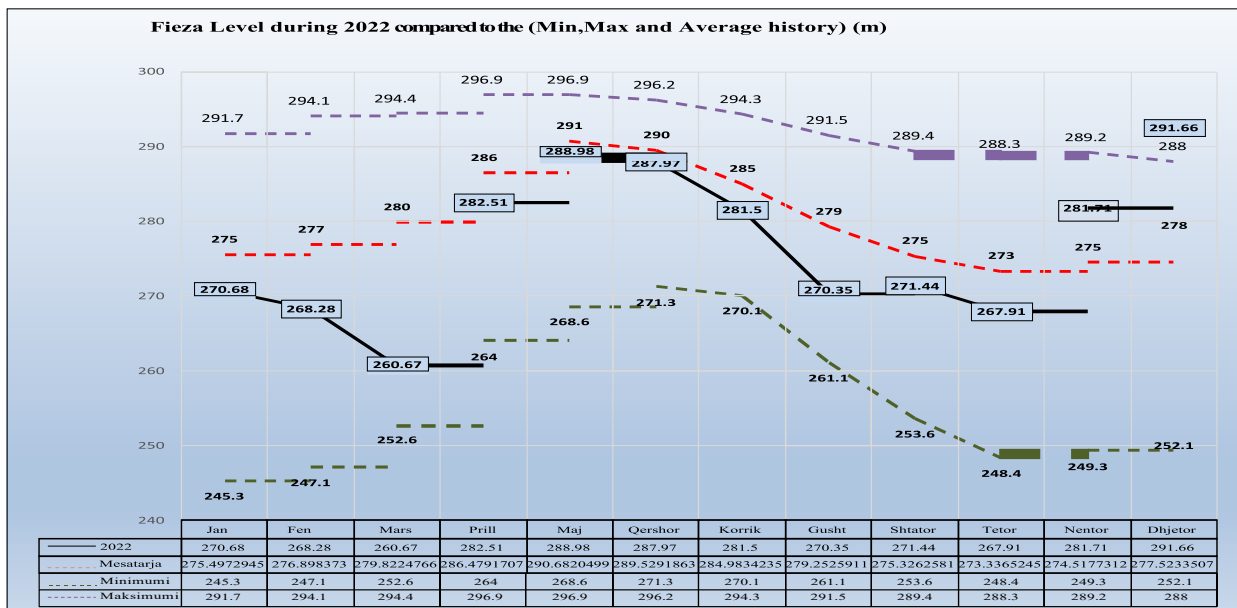

Figure 14 Fierza lake level (m) regarding to the average, minimum and maximum 1991 – 2022 period

As it can be seen until October 2022, the level of the water in Fierza lake has been under the historic average. As follows the level of the water in Fierza lake was significantly increased reaching 291.66 metër value, that is the maximum level of December for 2021-2022 period

The multiyear average of the level of the water in Fierza lake is the main indicator for planning the electricity production on Drini River cascade.

The figure below submits the average inflows of water for 2022 on Fierza lake compared to the average historical inflows for each month.

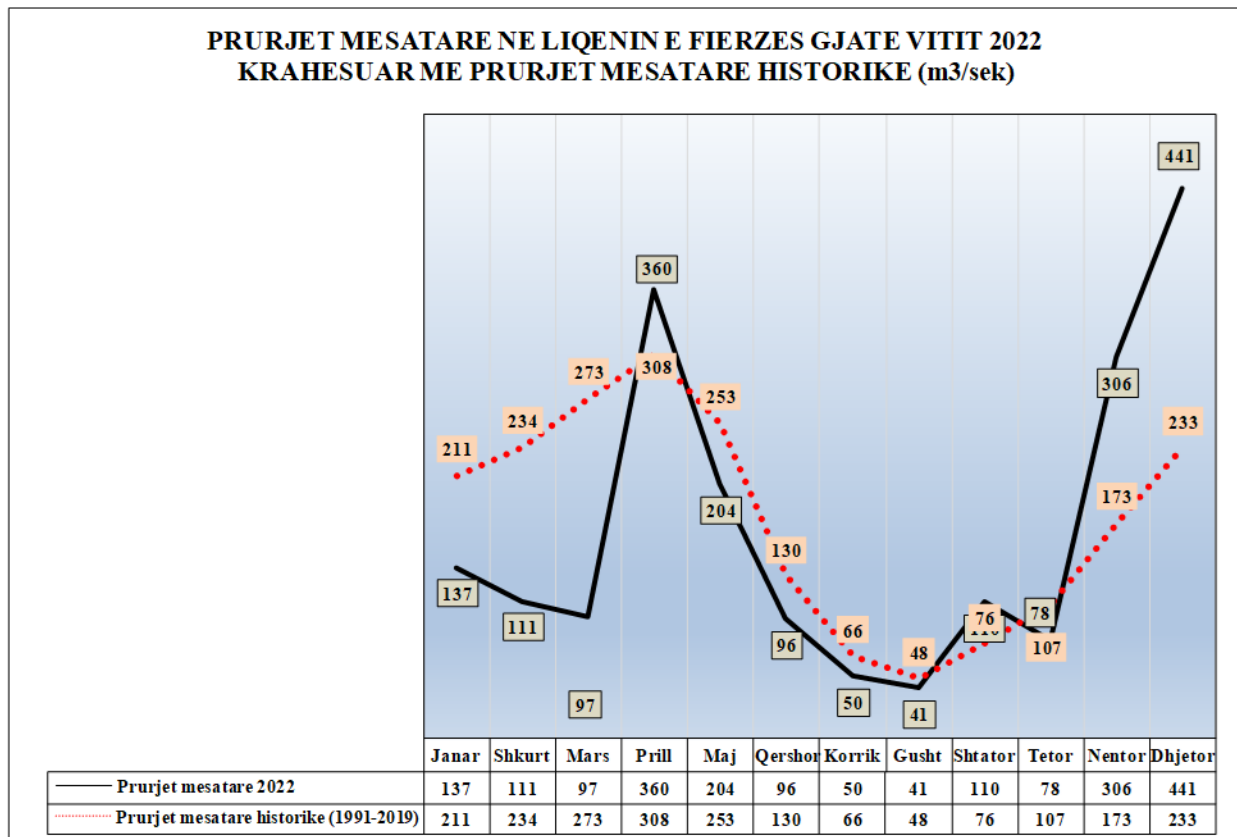

Figure 15 Average monthly inflows (m3/sec) in Fierza HPP during 2022 compared to the average history

During 2022 the average water inflows are in general low until on April where the historical average was overcome. For May – October period the flows resulted approximate to the historical average for November – December period were significantly increased.

On the following graph it is submitted the utilization of the power reserve on Drini river Cascade during 2022.

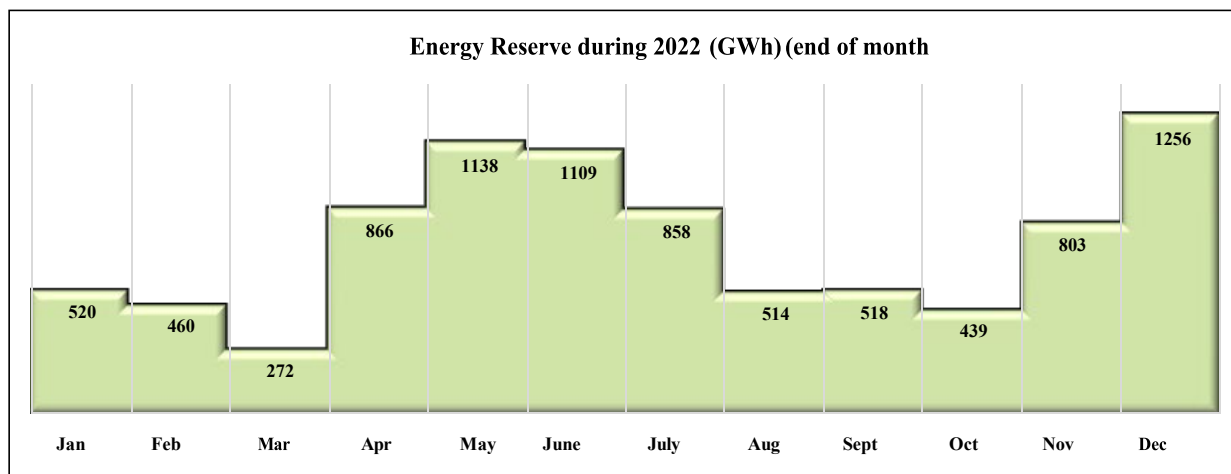

Figure 16 Daily Energy Reserve in Drini Cascade during 2022

(Source: KESH company)

The hydro power reserve of Drini river cascade shall be administered by KESH company based on the following criteria:

- Optimization of KESH company portfolio, and the sector in general.
- Operation in optimal level of the HPP and best utilization of the basins.
- Operation according to the definitions of the regulation for the dam safety.

Shall generate in a stable and qualitative way, guaranteeing the secure and low-cost electricity supply for the end-users.

Shall provide to the appropriate measure the ancillary services, to guarantee the safe and stable operation of the power system.

As evidenced even the energy reserve on the last of December 2022 resulted in maximum level of 1,256 GWh and at the end of March of that year this energy reserve reached 272 GWh, marking the lowest level of energy reserve during 2022.

1.2.3 Situation of Vlora TPP.

KESH company is the sole shareholder of Vlora Termo Power Plant (Vlora TPP), a company which manages the generating asset Vlora TPP.

Even during 2022, Vlora TPP has exercised its activity regarding the conservation of the generating asset which is not in working condition due to a defect in the cooling system since 2012.

1.2.3 Electricity generation from independent and priority, private generating plants.

Electricity generation realized by independent and priority generation plants for 2022 is 3,142,914 MWh or about 40% of the total domestic generation.

For 2022, the number of independent and priority generation plants that have produced electricity, is 240 where 9 of them are independent generators which are owned by 4 licensed entities, while the rest 231 plants are electricity priority producers, owned by 178 entities in the electricity generation activity. On this list are included Lanabregas HPP with installed capacity of 5MW and annual generation for 2022 of 25,423 MWh, whose shares as above mentioned are 100% owned by the state. In total, the installed capacity of independent and priority generation plants is 438 MW, where the installed capacity of independent generators is 438 MW, while 728 MW belongs to the generation and priority plants of electricity including Lanabregas HPP.

The data on the production groups are summarized as follows.

DATA ON PRODUCERS DURING		Network	No of Entities	No of the plants	Installed Capacity (MW)	Production 2022 (MWh)
P.Pub	Public Producers (Charged with public service obligation)	Connected to the DSO	1	4	1,448	3,859,731
P.Pav	Independent Producers (Producers in the Free Market)	Connected to the DSO	4	9	438	1,159,094
PPE	Priority Producers (Benefit from the Supporting Schemes) + Ashta	Connected to the DSO	33	48	380	1,130,403
	Priority Producers (Benefit from the Supporting Schemes)	Connected to the DSO	133	171	325	803,324
	Fotovoltaic Priority Producers (Benefit from the Supporting Schemes)	Connected to the DSO	12	12	23	50,093
			183	244	2,614	7,002,645

DATA ON INDEPENDENT AND PRIORITY PRODUCERS FOR 2022		Network	Number of Entities	Number of Plants	Installed Capacity (MW)	Production 2022 (MWh)
P.Pav	Independent Producers (Producers in the Open Market)	Connected to the TSO	4	9	438	1,159,094
PPE	Priority Producers (Benefit from the Supporting Schemes) + Ashta	Connected to the TSO	33	48	380	1,130,403
	Priority Producers (Benefit from the Supporting Schemes)	Connected to the DSO	133	171	325	803,324
	Fotovoltaic Priority Producers (Benefit from the Supporting Schemes)	Connected to the DSO	12	12	23	50,093
			182	240	1,166	3,142,914

Figure 17 Data on priority and independent producers for 2022

DATA ON INDEPENDENT PRODUCERS FOR 2022					
	HPP-s	MW	ENTITY	Connection	Production 2022
P.Pav	Hec "Ulez" me fuqi 25,2 MW	25.200	"Kurum International" sh.a.	110 kV	344,918
P.Pav	Hec "Shkopet" me fuqi 24 MW	24.000		110 kV	
P.Pav	Hec "Bistrica 1" me fuqi 22,5Mw	22.500		110 kV	
P.Pav	Hec "Bistrica 2" me fuqi 5 Mw	5.000		110 kV	
P.Pav	Hec "Peshqesh" me fuqi 27,94 MW;,,	27.940	"Ayen As Energji" sha	220 kV	91,389
P.Pav	Hec "Fangu" me fuqi 74.6 MW;,,	74.600		220 kV	230,338
P.Pav	Hec "Banje" me fuqi 73 MW	73.000	"Devoll Hydropower" sha	110 kV	167,931
P.Pav	Hec "Moglice" me fuqi 184 MW	184.000		110 kV	322,490
P.Pav	Hec Qami-1	1.730		"Lajthiza Invest "shpk	110 kV
		437.970			1,159,094

Figure 18 Data on independent producers for 2022

Data on Priority Producers for 2022		Network	Number of Entities	Number of Plants	Installed capacity (MW)	Production 2022 (MWh)
PPE	Priority Producers (Benefit from the Supporting Schemes)+Ashta	Connected to the TSO	33	48	380	1,130,403
	Priority producers (Benefit from the Supporting Schemes)	Connected to the DSO	133	171	325	803,324
	Priority Fotovoltaic producers (Benefit from the Supporting Schemes)	Connected to the DSO	12	12	23	50,093
			178	231	728	1,983,820

Figure 19 The data on priority producers for 2022

Production during 2022 from the Fotovoltaic Plants connected to Distribution Network (MWh)				
Fotovoltaic Plant	MW	Entity	Connecti on	2022 (10-M)
UKKO (pa sistemuarme sistem)	1	"UKKO"sha (Ujsjell.Kanal.Korce)		
Seman – 2	2	"SEMAN2SUN" sh.p.k	35 kV	4,179
Topojë	2	"SONNE" sh.p.k	35 kV	4,163
Topojë 2	2	"AED SOLAR" sh.p.k	35 kV	4,275
Topojë (Sheq Marinas)	2	"AGE SUNPOWER" sh.p.k	35 kV	4,156
Topojë (Sheq Marinas) 2	2	"SEMAN SUNPOWER" sh.p.k	35 kV	4,383
Seman1 solar	2	" SEMANISOLAR " sh.p.k	35 kV	4,127
ES 2019 sh.p,k	2	ES 2019 sh.p,k	35 kV	4,560
SMART WATT sh,p,k	2	SMART WATT sh,p,k	35 kV	4,539
Tren Bilisht	2	" RTS " sh.p.k	35 kV	3,899
STATKRAFT Renewbles albani PV Lundrues banje	2	"STATKRAFT"	35 kV	503
Pv -Plug	2	"AEE" sh.p.k	10 kv	4,515
"Plant of Urban Waste Management in Elbasan Area "			35 kV	6,792
23				50,092

Figure 20 Fotovoltaic plants and the waste management for 2022

1.2.4 Production from the plants introduced into generation during 2022

The annual net production of electricity from plants that are introduced in generation during 2022 is submitted on Figure no.21, as follows. As it can be seen during 2022, are introduced into production 6 plants with an installed capacity of 9.43 MW, which during 2022 generated the quantity of about 14.079 MWh. The electricity production realized from the plants introduced into production during 2022 occupies about 0.2 % of the total domestic generation of electricity for this year.

Production and Capacity of the HPP-s introduced in production during 2022 from the Plannts connected to the Transmission Network (MWh)																
HPP	MW	Entity	Conn	JAN	Feb	March	April	May	June	June	Aug	Sept	Oct	Nov	Dec	2022
Hec Qami-1	1.730	"Lajthiza Invest "shpk				34	750	72	0	0	0	98	90	363	622	2,029
Production and Capacity of the HPP-s introduced in production during 2022 from the Plants connected to the Distribution Network (MWh)																
HPPs and Capacity I	MW	Entity	Connectio n	JAN	Feb	March	April	May	June	Julz	Aug	Sept	Oct	Nov	December	2022
Hec Drita	1.98	"Brecani R.O.S.P." shpk	20		720	568	1,039	1,446	837	172	51	281	434	548	1,206	7,301
Hec Terfori	1.98	"HEC TERFOJA" sh.p.k					199	452	500	219	101	219	257	321	826	3,093
Hec EME	0.45	"EME" shpk											16	87	251	354
Hec Borie Lura 1	1.8	"AGETA" sh.p.k													246	246
Hec Mali	1.49	"TIRANA ENERGIJ" sh.p.k													1,056	1,056
	7.7															12,050
	9.43															14,079
	MW															MWh

Figure 21 Production from the Plants introduced to production during 2022

1.2.5 Electricity production according to the network where are connected the production plants

The installed capacity of the plants connected to the transmission network during 2022 is 2,266 MW. The total electricity production from the plants that are connected to these plants is 6,149,229 MWh. The detailed production for each of the plants connected to the transmission network during 2022 is submitted on the table as follows:

Production during 2022 from the Plants Connected to the Transmission Network (MWh)				
HPP-S AND CAPACITY	MW	ENTITY	Connection	2022
Hec "Fierze" me fuqi 500 MW	500.000		220 kV	3,859,731
Hec "Koman" me fuqi 600 MW	600.000	"KESH" sha	220 kV	
Hec "V. Dejes" me fuqi 250 MW	250.000		220 kV	
Tec Vlora me fuqi 98 MW	98.000	"KESH" sha	220 kV	
				3,859,731

Hec "Ulez" me fuqi 25,2 MW	25.200		110 kV	
Hec "Shkopet" me fuqi 24 MW	24.000	"Kurum International" sh.a.	110 kV	344,918
Hec "Bistrica 1" me fuqi 22,5Mw	22.500		110 kV	
Hec "Bistrica 2" me fuqi 5 Mw	5.000		110 kV	
Hec"Peshqesh"me fuqi 27,94 MW,;	27.940	"Ayen As Energji"sha	220 kV	91,389
Hec"Fangu"me fuqi 74.6 MW,;	74.600		220 kV	230,338
Hec "Banje" me fuqi 73 MW	73.000	"Devoll Hydropower" sha	110 kV	167,931
Hec "Moglice" me fuqi 184 MW	184.000	"Devoll Hydropower" sha	111 kV	322,490
Hec Qami-1	1.730	"Lajthiza Invest "shpk		2,029
				1,159,094
Hec "Ashta" me fuqi 48,2 MW	48.200	"Energji Ashta" shpk	110 kV	236,275
				236,275
Hec "Bishnica 2" me fuqi 2.5 MW	2.500	"HEC Bishnica 1,2 "shpk	110 kV	9,307
Hec "Dardhe" me fuqi 5,8 MW	5.800	"Wenerg " shpk	110 kV	
Hec"Truen" me fuqi 2,5 MW	2.500	"TRUEN" shpk	110 kV	16,391
Hec"Terrove" me fuqi 8.385 Mw	0.921	"TEODORI 2003" shpk	110 kV	8,020
Hec"Gjorice" me fuqi 4,18 Mw (+h/c ne prodhim)	29.610	"DITEKO" shpk	110 kV	100,767
Hec"Sllabinje" me fuqi 13,8 MW	13.800	"Power Elektrik Slabinje" shpk	110 kV	63,539
Hec"Bele 1"me fuqi 5 MW ;	5.000	"Euron Energy" shpk		
Hec"Topojan 2" me fuqi 5,8 MW,	5.800			
Hec"Bele 2"me fuqi 11 MW ;	11.000		110 kV	116,771
Hec"Topojan 1" me fuqi 2,9 MW,	2.900	"Alb-Energy" shpk		
Hec"Orgjost I Ri" me fuqi 4,8 MW	4.800	"Energal" shpk		
Hec "Cerunje-1" me fuqi 2.3 MW;	2.300	"Energy partners Al" shpk		
Hec "Cerunje-2" me fuqi 2.8 MW;	2.800		110 kV	15,845
Hec "Rrupe" me fuqi 3.6 MW;	3.600			
Hec "Rapuni 1,2" me fuqi 4 dhe 4.1 MW	8.100	"C & S Construction Energy" shpk	110 kV	29,334
Hec "Rapuni 3,4" me fuqi 8.857 MW	8.850	"C & S Energy" shpk	110 kV	24,571
Hec"Llapaj" me fuqi 13,62 MW	13.620	"Gjo.Spa.POWER"shpk	110 kV	39,141
Hec"Lengarice" me fuqi 8.94 MW	8.940	"Lengarica & Energy" shpk	110 kV	22,394
Hec"Lura 1" me fuqi 6,54 MW	6.540		110 kV	
Hec"Lura 2" me fuqi 4,02 MW	4.020	"Erdat Lura" shpk	110 kV	36,967
Hec"Lura 3" me fuqi 5,66 MW	5.660		110 kV	
Hec"Malla" me fuqi 5,455 MW	5.455	"Gjure Rec" shpk	110 kV	11,966
Hec Prella me fuqi 14.97 MW	14.970	"Prelle Energji"	110 kV	35,095
HEC Cemerica 1	0.88		110 kV	
HEC Cemerica 2	1.08	"REJ ENERGY" shpk	110 kV	12,833
HEC Cemerica 3	2.1		110 kV	
HEC TUÇ	4.47		110 kV	
HEC Lumzi	11	MC Inerte Lumzi	110 kV	28,654
Hec Denas	14.5	"Denas Power" shpk	110 kV	32,668
Llënga 1	1.73		110 kV	
Llënga 2	0.3	"HEC LLËNGË" sh.p.k	110 kV	8,205
Llënga 3	1.5		110 kV	
HEC Shpella Poshte	2.3	Liria Energji shpk	110 kV	9,043
HEC Germani 1	4.8		110 kV	
HEC Germani 2	1.5	SA'GA-MAT shpk	110 kV	10,841
Hec Lashkiza 1	4.076		110 kV	
Hec Lashkiza 2	0.882	HEC Lashkiza shpk	110 kV	5,191
Hec Seta 1+2	7.454		110 kV	
Hec Seta 3	2.722	"Hydro Seta" sh.p.k	110 kV	33,147
Hec Seta 4	4.724		110 kV	
HEC Darsi 1,2,3	12.7	Henz Energy shpk	110 kV	26,038
HEC Egnatia	5.1	REMI shpk	110 kV	12,066
HEC Seka & Zais/684	14.96	SEKA Hydropower shpk	110 kV	61,636
HEC ARSTI	3.13	Hec Arsti shpk	110 kV	12,934
HEC KASKADA GJADER T1/344	24.9	S.P.E. Gjader shpk	110 kV	21,892
HEC-et Dragobia&Ceremi/686	21.9	Dragobia Energy shpk	110 kV	68,542
HEC Veleshica 1,2	13.9	"Kalisi Hydropower"shpk	110 kV	20,329
	2,266			894,128

Figure 22 Production from the plants connected to transmission network for 2022

(Source: FTL, TSO companies)

Production during 2022		CENTRALET E LIDHURA NE RRJETIN E SHPERNDARJES (MWh)		
HPP-S AND CAPACITIES	MW	ENTITY	Connection	2022
Hec "Lanabregas" me fuqi 5 MW	5.000	"Hec Lanabregas" sha	35	25,423
Hec "Lenie" me fuqi 400 kW	0.400		10kV	2,281
Hec "Çorovode" me fuqi 200 kW	0.200	"EMIKEL 2003" sh.p.k	10kV	557
Hec "Smokthine" me fuqi 9,2 MW	9.200	"Albania Green Energy" sh.p.k	35 kV	30,408
Hec "Bulqize" me fuqi 0,6 MW (Diber)	0.600		10kV	1,260
Hec "Homesh" me fuqi 0,395 MW (Diber)	0.395		10kV	317
Hec "Zerqan" me fuqi 0,625 MW (Diber)	0.625		6kV	1,098
Hec "Arras" me fuqi 4,8 MW (Diber)	4.800		20kV	14,296
Hec "Orgjost" me fuqi 1,2 MW (Kukes)	1.200		10kV	5,188
Hec "Lekbibaj" me fuqi 1,4 MW (Tropoje)	1.400		10kV	6,640
Hec "Dukagjin" me fuqi 0,64 MW (Shkoder)	0.640		10kV	2,111
Hec "Marjan" me fuqi 0,2 MW (Korce)	0.200		10kV	-
Hec "Lozhan" me fuqi 0,1 MW (Korce)	0.100		10kV	320
Hec "Barmash" me fuqi 0,83 MW (Kolonje)	0.830		10kV	1,161
Hec "Treske 2" me fuqi 0,25 MW (Korce)	0.250		10kV	621
Hec "Nikolice" me fuqi 0,7 MW (Korce)	0.700	"Balkan Green Energy" shpk	10kV	1,410
Hec "Funares" me fuqi 1,92 MW (Librazhd)	1.920		10kV	5,891
Hec "Lunik" me fuqi 0,2 MW (Librazhd)	0.200		10kV	829
Hec "Kerpice" me fuqi 0,42 MW (Gramsh)	0.420		6kV	702
Hec "Ujanik" me fuqi 0,63 MW (Skrapar)	0.630		10kV	1,120
Hec "Borsh" me fuqi 0,25 MW (Sarande)	0.250		6kV	745
Hec "Leshnice" me fuqi 0,38 MW (Sarande)	0.380		10/6kV	479
Hec "Velcan" me fuqi 1,2 MW (Korce)	1.200		10kV	3,138
Hec "Muhur" me fuqi 0,25 MW (Diber)	0.250		6kV	652
Hec "Rajan" me fuqi 1,02 MW (Kolonje)	1.020		10kV	2,214
Hec "Lure" me fuqi 0,75 MW (Diber)	0.750		10kV	334
Hec "Gjanç " me fuqi 2,96 MW	2.960	"Spahiu Gjanç" sh.p.k.	35 kV	7,562
Hec "Bogove" me fuqi 2,5 MW	2.500	"Wonder power" sha	35 kV	5,540
Hec "Xhyre" me fuqi 570 kW	0.570	"Amal" sh.p.k	10kV	1,775
Hec "Stranik" me fuqi 4,6 MW	4.600		35kV	11,055
Hec "Zall Tore" me fuqi 3 MW	3.000	"Hidroinvest 1" shpk	35kV	10,164
Hec "Klos" me fuqi 1,95 MW	1.950	"Malido-Energji" shpk	6kV	2,785
Hec "Borje" me fuqi 1,5 MW	1.500	"HIDROALBANIA Energji" shpk	35kV	17,809
Hec "Cernaleve " me fuqi 2,95 MW	2.950	"HIDROALBANIA Energji" shpk	35kV	7,930
Hec "Cernaleve 1" me fuqi 3,27 MW	3.270	"HIDROALBANIA Energji" shpk	35kV	8,753
Hec "Murdhar 1" me fuqi 2,68 MW	2.680		10kV	8,733
Hec "Murdhar 2" me fuqi 1 MW	1.000	"HydroEnergy "shpk	10kV	4,980
Hec "Dishnice" me fuqi 0,2 MW	0.200	"Dishnica Energy" shpk	10kV	473
hec "Lubonje" me fuqi 0,3 Mw	0.300	"Elektro Lubonje" shpk	10kV	467
Hec "Peshke" me fuqi 3,43 MW	3.430	"Koka & Ergi Energy Peshk" shpk	35kV	9,723
Hec "Labinot –Mal" me fuqi 0,25 MW	0.250	"Ansara Koncension" shpk	6kV	248
Hec "Pobreg" me fuqi 12,3 MW	12.300	"Energy Plus" shpk	35kV	38,242
Hec "Vlushe" me fuqi 14,2 MW	14.200	"Hec Vlushe " shpk	35kV	32,644
Hec "Belesova 1" me fuqi 0,150 MW	0.150	"Korkis 2009" shpk	6kV	125
Hec "Faqekuq 1,2" me fuqi (3 MW; 3,4 MW)	6.400	"HP OSTROVICA" shpk	35kV	15,047
Hec "Shemri" me fuqi 1 MW	1.000		10	2,793
Hec "Mgulle" me fuqi 0,28 MW	0.280	"Erald Energjitik" shpk	10kV	1,664
Hec "Kryezi 1" me fuqi 0,6 Mw	0.600	"Bekim Energjitik" shpk	10kV	3,076
Hec "Selishte" me fuqi 2 MW	2.000	"Selishte" shpk	35kV	4,863
Hec "Carshove" me fuqi 1,5 Mw	1.500		10kV	2,499
Hec "Ura e Dashit" me fuqi 1,2MW	1.200	"ERMA MP" shpk	10kV	7,805
Hec "Gizavesh" me fuqi 0,5 MW	0.500	"Dosku Energy" shpk	10kV	2,815
Hec "Koka 1" me fuqi 3,2 MW	3.200	"Snow Energy" shpk	35kV	5,392
Hec "Stravaj" me fuqi 3,6 MW	3.600	"Stravaj Energji" shpk	35kV	10,670
Hec "Picar 1" me fuqi 0,2 MW	0.200	"Peshku Picar 1" shpk	6kV	412
Hec "Vertop" me fuqi 1,52 Mw	1.520	"Hydro Salillari Energy "shpk	35kV	1,568
Hec "Martanesh" me fuqi 10,5 MW	10.500	"Albanian Power" shpk	35kV	15,694
Hec "Verba 1,2" me fuqi (2 MW, 3 MW)	5.000	"Hydro power Plant Of Korca" shpk	35kV	8,112
Hec "Fterra" me fuqi 1,08 MW	1.080	"Hidro Borshi" shpk	35kV	7,659
Hec "Ostren i Vogel" me fuqi 0,32 MW	0.320	"Lu & Co Eco Energy" shpk	10kV	866
Hec "Kozel" me fuqi 0,5 MW	0.500		10kV	732
Hec "Helmes 1" me fuqi 0,8 MW	0.800	"E.T.H.H. "shpk	10kV	1,755
Hec "Helmes 2" me fuqi 0,5, MW	0.500		10kV	907
Hec "Qafezeze" me fuqi 0,4 MW	0.400	"Caushi Energji" shpk	10kV	2,991
Hec "Trebisht" me fuqi 1,775 MW	1.775	"SA.GLE.Kompani "shpk	10kV	3,258
Hec "Mollaj" me fuqi 0,6 MW	0.600	"Energji Xhaci" shpk	10kV	582
Hec "Tucep" me fuqi 0,4 MW	0.400	"Tucep" shpk	10kV	2,797
Hec "Treska4" me fuqi 3,6 MW	3.600		35kV	8,282
Hec "Treska3" me fuqi 0,3 MW	0.300	"Hec-Treske"shpk	35kV	1,165
Hec "Treska 2T" 5 me fuqi 0,62 MW	0.620		35kV	2,083
Hec "Sotire1 & 2" me fuqi 2,2 MW	2.200	"Hidro Energy Sotire"shpk	35kV	4,716
Hec "Shutine" me fuqi 2,4 MW	2.400	"Shutina energji"shpk	10kV	2,999
Hec "Cekrez 1,2" me fuqi (0,23 MW; 0,43 MW)	0.660	"Zall Herr Energji 2011"shpk	6kV	3,785
Hec "Qarr" me fuqi 1 MW	1.000	"Hec Qarr & Kaltani"shpk	35kV	4,065
Hec "Bisak" me fuqi 1,3 MW	1.300	"Bardhgjana" shpk	6kV	3,488
Hec "Shales" me fuqi 1,08 MW	1.080		35kV	32
Hec "Strelce" me fuqi 1,174 MW	1.174	"Gjoka Konstruksion Energji" shpk	35kV	4,283
Hec "Shpelle" me fuqi 400 kW	0.400	"Sarolli" sh.p.k	10kV	1,135
Hec "Bicaj" me fuqi 3,1 MW	3.100	"EN-KU" sh.p.k	10kV	-

Hec "Leskovik 1" me fuqi 1072 kW	1.072	"Maksi Elektrik" sh.p.k	10kV	354
Hec "Leskovik 2" me fuqi 1100 kW	1.100		10kV	441
Hec "Orenjë" me fuqi 875 kW	0.875	"Juana" sh.p.k	10kV	899
Hec "Tamarë" me fuqi 750 kW	0.750	"WTS Energji" shpk	10kV	-
Hec "Benë" me fuqi 1000 kW	1.000	"Marjakaj" shpk	6kV	1,241
Hec "Vithkuq" me fuqi 2,715 MW	2.715	"Favina 1" shpk	35/10kV	9,253
Hec "Selce" me fuqi 1600 kW	1.600	"Selca Energji" shpk	10kV	4,756
Hec "Kumbull- Merkurth" me fuqi 0.83 Mw	0.830	"DN & NAT Energy" shpk	6kV	1,887
Hec "Sasaj" me fuqi 8,6 MW	8.600	"Energo - Sas" shpk	35kV	19,855
Hec "Tervol" me fuqi 10.6 MW	10.600	"Hec i Tervolit" shpk	35kV	25,742
Hec "Radove" me fuqi 2,5 MW	2.500	"MTC Energy" shpk	10kV	7,346
Hec "Gurshpat 1" me fuqi 0,84 MW,	0.840		10kV	3,103
Hec "Gurshpat 2" me fuqi 0,83 MW	0.830	"Gurshpat Energy" shpk	10kV	3,444
Hec "Bistrica 3" me fuqi 1,57 MW,	1.570	"Bistrica 3 Energy" shpk	6kV	8,468
Hec "Hurdhas 1" me fuqi 1,71 MW,	1.710	"Komp Energji" shpk	6kV	10,186
Hec "Perrollaj" me fuqi 0,5 MW	0.500	"Fatlum" shpk	10kV	815
Hec "Koxheraj" me fuqi 0,62 MW	0.620	"Koxherri Energji" shpk	10kV	1,337
Hec "Kacni" me fuqi 3,87 MW	3.870	"Kis i-Bio-Energji" shpk	20kV	5,862
Hec "Lena 1" me fuqi 1,95 MW,;	1.950		35kV	
Hec "Lena 2" me fuqi 2,3 MW	2.300	"Gama Energy" shpk	35kV	5,662
Hec "Lena 2A" me fuqi 0,25 MW	0.250		35kV	
Hec "Driza" me fuqi 3,408 MW	3.408	"Mesopotam Energy" shpk	35kV	2,312
Hec Strelca 1,2,3 (1.504 MW, 0.325 MW, 3.52 MW)	5.349	"Strelca Energy" shpk	35kV	12,554
Hec "Ujanik 2" me fuqi 2,5 MW	2.500	"HP Ujaniku Energy" shpk	35kV	3,928
Hec "Nishove" me fuqi 1,36 MW	1.360	"Nishova Energy" shpk	35kV	356
Hec "Shtika" me fuqi 1,3 MW	1.300	"Perparimi SK" shpk	10kV	2,049
Hec "Ballenje" me fuqi 1,9 MW	1.900	"Ballenja Power Martanesh" shpk	35kV	2,713
Hec Gavran 1	0.998	"Gavran Energy" shpk	35kV	2,294
Hec Gavran 2	1.215	"Gavran Energy" shpk	35kV	1,896
Hec Kasollet e Selces 1	4.000	"Xhango Energji" shpk	35kV	8,995
Hec Holta Kabash	2.200	HEC Kabash Porocan shpk	35kV	9,610
Hec Holta Poroçan	3.300		35kV	
Hec Lusen 1	0.315	"Eurobiznes" shpk	35kV	491
Hec Ura e Fanit	1.000	"Aycn As Energji" sha	35kV	5,742
HEC Gorice	1.747	"THE BLUE STAR" sh.p.k	35kV	4,123
HEC Kabash 1&2	5.800	"Univers Energji" shpk	35kV	5,690
HEC "Tucep 2"	1.7	"DUKA T2" shpk	35kV	3,146
Hec Dobrenje Tomorrice	2.4	DAAB Energy Group shpk	35kV	3,084
Hec Razdoll	0.765	Hidro Vizion shpk (I pa licens nga ERE)	35kV	1,648
Hec Dragostunje	3.1	"HEC-i Dragostunje" shpk	35kV	15,738
Hec Stebleve	3.4	"PURE ENERGY STEBLEVA" shpk	35kV	2,232
Hec Zerec 1	0.55			
Hec Zerec 2	1.315	"EnRel Hydro" shpk	35kV	4,431
Hec Shëngjon 1	0.651			
Hec Shëngjon 2	0.356	"EDIANI" sh.p.k.	35kV	2,021
HEC Blaç	1.3	"BLAC ENERGY" sh.p.k	35kV	496
HEC Qarrishtë	0.3	"IDI-2005" SHPK	35kV	949
HEC Vendresh	0.456	"HP VENDRESH ENERGY" SHPK	35kV	245
HEC "Antena"	1.105	"DERBI-E" shpk	35kV	2,190
HEC "Kamenicë"	0.973	HP Kamenica shpk	10	2,539
HEC "Qytezë"	0.9	Muso hec Qytezë	10	1,936
HEC Marjan Gura e Vesheve	0.63	Marituda Shpk	10	1,455
HEC Skatinë	2.677	Skatina Hec Shpk	10	4,784
HEC Kaparjel	0.2	ABV Konstruksion Shpk	10	434
HEC Letaj	0.54	Asi-Tre Shpk	10	756
HEC Nice	2.133	MP-HEC Shpk	35	1,862
HEC Meshurdhe	1.8	SIMA-Com Shpk	10	6,404
HEC Thanez	1.95	AFRIMI K Shpk	35	6,496
HEC OSOJE	1.9	OSOJA HPP shpk	35	8,295
Hec Voskopoje	1.9	FAVINA 1 shpk	35	5,848
Hec Nderfushas	1.34	SGD Energji shpk	35	1,477
Hec Rreshen	0.38	Nikolli Energji shpk	10	1,098
Hec Gurra	0.5	Uleza Ndertim shpk	6	1,047
Hec Vile	1.994	Hydro Power Panariti shpk	35	4,970
Hec Dukona	0.800	Dukona shpk	20	494
Hec Prevalli	1.750	Gega-G shpk	35	5,721
HEC Camerice	0.800	Rei Energji shpk	35	4,553
Hec Stror	2.000	Era Hydro shpk	35	8,802
Hec Mivas	1.940	Elva 2001 shpk	35	3,885
Hec Spathare	1.038	Lucente concensionare shpk	10	3,340
Hec Miraka	0.600	Kuarci Blace shpk	10	758
Hec Shegjun	2.000	Irarba Energji shpk	10	1,762
hec Dobrunje	0.840	W.T.S. Energji shpk	10	2,439
Hec Muras	2	Mateo& Co shpk	10	7,384
Hec Trojet	0.9	Trojet Energji shpl	10	1,984
Hec Deni	0.85	ASI TRE shpk	35	1,443
Hec Kamican	1.86	IGI 2005 shpk	35	5,545
Hec Vardar	1.97	Gerti shpk	35	7,134
Hec Stavec	6.5	Koka Ergi Stavec shpk	35	24,509
Hec Kallis	2.13	ERDY Energy shpk	35	6,702
Hec Gjinar	0.83	Erdi Gas shpk	10	1,052
Hec Backa 1	3.36	Kroi Mbret shpk	35	10,436
Hec Plepi	2.28	Domi Tee shpk	35	1,445
Hec Zall Xhuxhe	4.7	Hec Zall Xhuxhe	35	7,060
Hec Pisha	1.9	Green TECH energy systems	35	1,139
Hec Lingjanca 1&2	2.2	"Rei-Energji" shpk	35	4,686
Hec Guri i Zi	1.7	"Aris Albania" shpk	35	1,818
Hec Drita	1.98	"Brecani R.O.S.P." shpk	20	7,301
Hec EME	0.45	"Hec EME" shpk		354
Hec Terfori	1.98	"HEC TERFOJA" sh.p.k		3,093
Hec Borie Lura 1	1.8	"AGETA" sh.p.k		246
Hec Mali	1.49	"TIRANA ENERGI" sh.p.k		1,056
	325			803,322

PRODUCTION DURING 2022 FROM FOTVOLTAIC PLANTS CONNECTED TO THE DISTRIBUTION NETWORK					(M	Vh)
Fotovoltaic Plant	MW	Entity	Connection	2022 (10-M)		
UKKO (pa sistemuarne sistem)	1	"UKKO"sha (Ujrsjell.Kanal.Korce)				
Seman – 2	2	"SEMAN2SUN" sh.p.k	35 kV			4,179
Topojë	2	"SONNE" sh.p.k	35 kV			4,163
Topojë 2	2	"AED SOLAR" sh.p.k	35 kV			4,275
Topojë (Sheq Marinas)	2	"AGE SUNPOWER" sh.p.k	35 kV			4,156
Topojë (Sheq Marinas) 2	2	"SEMAN SUNPOWER" sh.p.k	35 kV			4,383
Seman1solar	2	"SEMAN1SOLAR " sh.p.k	35 kV			4,127
ES 2019 sh.p.k	2	ES 2019 sh.p.k	35 kV			4,560
SMART WATT sh,p,k	2	SMART WATT sh,p,k	35 kV			4,539
Tren Bilisht	2	" RTS " sh.p.k	35 kV			3,899
STATKRAFT Renewbles albani PV Lundrues banje	2	"STATKRAFT"	35 kV			503
Pv -Plug	2	"AEE" sh.p.k	10 kv			4,515
"Plant for Urban Wastes Management in Elbasan Area"			35 kV			6,792
						23
						50,092

Figure 23 Production from the plants connected to the distribution system during 2022

(Source: TSO company; OSHEE company; FTL company)

The installed capacity of the power plants connected to the distribution network is 348 MW. This installed capacity of the plants in the distribution network consists of 325 MW of the installed capacity at Hydro resources and 23 MW installed capacity in photovoltaic plants. The production realized by the hydropower plants connected to the distribution network during 2022 is on 803,322 MWh quantity, while the production realized by the photovoltaic plants is on 50,092 MWh quantity.

1.3 ELECTRICITY TRANSMISSION

Electricity transmission in Albania is performed through the high voltage network of 400 kV, 220 kV, 150 kV, and 110 kV

Law no. 43/2015 "On Power Sector", as amended stipulates that: "Transmission System" is the system used for the transmission of electricity at high and very high voltage, parallelly connected with the systems of other countries, which includes, but is not limited to, lines, supporting structures, transformer and switching equipment for the delivery of Electricity to customers or in the distribution network, excluding supply.

1.3.1 Power balance

The following table submits the electricity balance of TSO company for 2022 compared to the 2015 – 2022 period.

No.	Power Balance of TSO company (GWh)	2015	2016	2017	2018	2019	2020	2021	2022
I	Total Energy to the Transmission System	7,830	8,462	7,577	9,848	7,943	8,130	10,685	9,547
1	- Domestic Production	5,475	6,636	4,174	8,076	4,767	4,892	8,432	6,504
2	- Intake Energy (imports to interconnection)	2,355	1,827	3,403	1,772	3,177	3,238	2,253	3,044
II	Total Transmitted Energy	7,672	8,272	7,419	9,606	7,775	7,958	10,685	9,547
1	- Offtake Energy (exports to interconnection)	956	1,869	488	2,685	770	963	2,800	2,123
2	- Transmitted Energy for DSO company	6,106	5,901	6,148	5,963	6,137	6,184	6,606	6,546
3	- Transmitted Energy for the customers connected to the transmission system	610	503	781	957	867	811	1,049	679
III	Losses to the Transmission System + Personal Needs	159	190	158	242	169	172	228	200
	Losses to the Transmission System +Personal Needs (%)	2.03	2.25	2.08	2.46	2.12	2.12	2.13	2.09

Figure 24 Power Balance of TSO company for 2022 compared to the one of 2015 - 2022 period (MWh)

The level of Losses in the transmission system for 2022 is 199,994 MWh or 2.09 % of the transmitted electricity. This level of losses in the Transmission System for 2022 results with a slight decrease compared with the one of 2020 and 2021 period. The level of the losses in the Transmission System is connected with the transmitted electricity quantity as well as the level with the generation level of the HPP-s connected in Transmission System.

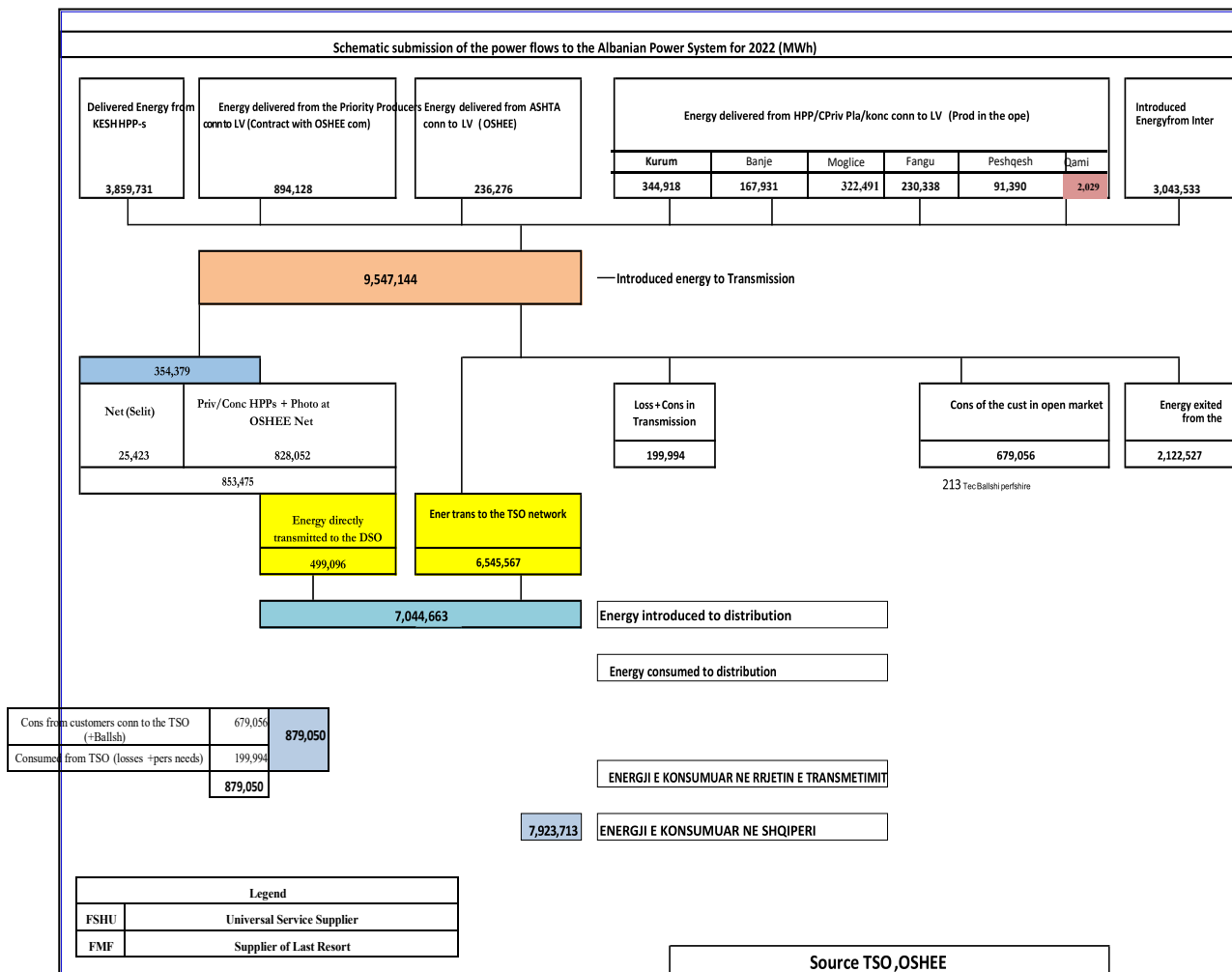

Figure 25 Schematic submission of the electricity flows to the Albanian Power System for 2022

The schematic submission of the energy flows to the Albanian Power System is submitted on details at the above figure. The total energy quantity injected to the transmission system for 2022 is about 9,547 GWh. The total electricity quantity injected to the distribution system is about 7,045 GWh.

The electricity to the distribution system is injected from the transmission system and from the generation plants connected to the distribution network. The transmission system injected for 2022 to the distribution system the total quantity of about 6,546 GWh, while the generation plants connected to distribution network injected to this network the net quantity of electricity of about 499.1 GWh.

1.3.2 TSO company activity

The Transmission System Operator is a legal entity licensed to perform the activity of electricity transmission, which owns the transmission system based on the definitions of Article 54 of Law no. 43/2015 "On Power Sector", as amended. In our country the Transmission System Operator (TSO) is a public company with 100% of state shares, established on 14 July 2004.

The Transmission System Operator exercises its activity unbundled from other activities in the Power sector, such as production, distribution, trade and supply of electricity, in accordance with the principles and requirements set out in law.

TSO company during 2022 performed the operations of the Transmission Network Operator, the Market Operator as well as the Dispatch System Operator. At the same time ERE Board approved decision no. 247, dated 29.09.2022 by licensing the Albanian Power Exchange – ALPEX company in electricity market operation activity.

TSO guarantees the necessary capacities for the transmission of:

- Uninterrupted electricity supply of electricity distribution system substations, as well as electricity customers connected directly in the transmission network,
- Electricity transmission produced from the country's resources;
- Necessary transition and exchange with the regional countries.

In this context TSO company develops the Transmission System in accordance with the long-term requirements of the country's electricity supply, with development plans for new resources of electricity and coordinates the development of the interconnection network with neighboring countries. TSO company dispatches the Albanian Electricity system through the management of energy flows in the system, considering the implementation of all ancillary services related to the stability of the system and exchanges with other neighboring systems.

1.3.2.1 Assets and Development of the Transmission System

The Electricity Transmission System of Albania includes all the voltage lines of 400 kV, 220 kV, 150 kV, 110 kV and the connection substations between them that serve for the electricity transmission and interconnection.

The line of the transmission system length according to the voltage level are:

400 kV transmission line	445.7 km
220 kV transmission line	1,250 km
150 kV transmission line	34.4 km
110 kV transmission line	1624 .162 km

The above mentioned are part of the Transmission system and the interconnection lines with neighbouring countries like:

400 kV Zemblak (Albania) – Kardia (Greece) interconnection line

400 kV Tiranë (Albania) – Podgoricë (Monte Negro) interconnection line

400 kV Tiranë (Albania) – Prishtinë (Kosovo) interconnection line

220 kV Fierzë (Albania) – Prizren (Kosovo) interconnection line

220 kV Koplík (Albania) – Podgoricë (Monte Negro) interconnection line

150 kV Bistricë (Albania) – Myrtos (Greece) interconnection line

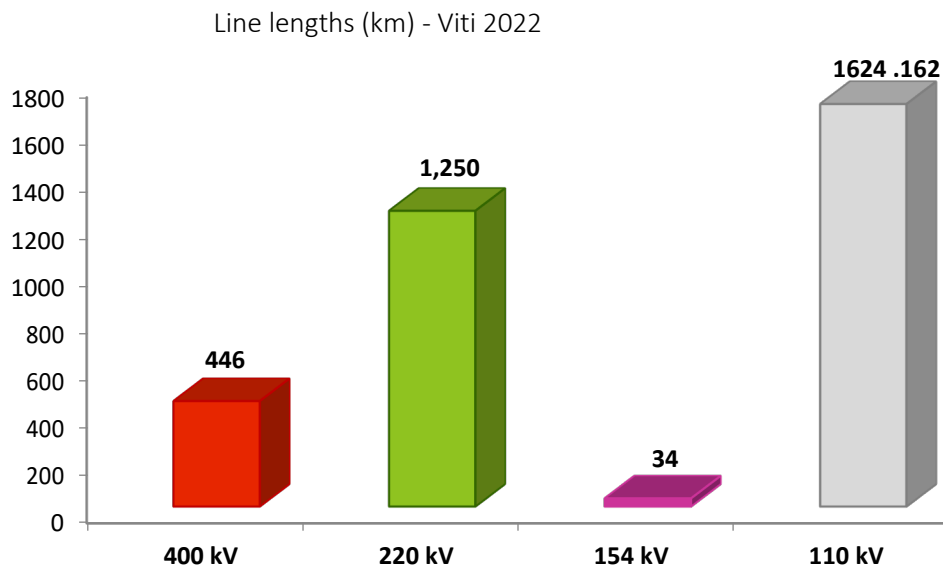

Figure 26 The lines according to the voltage level of the Transmission System

The exchange technical capacity with neighbouring countries is sufficient to realize the necessary exchanges and transits of electricity required at any time, however in certain periods, there is congestion of transmission capacities in interconnection.

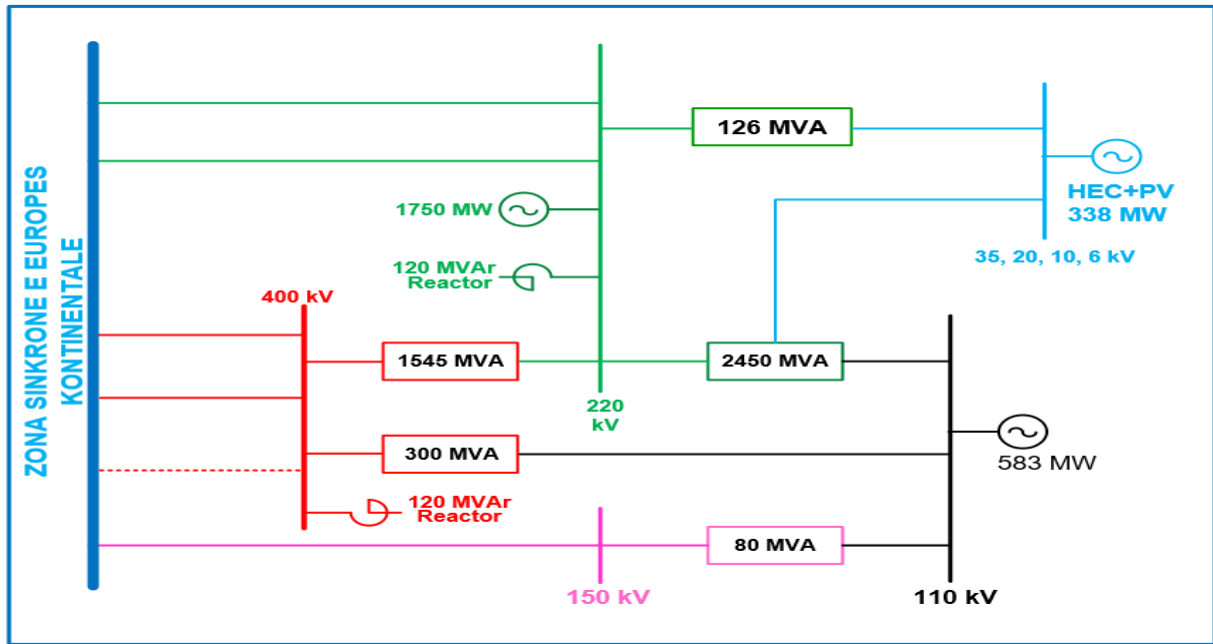

Figure 27 Structure of the Transmission System in Albania

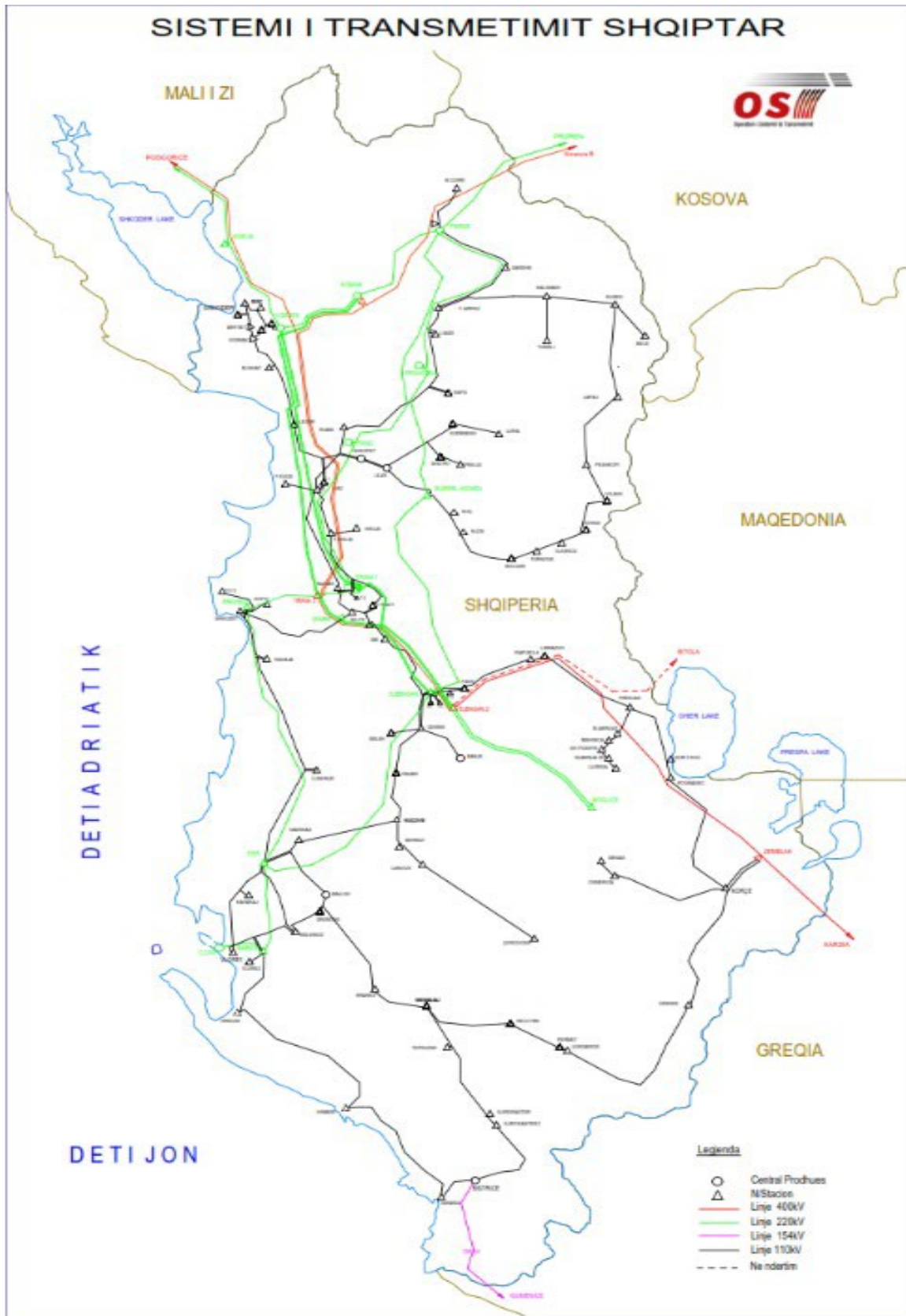
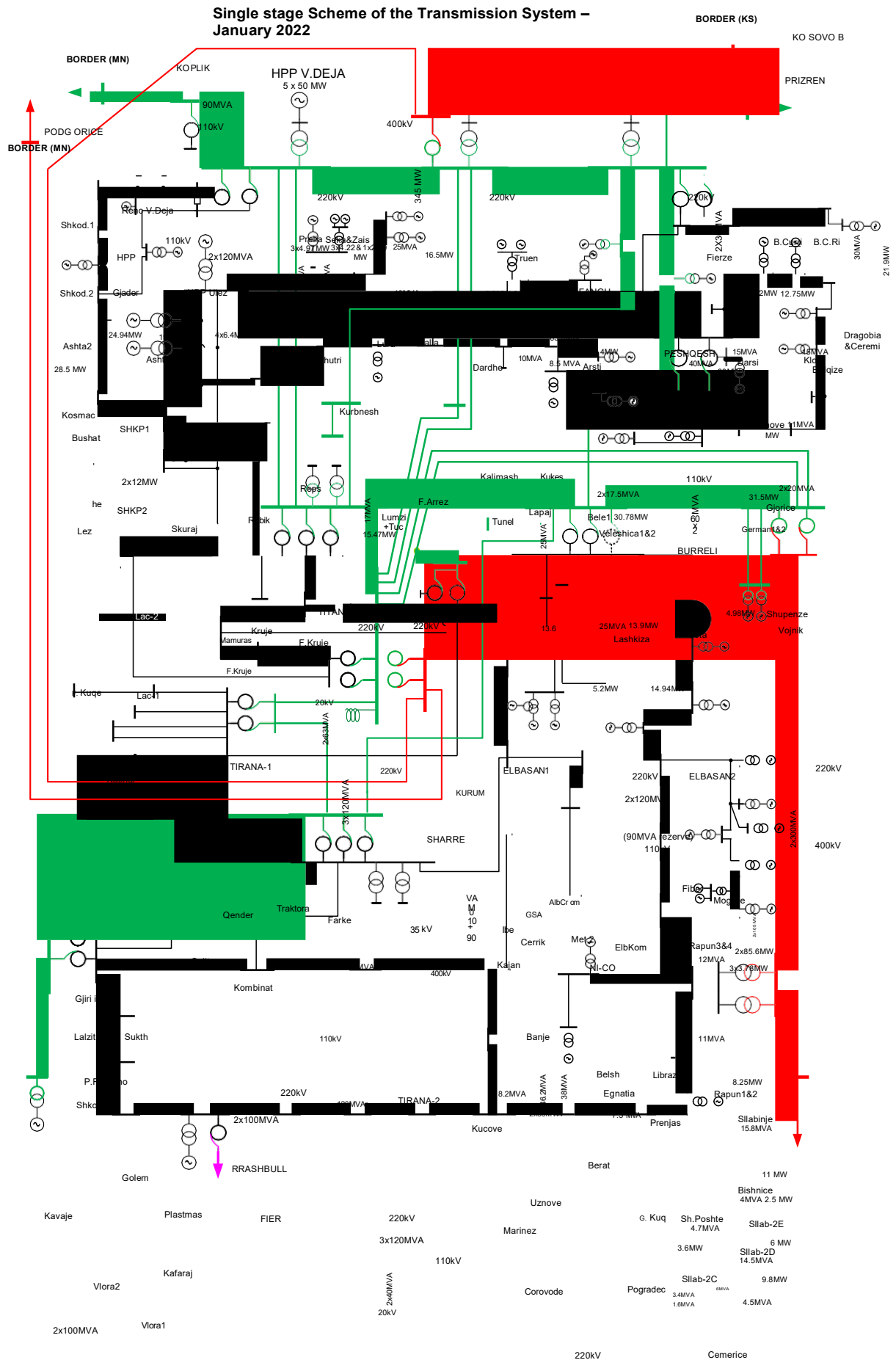

Figure 28 Scheme of the Albanian Transmission System



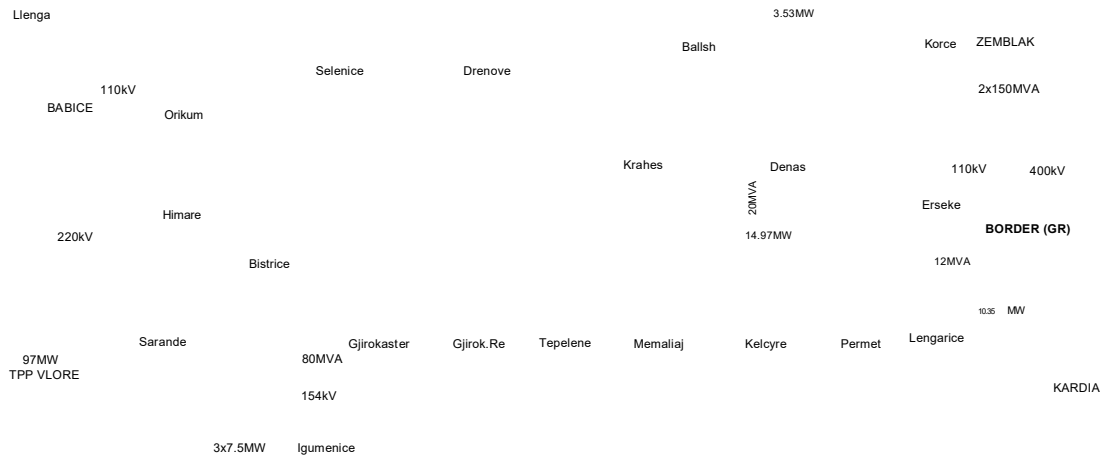

Figure 29 Single stage scheme of the Albanian Power System 400/220/150/110kV level

On the following table are listed the main substations of the transmission system and the installed capacity for each substation.

No	Substation	Installed capacity (MVA)	
1	400 kV	400/220kV Koman Substation	345
2		400/220kV/110kV Tirana 2 Substation	840
3		400/220kV Elbasan 2 Substation	600
4		400/110kV Zemblak Substation	300
5	220 kV	220/110kV V.Dejës Substation	240
6		220/110kV Fierzë Substation	120
7		220/110kV Koplík Substation	90
8		220/110kV Burrel Substation	120
9		220/110kV/20kV Tirana1 substation	486
10		220/110kV Sharrë Substation	190
11		220/110kV Rrashbull Substation	200
12		220/110kV Elbasan 1 Substation	330
13		220/110kV Fier Substation	360
14		220/110kV Babicë Substation	200
15	150 kV	110/150kV Bistrice 1 Substation	80
Total		4501	

Figure 30 Substations of the transmission system

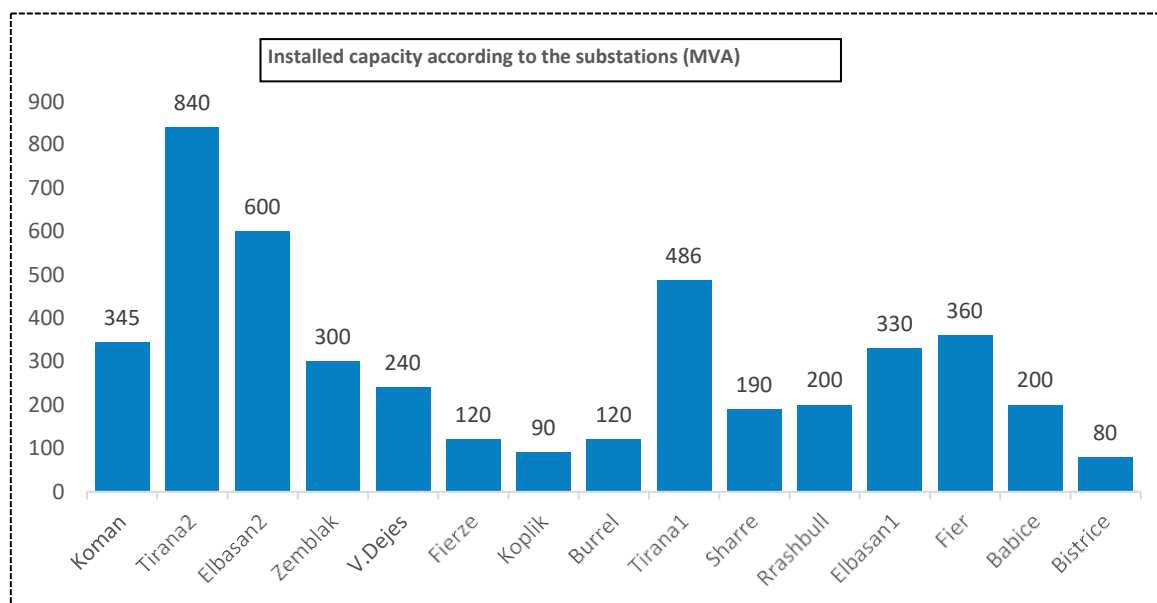

Figure 31 Main assets of the transmission system

The investments to the transmission system from TSO company during 2022

The realization of the Investments during 2022, from TSO company, in the framework of the investments approved in the 10-year development Transmission network for 2022 and the one approved from the Supervisory Council of the Company.

TSO company as the sole operator of the transmission system at the country has the legal obligation to draft the ten-year Development of the Albanian Transmission Network.

Currently, it is still implemented the ten-year Transmission Network Development Plan for the 2015 - 2025 period approved by ERE on 2017, periodically updated.

On the table as follows it is submitted the updated list of this plan which includes the amended commissioning year for those projects which are in process or are included to investments.

	Facilities	Type of Conductor (mm ²)	Length (km)	Capacity (MVA)	Commissioning Year	Value (Euro)
1	110 kV Uznove – Corovode connection and exit 110 kV Uznove	ACSR 240/40	33	122	2015	3,320,000
2	110 kV Lapaj – Peshkopi connection and two exits 110 kV	ACSR 240/40	32	122	2015	3,500,000

3	Purchase of two AT 220/110/10 kV Burrel	2x 60 MVA	-	12 0	2015	1,600,00 0
4	Purchase of one AT 220/110/35 kV Elbasan	1x120 MVA	-	12 0	2015	1,200,00 0
	Purchase of one AT 220/110/35 kV Elbasan	1x120 MVA	-	12 0	2017	1,200,00 0
5	110 kV connection with two circuits Burrel- Bulqize and two line exits 110 kV	2xACS R 240/40	30	12 2	2022	4,000,00 0
6	110 kV new connection, Rrashbull- Golem-Kavaje	2xACS R 240/40	18	-	2016	1,700,00 0
7	Connection with two circuits Ulez- Shkopet - Skuraj;	2xACS R 240/40	10.5		2016	1,800,00 0
8	Connection with one circuit Skuraj - Lac- 1	ACSR 240/40	12.7		2019	1,800,00 0
9	Connection with one circuit Skuraj -Lac- 2	ACSR 240/40	10.1			
10	Connection with two circuits Lac2 - Lac1	2xACS R 240/40	2.7			
11	Strengthening line 110 kV, Lezhe-Laçi 2	ACSR 240/40	19.5	-	2023	1,700,00 0
12	Strengthening line 110 kV, Ulez- Kurbnesh	ACSR 240/40	23.0	-	2025	2,000,00 0
13	New line 110 kV, Lapaj-Lure, 2 exit lines 110 kV	ACSR 240/40	19.0	-	2023	1,600,00 0
14	New line 110 kV, Sukth- Gj. Lalzit, 2 exit lines 110 kV	ACSR 240/40	18.0	-	2020	1,900,00 0
15	New line 110 kV, Bulqize- Ternove-Gjorice	ACSR 240/40	20.0		2025	1,900,00 0
16	220/110 kV Fierze, 1 Transformer exit 220 kV, 1 Transformer Exit 110 kV	-	-	2 x 60	2020	2,000,00 0

17	New line 110 kV, Kukes-Prizren, 1 Line exit 110 kV, Kukes substation	ACSR 240/40	13.0	-	2024	1,500,000
18	Line strengthening 110 kV, Elbasan1 - Fiber, Fiber-Librazhd	2 x ACSR 240/40	30.0	-	2024	3,000,000
19	Line strengthening 110 kV, Elbasan1 – GSA – Cerrik - Kajan	ACSR 240/40	24.0	-	2023	2,040,000
20	Line Strenghtening 110 kV, Kajan-Kucove-Marinez-Fier	ACSR 240/40	59.0	-	2023	5,015,000
21	New line 110 kV, Fier-Lushnje	ACSR 240/40	30.0	-	2024	2,400,000
22	Completion of the second circuit of line 220 kV Fier-Babice- Vlore TPP	ACSR 490/65	35.0	-	2024	1,000,000
23	New line 110 kV, Ballsh-Memaliaj	ACSR 240/40	48.0	-	2025	7,080,000
24	Completion of the second circuit 110 kV line, Kuçove-Uznove-Çorovode	ACSR 240/40	58.0	-	2025	1,000,000
25	New line 110 kV, Tirana1-Qender (Cable), 1 line exit 110 kV.	XPLE- AL100 0	2.3		2024	1,500,000
26	New line 110 kV, Koplik-Shkodra1	ACSR 240/40	20	-	2025	1,700,000
27	New line 110 kV, Kosmac-Velipoje	ACSR 240/40	28	-	2025	2,380,000
TOT						59,835,000
AL						00

Figure 32 Approved 10-year development plan of Transmission Network Development 2015 – 2025

About 82% of the projects submitted above, are expected to terminate within 2023. The other part is expected to be realized within 2025. The large-scale implementation of this 10-year program of the investments except of other aspects brought the need to perform the study of the Development of the Master Plan of the Transmission Network for 2018 – 2033 period and the draft of the New Development Program for the 2026 – 2036 period.

TSO company, through the official communication submitted at ERE for review the summarized report of the new ten-year development program of the transmission system for 2026 – 2036 period. The remaining part of the investments shall be included to the new ten-year plan as a continuation of the current plan 2015 – 2025 and the new objectives / strategies in the power sector reflecting the response to new challenges for a sustainable and optimal development of the transmission network on the country.

On the table as follows it is submitted the realization of the investments of TSO company for 2022 with TSO company funds.

Year	No.	Description	Contract Value	Realized value to 2021	Realization 2022	
					Realized Value	Contract Realization %
2016	1	Reconstruction of 110 kV Kalimash-Tunel line	5,979,267	3,421,650		57%
	TOT Contracts for 2016			5,979,267	3,421,650	0
2018-2019	1	Reconstruction of 110 Plant of Librazhd substation	99,942,557	93,049,917	6,892,641	100%
	2	Construction of a substation near the 400/220/110 kV Tirana 2 substation	36,503,650	36,503,650	0	100%
	3	Rehabilitation of the 110 kV side of Ibe Substation, 3804/12 contract	96,558,880	96,558,880	0	100%
	4	Supervision of the work for the contract: Reconstruction of the Plant 110 kV of Librazhd substation	1,100,000	990,000	110,000	100%
	5	Reconstruction of the Lines 110 kV Laç 1-Ura e Matit and Skuraj- Ura e Matit	194,391,996	194,391,996	0	100%
	6	Construction of the Substation 220/110/35 kV, amounts and the track 220 kV, n/stacioni 220/110/10 kV Komsj substation	720,206,000	613,222,800	88,004,000	97%
	7	Construction of the line 220 kV with two circuits Komsj-Shumat	999,978,462	729,927,772	0	73%
TOT Contracts for 2018 and 2019			2,148,681,545	1,764,645,015	95,006,641	87%
2020	1	Construction of the line with two circuits 110 kV Fibër-Librazhd and respective line tracks in Fibër and Librazhd substation	386,942,700	132,962,919	253,978,886	100%
	2	Expansion of the localization system mitt of the High Voltage Line defects	99,730,002	99,730,002	0	100%
	3	Construction of the new line with two circuits 110 kV Burrel - Bulqizë and rehabilitation of the 110 kV Burrel and Bulqizë substation	655,700,000	146,980,000	0	22%
	4	Construction of the new line 110 kV with one circuit Cerrik-Kajan_ Kuçovë-Jagodinë. Rehabilitation of the Substation Cerrik&Kuçovë	570,250,000	353,548,400	202,816,800	98%
	5	Works for terminating the cable line 110 kV Tirana-Selite and the connection with the 110/20 kV Kombinat substation	54,221,811	54,221,811	0	100%
	6	Improvement of the network infrastructure and the security increase within TI infrastructure	20,785,500	20,785,500	0	100%
	7	Reconstruction of the lines 110 kV Laç2-Ura e Matit and Skuraj Ura e Matit	2,100,000	2,100,000	0	100%
	8	Relocation of the air line 220 kV double circuit Tirana 2 - Elbasan 2	27,830,459	25,556,419	2,274,040	100%
	9	Construction of 220 Kv line with two circuits Komsj-Shumat	11,000,000	6,050,000	945,522	64%
	10	Supply, installation and configuration of 2 online systems of insulators and the partial discharge of TR capacity AT1 and AT2 220/110/10 kV Burrel substation	34,160,000	32,360,000	0	95%
TOT Contracts for 2020			1,862,720,472	874,295,051	460,015,248	72%
2021-2022	1	The expansion and increase of the transmission capacities over the network OPGW	37,476,340	37,476,340	0	100%
	2	Improvement of central infrastructure, TI platforms and systems	13,090,000	13,090,000	0	100%
	3	Purchase of the exchange equipments for the telecommunication equipment network	7,680,000	7,680,000	0	100%
	4	Construction of the new 110 kV line, double circuit Elbasan-Cerrik	209,396,822	41,879,365	0	20%
	5	Reconstruction of the 110 kV Librazhd – Prrenjas line	305,281,965	61,056,394	40,702,370	33%
	6	Primary works, supply and set of the transformer TR 63 MVA?N/st Tr 1	158,161,100	127,312,220	30,848,881	100%
	7	Construction of the new 110 kV line, double circuit Elbasan Fiber Substation	191,875,723	38,375,145	0	20%
	8	Hardware Installation and PLC logistic implementation on LFC management regarding the local control systems of TSO network users	12,870,000	12,870,000	0	100%
	9	Line Reconstruction 110 kV Lushnje - Fier	246,246,000	49,249,200	0	20%
	10	Surveillance of the works during the implementation of the contract for the Expansion of the defects localization system at the high voltage lines	863,183	863,183	0	100%
	11	Surveillance of the works for the facility: Construction of the 220/110/35kV substation, amounts and track 220kV to the 220/110/10kV Komsj substation	6,303,477	4,727,608	1,210,000	94%
	12	Line reconstruction 110 kV Ulëz -Burrel,	41,090,010	8,218,002	32,872,008	100%
	13	Surveillance of the works for the facility: Works for the termination of the 110 kV line Tirane Selite and the connection with the 110/20 kV Kombinat substation	376,350	376,350	0	100%
	14	Expansion of system localization of the defects to the High Voltage lines	115,826,000	115,826,000	0	100%
	15	Supply and Installation of a 400 kV 120 MVA Shunt Reactor and the track 400 kV at Tirana 2 Substation.	538,936,701	211,848,540	327,088,161	100%
	16	Upgrade, maintenance and training of the main system SCADA/EMS	414,912,935	88,521,727	74,437,292	39%
	17	Surveillance of the works for the contract of the facility: Rehabilitation of the side 110 kV of the substation Ibe	1,100,000	1,100,000	0	100%
	18	Surveillance of the works for the Cerrik-Jagodine line	5,600,000	2,815,804	2,489,200	95%
	19	Surveillance of the works for the contract: Expansion of the localization system of the defects to LTL- HMK	530,000	530,000	0	100%
	20	Surveillance of the works for the contract: Postponement of the air line 220 kV 220 kV double circuit Tr2-Elb2	330,500	330,500	0	100%
TOT Contracts for 2021			2,307,947,105	824,146,376	509,647,912	1
2022	1	Civil works for the tracks and the 110 kV line of the Operational Unit	19,503,726		12,561,464	64%
	2	Construction of the AT 110 MVA understructure of 220/110/35 kV Sharre Substation	3,474,373		3,474,373	100%
	3	Surveillance of the works for the contract "Construction of the AT 110 MVA understructure Sharre substation"	26,564		26,564	100%
	4	Supervision of the works for the contract "Supply and Installation of a 400 kV 120 MVA Shunt Reactor and the 400 kV track of Tirana 2 Substation.	1,395,178		1,395,178	100%
	5	Supervision of the works for the contract "Primary works, supply and set of transformer TR 63 MVA Tr 1 Substation "	912,246		912,247	100%
	6	Supervision of the works for the contract "Construction of the double circuit line 110kV Fibër-Librazhd and the respective track lines for Fibër and Librazhd substation	3,386,648		3,386,648	100%
	7	Construction of the monitoring environment helpdesk for TSO services	11,825,000		11,825,000	100%
	8	Surveillance of the works for the reconstruction of 110 kV Ulez-Burrel line Atelier 4	655,415		655,415	100%
	9	Upgrade and maintenance of the online metering platform - S.A.N	25,100,000		25,100,000	100%
	10	New Auto-transformer purchase 300 MVA, 400/230 kV for Tirana 2 substation - Alb-Star	284,481,580		284,481,580	100%
	11	Supervision of the works for the contract "Civil works for the tracks and lines of 110 kV Operational Line? ? Atelier 4	425,016		238,005	56%
	12	Surveillance of the works for the reconstruction of the 110 kV Librazhd – Prrenjas line ? HMK Consulting	2,134,000		355,738	17%
TOT Contracts for 2022			353,319,746	0	344,412,215	
Total Investments 2022			6,678,648,136	3,466,508,092	1,409,082,016	

Figure 33 Investments realized from TSO company with its own funds 2022

On the following table are reflected the investments of TSO company for 2022 with foreign funds:

No.	Description	Amount of the Contract		The amount realized until 2021		Realization for 2022		
		EUR	ALL	EUR	ALL	EUR	ALL	Realizimi Kontr. %
1	<i>"Energy Efficiency" Project</i>	40,221,736	4,897,800,837	9,063,981	1,115,317,991	5,822,753	665,133,114	37%
	Contractor	37,598,121	4,578,323,238	5,782,437	705,084,348	5,281,365	603,290,286	29%
	Consultancy	2,623,615	319,477,599	2,172,629	273,103,315	286,111	32,682,442	94%
	Interests & Commitment Commissioning and Local Costs			1,108,915	137,130,328	255,278	29,160,386	
2	<i>Project "400kV Macedonia- Albania line"</i>	48,280,598	5,879,128,421	2,066,256	252,667,228	1,256,695	143,552,316	7%
	Contractor	45,815,978	5,579,011,643	430,618	52,218,484	536,714	61,308,869	2%
	Consulence	2,464,620	300,116,777	1,338,602	164,178,646	532,266	60,800,775	76%
	Interests & Commitment Commissions and Local Costs		0	297,036	36,270,099	187,715	21,442,672	
3	<i>Metering Installation /Center of the data</i>	13,038,004	1,587,637,761	12,806,316	1,629,207,568	0	0	98%
	Contractor	13,038,004	1,587,637,761	12,739,821	1,613,577,785			98%
	Consulence		0	0	0			
	Interests & Commitment Commissions and Local Costs			66,496	15,629,784			
TOT		101,540,338	12,364,567,019	23,936,553	2,997,192,788	7,079,449	808,685,430	31%

Figure 34 Realized investments from TSO company with foreign funds

1.3.3 General Condition of the Power System referring to the reporting of TSO company

TSO company, according to the effective legal and regulatory framework is responsible for the operation, maintenance and development of the transmission system. TSO company realizes these obligations based on the requirements and principles of operational security and the guarantee of the transmission system coordination in high coordination, reliability, qualitative and sustainable level.

Operational security of the network

The ability of the transmission network to remain in a normal state and / or the ability to return to a normal state as soon as possible, is characterised from the operational security limits. As consequence the transmission system is considered in a normal state when there are fulfilled all of the conditions as follows:

The voltage levels and the power flows are within the operational security limits defined on articles 111 and 113, in conformity with Article 109(5) of the Transmission Code and within the interval defined on the "Regulation for the quality of supply and network security performance of the electricity transmission system", approved with ERE Board Decision no. 207, dated 18.12.2017.

Frequency of the system shall be within +/- 200mHz range, defined on the Transmission Code and the "Regulation for the quality of supply and network security performance on the electricity transmission system", approved with ERE Board Decision no. 207, dated 18.12.2017.

The reserves of active and reactive power shall be sufficient to deal with the unplanned events, without violating the operational security limits.

The operation of the TSO responsibility area shall remain within the operational security limits even after the activation of correction actions, after the occurrence of a contingency.

For all of the above mentioned, analysing every process, that shall be considered essential to manage the operation of the transmission system, and to maintain the operational security of the network, TSO company reported for 2022 including as follows:

- operational planning;
- schedule;
- real time operation,
- allocation and planning of the reserves and ancillary services;
- measures for the protection and restoration of the system.

1.3.3.1 Voltage levels

On the provisions of the Transmission Code and the Regulation approved with ERE Board Decision no. 207, dated 18.12.2017 on the “Quality of Supply and Security Performance to the Electricity Transmission System” it is defined that the TSO company shall respect the voltage ranges and levels as follows:

- For the 400-kV level the permitted range from 0.9 pu to 1.05 pu.
- For the voltage level 220/154/110 kV the permitted voltage is 0,90 pu to 1,118 pu.

The voltage level on the transmission network shall depend on the network development, its typology, as well as the distribution of the generation and consumption on this network. The Albanian Power System at the north – east region of the country have installed the biggest part of generations from where it is injected the energy to the network, as consequence on large rainy sessions, where even the generation of the plants is on maximum, are shown relatively high voltages, but have not overcome the ranges threshold defined on the Transmission Code. The detailed information on the voltage levels during 2022 are mentioned on point 12 of this document.

Regarding the maintenance of the normal situation of the system, the operational stadd of the respective Dispatch Center of the TSO and DSO companies, during 2022, has been at any moment ready, by coordinating the performance of operational actions in a shortest time possible, by continuously controlling, the load of the lines in general but prioritizing 110 kV line, as the most problematic part of the system. On every moment if there are observed the violation of the operational safety limits, the staff is guided to intervene by activating the ancilliary services. Specific importance is given to the 110 kV lines, if the current in the line reach the maximum protection settings of overcurrent, and this value remain stable and with an increase tendency. The TSO and DSO operators perform the assessment of the situation, the verification of the loading parameters and if are confronted with an increase tendency of the load (I) initiate to activate the ancilliary services to the moment the system returns again to the normal and stable status.

Shall be mentioned that during 2022 except of the topology to the system and the issues observed to the observed problems in the 110-kV network the voltage levels remained within the defined ranges of the Transmission Code and the Regulation approved with ERE Board Decision no.207, dated 18.12.2017 for the “Quality of Supply and Performance to the Electricity Transmission System Network”.

1.3.3.2 Frequency control

The frequency control for the Transmission system is currently managed automatically from the FCR and aFRR. Sometimes, the additional reserves are activated manually (mFRR or RR). The preventive actions FCR and aFRR are continuously activated to counteract the system imbalances. The curative actions mFRR and RR are activated manually from the QKD Operators. Implementing the requirements and definitions of the effective legal framework, the TSO company receives the balancing services from the qualified Generators as the Balancing Service Provider.

Active and reactive power reserves

During the sufficient assessment process in the responsibility area, the TSO evaluates the possibility of meeting the country's total demand, by considering the available generation from all generators in combination with the capacity of interconnection lines, using various operational scenarios while considering the required level of active and reactive power reserves.

According to the Transmission Code, the ENTSO-E Operational Manual (SO-GL), and ERE Board Decision no. 106 dated 02.07.2020 on the Albanian Electricity Balancing Market Rules, the TSO company procures the balancing reserve necessary to maintain the balance of the control area continuously.

The operation of TSO responsibility area

Planning

The concepts of the system operation often come with new characteristics that may require adoptions to existing processes and the development of new supporting systems. Such requirements need to be planned and fulfilled before the concepts are implemented and used in operations. Especially when the concepts involve multiple TSOs, cooperation between TSOs is crucial to ensure the continuity of operational security. As the facilities of the DSOs and SGUs may be important in several concepts, coordination with DSOs and SGUs in operational planning and real-time becomes increasingly important.

The TSO plans the development of the transmission system in accordance with the (N-1) criterion of Operational Security. The TSO collaborates with adjacent TSOs to coordinate the development of the interconnection network while also considering the development of the network/facilities of transmission system users in the planning and developing the transmission network.

Long-term planning

The main purpose of the long-term planning is to identify the future structural congestions in the network, usually thanks to security analysis N-1 or N-k and then the best way to settle them. Two main mechanisms for such studies of the network are:

ad-hoc studies of the network (the time frame < 5-10 years): stimulated from local modifications in the network, for example in the case of new request for a switch in the network or deactivation of the main element in the network;

long term development planning (the time frame > 5-10 years): global and strategic studies performed regularly, considering the national and international development of the network.

Traditionally this is the main solution to eliminate the weak points of the network development, by constructing new transmission cable lines or installing transformers. However, since it is difficult to implement such a solution (the higher costs, long duration of the project) from TSO company are considered new and innovative solutions such as the specific protection schemes or the set of control equipments.

Mid term planning

The mid term planning covers the activities from the current year and in continuation. On this framework, TSO company is focused on planning the disconnections, which shall be coordinated if affecting the operation of adjacent systems. This includes its assets, as well as the generation units and other important facilities. The importance of the necessary assets to coordinate derives according to the methodology, that includes the qualitative and quantitative aspects such as the approximation with the borders of a control area or the effect with electricity values from the simulations of the energy flow.

Short term planning

The short-term planning includes several sub-processes. The week ahead process deals with the planning of the disconnections with a short notification (the request for the next week) and the activation of additional plants, which are necessary to maintain the safety of the system.

The capacities allocation initiates two days ahead and defines the maximum transferring capacities between different bidding areas. The assessment is repeated one day ahead and within the day.

The day ahead process is concentrated on improvement actions to prevent all congestions, which may occur on the next day. Typically, the correction actions are planned on national level and then are coordinated with all the respective adjacents. The results from planning the day ahead are improved within the day, based on new provisions. The analysis in planning the day ahead is based on the models of a sustainable situation.

Real time operation

For the real time operation, the TSO monitors and accesses the safety of the transmission system through the analysis for the sustainable situation. There are also verified the preventative correction measures defined from the operational planning. If there are identified possible congestions or violations of the voltage level, the operator shall undertake reasonable correction actions to settle the issues. Due to time restrictions, the operator shall make the assessment without the support of the optimization means. If a real contingency occurs, the operator shall reset N-1 security as soon as possible. In case of emergency situations there is implemented the actions from the protection plan. The frequency control is automatized. The manual actions from the operator are necessary if there occur larger deviations of the frequency or if the reserves for the frequency control are nearly exhausted.

The cooperation operational protocol for the real time operation between the TSO and the DSO companies.

Both Dispatch centers (TSO and the DSO) monitor the main parameters of the Power System such as current, voltage to the transmission lines and especially Tirana region lines, respectively each on its supervision areas.

In case of an emergency, the Operators of the Distribution System Operators (DSO) and Transmission System Operator (TSO) substations receive signals from protection actions and report to their respective Dispatch Centers. Based on their assessment, when deemed necessary, the TSO and DSO Dispatch Centers collaborate for the prompt restoration of the affected element. To reduce the disconnection time, shall be assessed any other information that is taken in an operational way regarding the switched element.

In cases when the re-switch is unsuccessful, both Dispatch centers take the final re-configuration measures of the scheme, according to the regimes set after the defect, as above with the obliged restrictions of energy. This situation happens to the normalization of the situation.

The Systems of Automatic Control – Monitoring

To comply with the objectives, the TSO shall enable the automatic control of the transmission network through local control systems (installed systems to substations) and through SCADA/EMS systems, systems in operation from the Dispatch Operators. These systems enable the real time monitoring and operation of all 220/400 kV substations, and the largest and important part of the 110 kV substations. Besides the Substations are monitored and operated the Plants connected with the transmission system. Currently TSO monitors in the real time to the system the data as follows: a) active and reactive load flows; b) voltage in the busbar; c) line currents, Transformers and other elements of the transmission system; d) frequency and the control error to reset the frequency at the LFC area; e) monitoring and control of the AK Block (TSO - KOSTT); f) active and reactive power reserve; g) generation and consumption.

Despite the real time operation of the transmission system, at SCADA/EMS system are implemented the EMS network applications. EMS is the network package application, which through internal studies of the system, based on its current situation and the parameters for each element of the power system included at SCADA, shall optimize the system situation. Above other functions, EMS covers: a) the decision-making support; b) control over generation; c) energy planning; d) safety analysis; e) support for possible maneuvers; f) monitoring of the power network.

EMS module is composed of some applications which cooperate in the network with each other and at the same time may be individually managed from each other. Each of the network applications included on the EMS package is implemented as software package, allocated from other applications, but are confronted between them by the real time data. Modularization in this way provides facilities in managing the EMS package in general. In addition to studies on the stations from which they are monitored in the real time, EMS, based on reference data, also conducts studies on other substations that are not included in the monitoring.

At the TSO company control center, the AGC (Automatic Generation Control) package has been implemented, the module which regulates the generator output in order to keep the frequency and exchange at the scheduled values. This module is configured in accordance with the operational manuals published by ENTSO-E.

The main module of the AGC package is LFC (Load Frequency Control), an application that collects,
Blv. “Bajram Curri”, Rruga “Viktor Eftimiu” 1023, Tiranë
www.ere.gov.al

Tel/Fax: +355 42 22 963
e-mail: crealb@ere.gov.al

analyzes and prepares input data, calculates the control error of the area (deviation from planned values - ACE) and from that calculates the total required energy change of TSO company in Albania. The deviation from the planned values is sent as a request for contribution to all units that are under the control of the LFC.

TSO company has a dedicated telecommunications network for the safe operation of the system. TSO company has a backup control center connected to the security telecommunication network which is equipped with control equipment. All data that is received remotely is called or obtained and processed in a dual way through different channels.

1.3.4.2 Management of energy flow

The management of energy flow deals with the establishment or the definition of operational means to maintain the energy flow within the operational safety limits at each element of the transmission system. To monitor and control the operational parameters it is necessary an accurate information on the system situation and its assessment. TSO company controls the operational parameters within its responsibility area and in a coordinated way, shall take into consideration the operational parameters from the observation area that include part of adjacent TSO-s.

Any element of the Transmission System, has its operational security restrictions in the upstream of energy flow. These restrictions are important for the protection of the equipments and the persons near a certain element of the Transmission System, taking into consideration the technical restrictions of the used materials, to avoid damage or premature aging of the equipment. To be able to confront with the emergencies in the system, from TSO company are prepared the improving and coordinated individual actions which are implemented when necessary, to prevent the violation of operational security limits and to support the return to normality in cases of alarm or emergency status.

1.3.4.3 Contingences analysis and their handling

TSO company receives security analysis from the Security Coordination Center, SCC Ltd. Belgrade (Regional Security Coordinator for SEE), through a contract as a user of the services of SCC Ltd. Belgrade. This contract includes the 5 services as follows:

- the evaluation and improvement of the individual/joint network model (IGM/CGM);
- coordinated calculation of the capacity (cross border);
- coordination of safety analysis (including the improvement and repair measures);
- work sufficiency and reliability in low and mid terms;
- coordination of repair planning.

The security of system operation is the reason for the realization of contingency analyses, which TSO company realizes by simulating the switch of the elements of the transmission system. This analysis is performed using the individual model of TSO company and the common model of the network, respecting the limits of operational security and in the meantime the preparation is made for the performance of corrective actions before and after the incident, when required by the result of the analysis. The main principles that are followed in relation to the analysis of contingencies are:

Ensuring prevention and/or improvement in terms of remedial actions, required to maintain operational safety, for all credible contingencies affecting the transmission system;

Coordination of analysis and remedial actions whenever necessary, to ensure the desired result - maintaining operational security in the system and in the interconnection;

Relying on the appropriate data and information in real time and those based on load foreseen. The use of the common model of the regional network and the exchange of all necessary data and information between TSO company, OSHEE company and important network users.

From the Report it is noted that TSO company has not in any case violated the security of operation throughout 2022 period in the Electricity Transmission network.

1.3.4.4 Management of dynamic sustainability

TSO monitors the dynamic sustainability of the transmission system in the terms of voltage, frequency and the stability of the rotor angle, with off line studies, with wide area measure, including the exchange of the relevant data with other TSO-s when necessary, to be able to take the correction measures when the operational security of the system is in danger. The purpose of the dynamic off-line studies is to ensure the awareness of the TSO operator regarding the current situation and the future provision of the system situation regarding the stability in (N) situation and the possible one (N-1). Despite that, such studies help in decision process for the efficient improvement actions, to prevent the incidents if they happen or the correction of their consequences.

During 2022, no events or violations of operational safety limits were recorded in the electricity transmission system, the transmission system operated stably in normal operating conditions.

Estimated balance of request and electricity supply in the internal market for a five-year period.

Based on the historical data of TSO company and considering the potential increase of PPE + PVE and the reduction of non-technical losses in the distribution network, it is accepted that the expected increase of the electricity volume transmitted by the TSO, shall be at 1% rank. Over this basis, using the loading profile on hourly basis for each month average day, the provision of the main electricity parameters and the security of the System balance for the five years 2023-2027, as provided in the following tables:

No	Name	Metering Unit	1	2	3	4	5	6	7	8	9	10	11	12	Viti 2023
I.	Total energy introduced to the TSO system	GWh	868	769	840	765	761	630	777	835	677	813	856	1023	9,614
a)	Domestic Production	"	559	552	667	569	505	378	464	467	361	426	423	583	5,954
b)	Received electricity	"	309	217	173	196	256	252	313	368	316	387	433	440	3,660
II.	Total transmitted electricity	GWh	849	752	822	749	745	613	759	817	661	796	838	1,003	9,404
a)	Provided electricity	"	86	82	99	160	181	36	90	145	100	201	217	217	1,614
b)	Electricity for OSHEE company	"	688	605	648	494	464	482	569	567	461	500	526	711	6,715
c)	Electricity for qualified customers	"	75	65	75	95	100	95	100	105	100	95	95	75	1,075
III.	Losses to the transmission network	GWh													
a)	Losses in GWh	"	19	17	18	16	16	17	18	18	16	17	18	20	210
b)	Losses in %	%	2.16%	2.21%	2.10%	2.14%	2.15%	2.63%	2.34%	2.21%	2.36%	2.08%	2.14%	1.93%	2.19%

No	Name	Metering Unit	1	2	3	4	5	6	7	8	9	10	11	12	Viti 2024
I.	Total energy introduced to TSO system	GWh	895	803	933	866	801	717	713	709	637	797	889	1065	9,825
a)	Domestic production	"	565	555	670	580	555	390	450	450	365	415	460	585	6,040
b)	Received electricity	"	330	248	263	286	246	327	263	259	272	382	429	480	3,785
II.	Total transmitted electricity	GWh	875	785	915	850	785	700	695	690	620	780	870	1,045	9,610
a)	Provided Electricity	"	105	120	220	230	220	125	15	5	55	170	240	235	1,740
b)	Electricity for OSHEE company	"	675	580	600	530	470	485	590	595	480	510	520	685	6,720
c)	Electricity for the qualified customers	"	95	85	95	90	95	90	90	90	85	100	110	125	1,150
III.	Losses to the transmission network	GWh													
a)	Losses in GWh	"	20	18	18	16	16	17	18	19	17	17	19	20	215
b)	Losses in %	%	2.23%	2.24%	1.93%	1.85%	2.00%	2.37%	2.52%	2.68%	2.67%	2.13%	2.14%	1.88%	2.19%

No	Name	Metering Unit	1	2	3	4	5	6	7	8	9	10	11	12	Viti 2025
I.	Total energy introduced to the TSO system	GWh	906	863	948	816	786	763	834	810	677	752	839	941	9,935
a)	Domestic production	"	580	560	675	595	570	400	490	490	365	405	435	560	6,125
b)	Received electricity	"	326	303	273	221	216	363	344	320	312	347	404	381	3,810
II.	Total transmitted electricity	GWh	885	845	930	800	770	745	815	790	660	735	820	920	9,715
a)	Provided Electricity	"	110	175	225	170	205	165	125	85	90	130	185	105	1,770
b)	Electricity for OSHEE company	"	675	575	600	535	475	485	590	600	480	510	520	685	6,730
c)	Electricity for the qualified customers	"	100	95	105	95	90	95	100	105	90	95	115	130	1,215
III.	Losses to the transmission network	GWh													
a)	Losses in GWh	"	21	18	18	16	16	18	19	20	17	17	19	21	220
b)	Losses in %	%	2.32%	2.09%	1.90%	1.96%	2.04%	2.36%	2.28%	2.47%	2.51%	2.26%	2.26%	2.23%	2.21%

No	Name	Metering Unit	1	2	3	4	5	6	7	8	9	10	11	12	Viti 2027
I.	Total Energy introduced to TSO system	GWh	952	898	974	866	812	789	850	835	717	774	835	973	10,275
a)	Domestic Production	"	590	565	700	610	575	430	535	540	370	415	440	565	6,335
b)	Received Electricity	"	362	333	274	256	237	359	315	295	347	359	395	408	3,940
II.	Total transmitted electricity	GWh	930	880	955	848	795	770	830	815	700	755	815	950	10,043
a)	Provided electricity	"	130	190	240	210	220	180	120	100	125	140	170	120	1,945
b)	Electricity for OSHEE company	"	675	575	595	530	470	480	590	595	475	505	515	685	6,690
c)	Electricity for the qualified customers	"	125	115	120	108	105	110	120	120	100	110	130	145	1,408
III.	Losses to the transmission network	GWh													
a)	Losses in GWh	"	22	18	19	18	17	19	20	20	17	19	20	23	232
b)	Losses in %	%	2.31%	2.00%	1.95%	2.08%	2.09%	2.41%	2.35%	2.40%	2.37%	2.45%	2.40%	2.36%	2.26%

Figure 35 Foreseen balance of the request and electricity supply in the internal market for 2023 – 2027 period

Expected level of demand and security perspective of supply for a five to fifteen years period.

In the framework of studying the “Investment Plan and the Development of the Network for the Electricity Transmission sector in Albania 2018-2033”, finalized during 2021, it is realized the long-term planning of the request for a time horizon up to 2040 according to different selected scenario.

The used methodology is firstly the provision of the total request of the country for electricity and then the specific request for electricity, through the application of the end-use model, that accesses the future demand for electricity for each sector of the economy based on mid-term to long terms scenarios of social – economic, technological and demographic developments. The provision of the demand is realized for the four scenarios defined as follows:

- high scenario – is based on modeling and does not include natural gas (does not provide additional gasification in Albania);
- moderated scenario – submits the scenario where the supply infrastructure with natural gas is available as one of the electricity forms for consumption;
- low scenario – it is supposed that the increase of the economy shall be slow (the migration shall be high and the increase of the population slower);
- high scenario with lower population – shall submit a high scenario with a slow increase of the population, proportional decrease of the GDP and without gasification of the country.

In conclusion there are two scenarios without gasification with high and low population and there are two scenarios with gasification of the country with a high and low population, the results of which are submitted at the following table and graph:

Request for electricity (TWh)	Year 2022	Year 2025	Year 2028	Year 2030	Year 2033	Year 2035	Year 2040
High Scenario	7.424	8.476	9.299	9.861	10.897	11.584	13.436
Moderate scenario	7.424	8.315	8.921	9.34	10.067	10.549	11.914
High scenario with low population	7.424	8.283	8.928	9.373	10.233	10.803	12.392
Low scenario	7.424	8.018	8.414	8.694	9.23	9.583	10.438

Figure 36 Longterm provision of electricity requirement for the 2023 – 2040 period

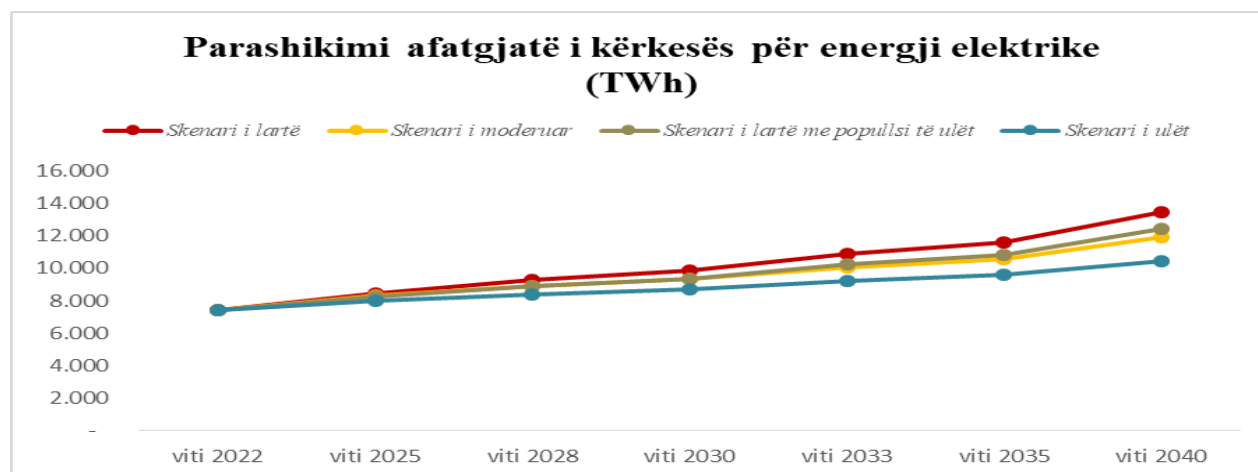

Figure 37 Scenarios for providing the request for electricity

Additional proposed, production capacity, the planned or in construction stage

The following data shall submit the power plants which are connected in the transmission network for 2022, that are on construction phase or have received the prior approval for connecting with the transmission network as follows:

The plants that have signed the agreement for connection to 2022 and are expected to be energized during 2022-2023 period:

- Stavec HPP-s (14.77 MW) – KOKA & ERGI company
- Kalivarë HPP-s (5.597 MW) – BE-IS ENERGY company
- Gostimë HPP-s (48.864 MW) – Egnatia Hydropower company
- Bushtrica HPP (10.03 MW) – ELENERGJI company + BUSHTRICA 2017 company
- Karavasta Photovoltaic Park (140 MWp) – KARAVASTA SOLAR company
- Blue1 Photovoltaic Park (57.6 MWp) – SPV Blue1 company
- Blue2 Photovoltaic Park (57.6 MWp) – SPV Blue2 company
- Qami1 HPP (1.73 MW) – Lajthiza Invest company
- Plants that have signed connections with the transmission system during 2022:
 - Blue1 Photovoltaic Park (57.6 MWp) – SPV Blue1 company
 - Blue2 Photovoltaic Park (57.6 MWp) – SPV Blue2 company
 - Qami1 HPP (1.73 MW) – Lajthiza Invest company
- Plants that received the approval in principle regarding the transmission system during 2022:
 - Erseka Solar1 Photovoltaic park (20 MW) – Erseka Solar Park1 company
 - Erseka Solar2 Photovoltaic Park (20 MW) – Erseka Solar Park2 company
 - Qami1 HPP (1.73 MW) – Lajthiza Invest company
 - Gojan HPP (15.3 MW) – MC ENERGI GOJAN company
 - GreeNNat Solar Photovoltaic park (100 MWp) – Greennat Solar Park Ballsh
 - Blue2 Photovoltaic park (100 MW) – SPV Blue2
 - ALB-Solar1 Photovoltaic park (50 MWp) - INFO-Telecom
 - Arsol Photovoltaic park (50 MWp) – ARSOL ENERGY
 - Premium Photovoltaic park (30 MWp) – PREMIUM ENERGY
 - Sharp Photovoltaic park (20 MWp) – SHARP ENERGY
 - Sheq-Marinas photovoltaic park (50 MWp) – NOVA SOLAR SYSTEM
 - Solergal Photovoltaic park (25 MWp) – EURON company
 - Agim photovoltaic park (50 MWp) – AGNA company
 - Aga Solar photovoltaic park (150 MWp) – AGA SOLAR company
 - Fortis photovoltaic park (38.92 MWp) – Fortis Energy and Construction company
 - Twin Sun Solar photovoltaic park (30 MW) – Alb Sun Energy company
 - Neon photovoltaic park (22.587 MW) – NEON ENERGY company
 - Alb Solar2 photovoltaic park (50 MW) – Infotelecom-Albsolar2 company
 - Shkumbini Solar photovoltaic park (27.5 MWp) – HSD ENERGY company
 - Zalli i Shkumbinit photovoltaic park (20.96 MWp) – DOKO company
 - Tërfoja HPP (1.98 MW) – TËRFOJA HPP
 - Kulota HPP (1.53 MW) – KULOTA HPP
 - Sheq-Marinas photovoltaic park (40.56 MWp) – Albania Power Core company
 - Aeolian Dropull park (20 MW) – EU GREEN ENERGY company
 - Aeolian Lezha WEPP (54 MW) – AYEN RENEWABLE ENERGY

- KMV Aeolian Park (75 MW) – KMV company
- Orikum Aeolian Park (50 MW) – BRD ENERGY company
- Kryevindh Aeolian Park (75 MW) – VERBUND GPA company
- Floating TPP (130 MW) – KESH company

Plants that received the preliminary opinion regarding the transmission system during 2022:

- Voltex Solar Photovoltaic Park (2 MWp) – VOLTEX company
- Crypto Solar Solar Photovoltaic Park (2 MWp) – CRYPTO WORLD company
- ETMT Solar Photovoltaic Park (2 MWp) – ETMT company
- Pro Solar photovoltaic park (2 MWp) – ProBroker company
- Ener Solar photovoltaic park (2 MWp) – ENERTRADE company
- PMA Solar photovoltaic park (2 MWp) – Professional Marketing Albania company
- PROM Solar photovoltaic park (2 MWp) – PROM FB company
- Topojë photovoltaic park (12 MWp) – KATOBETA company
- InTex Solar photovoltaic park (28 MWp) – InTex company
- AG Solar photovoltaic park (28 MWp) – AG HPOWER & CONSTRUCTION company
- Povelçë photovoltaic park (30 MWp) – VEKO company
- SOLAR ALB photovoltaic park (40 MWp) – ALB-BUILDING company
- Solgen2 photovoltaic park (88 MWp) – SOLGEN company
- MD photovoltaic park (80 MWp) – MD green energy company
- RENPOWER photovoltaic park (58.75 MWp) – REPOWER company
- Solar3 photovoltaic park (60.5 MWp) – Ren Solar company
- Zadeja Dam photovoltaic park (8.25 MWp) – KESH company
- Trebinjë photovoltaic park (30 MWp) – REJ company
- Gjadër SE photovoltaic park (55.94 MWp) – RAFAELO 2002 company
- Gjadër NW photovoltaic park (9.33 MWp) – RAFAELO 2002 company
- Belsh photovoltaic park (50 MWp) – KESH company
- Kirac photovoltaic park (30 MWp) – KIRAC OTOMASYON
- Fier photovoltaic park (50 MWp) – WIND STREAM company
- DH Solar Park photovoltaic park (70 MWp) – DH Solar Park company
- Murriz-Thanë photovoltaic park (70 MWp) – Seman Sunpower company
- Dofti photovoltaic park (20 MWp) – Seman Sunpower company
- Gjanç photovoltaic park (30 MWp) – Seman Sunpower company
- Nartë photovoltaic park (150 MWp) – EDIL-AL-IT company
- ASL Solar photovoltaic park (11 MWp) – ASL SOLAR ENERGY company
- SUNRAY Solar photovoltaic park (55 MWp) – SUNRAY ENERGY company
- AUROUS photovoltaic park (55 MWp) – AUROUS ENERGY company
- FGZ Solar Energy photovoltaic park (100 MWp) – AD-STAR company
- Fortis photovoltaic park (19.77 MWp) – Fortis Energy and Construction company
- Akerni photovoltaic park (300 MWp) – SOLAR ENERGY CELLS company
- Lubonjë photovoltaic park (200 MWp) – HELIOS GREEN ENERGY company

- Fortis Ersekë photovoltaic park (62 MWp) – Fortis Energy and Construction company
- Titan photovoltaic park (6.013 MWp) – ANTEA Cement company
- Sunlight E&E photovoltaic park (42 MWp) – Sunlight E&E company
- Sunny Hill photovoltaic park (55 MWp) – Sunny Hill company
- Agro Iliria Solar photovoltaic park (78.5 MWp) – Agro Iliria Solar company
- BER hybrid photovoltaic park (30 MWp) – AEE company
- Belsh photovoltaic park (100 MWp) – VERBUND GPA company
- PVPP S.G. ENTERPRISE photovoltaic park (22.587 MWp) – S.G. ENTERPRISE company
- DCS Energy photovoltaic park (39.42 MWp) – DEUTHCOLOR company
- Belsh photovoltaic park (30 MWp) – LUEM TRADE and Construction company
- Enersol Power photovoltaic park (21 MWp) – ENERSOL POWER company
- Apollo Green photovoltaic park (40 MWp) – APOLLO GREEN ENERGY company
- Greenfarm&Energy Solar photovoltaic park (21.222 MWp) - Greenfarm&Energy company
- TeknoFire photovoltaic park (32.19 MWp) – TEKNOFIRE company
- Faethon photovoltaic park (93 MWp) – FAETHON company
- Osojë photovoltaic park (9.95 MWp) – BAD company
- Murati photovoltaic park (11.5 MWp) – GERTI company
- Aksa Solar photovoltaic park (40 MWp) – AKSA SOLAR company
- 3FAM photovoltaic park (27.5 MWp) – 3FAM ENERGY company
- Topojë photovoltaic park (55 MWp) – VERBUND GPA company
- Gjirokastër photovoltaic park (50 MWp) – 21 Construction company
- Lala Solar photovoltaic park (39.42 MWp) – GREEN ENERGY GENERATION company
- Golik photovoltaic park (8 MWp) – ALBGREEN POWER company
- Prrenjas photovoltaic park (20 MWp) – SURYA RENEWABLE ENERGY company
- Bushtricë photovoltaic park (20 MWp) – BESNIKU company
- 3G-Sun photovoltaic park (70 MWp) – Pelikani company
- Mallakastër photovoltaic park (65 MWp) – SHPRESA-AL company
- Himara Solar Farm photovoltaic park (100 MWp) – R&T company
- Devolli Sun 1&2 photovoltaic park (10.5 MWp) – DEVOLLI SUN POWER company
- Shashicë photovoltaic park (42 MW) – SOLAR NT company
- Devoll Aeolian Park (450 MW) – RENX ALBANIA company
- Korçë Aeolian Park (190 MW) – RENX ALBANIA company
- Pogradec Aeolian park (120 MW) – RENX ALBANIA company
- Pogradec 2 Aeolian Park (280 MW) – RENX ALBANIA company
- Ersekë Aeolian Park (200 MW) – RENX ALBANIA company
- Kalimash Aeolian park (50 MW) – WIND STREAM company
- F. Arrëz WEPP aeolian park (138 MW) – AYEN RENEWABLE ENERGY company
- Erseka Wind aeolian park (100 MW) – Ren Solar company
- Kaninë aeolian park (50 MW) – WIND STREAM company
- ERA Milot aeolian park (35 MW) – ERA MILOT company
- Qerret Pukë aeolian park (24 MW) – WIND STREAM company

- Roskovec CCPP TPP (180 MW) – FIER THERMOELECTRIC company

For the January - December 2022 period is set into operation one generation resource, the photovoltaic plant connected to the 10-kV transmission network. The Photovoltaic Plant on Qyrsaq dam (5.14 MWp), regarding the 220/110/10 kV Vau Deja.

Investment provision, for the future 5 (five) years, that TSO company or any other party plans to realize regarding the increase of cross-border interconnection capacity.

The principles of capacities restriction management at the existing and planned lines of the transmission system

Management of Limited Capacity deal with barriers of energy exchange, which are mainly caused by the limited capacity of the interconnection network, which means not only the interconnectors (cross-border lines), but every element of the internal network that is the reason for limiting transactions or transmission of energy from one area to another.

The safety of the work of the Power System is closely related to the assessment and determination of the transmission capacity. During 2022 period, in the transmission system, it is achieved the fulfillment of the safety criterion N-1, mainly for all work regimes, and no problems of limitation of transmission capacities have been encountered, with the exception of some sporadic cases, appearing in the 110kV network. as a result of the distribution of generation and consumption in the network.

The determination of cross-border transmission capacity, NTC, is currently made according to bilateral Agreements, which were signed between the TSO company and neighboring TSOs, and is based on the SAFA agreement (Synchronous Area Framework Agreement for Continental Europe), and its Annexes. For 2022, the cross-border transmission capacity, has been sufficient for the realization of import, export contracts as well as for the realization of the transits according to respective transmission capacities.

Borders	Import (MW)		Export (MW)	
	Maximum values	Minimum Values	Maximum values	Minimum values
Albania – MonteNegro	300	250	300	250
Albania – Greece	400	250	400	250
Albania – Kosovo	400	250	400	250

Figure 38 Max and Min values of Import and Export to the transmission capacities

Allocation of cross-border capacities for the market participants in our region, becomes from the Coordinated Auction Office SEE CAO in Podgorica.

Expected models of production, supply, cross border exchanges and consumption and taking the measures to manage the request for electricity

As presented above, it is performed the provision of electricity demand, to cover its losses through domestic production and the imports for the 5 next years, 2023 – 2027. This provision is realized according to the historical data for the last ten years, considering the average daily consumption for each month, shall be calculated the average gradient for the increase of electricity demand that is transmitted through the DSO network and the customers connected to the transmission network for each year.

The way to cover the expected demand is based on many years of experience, taking into account the flows in the cascade with 75% certainty, the level (expected one) of Fierza lake at the beginning of the year, the potential increase in the number and volume of generation of PVEs and PPEs, the possible export on their part depending on the conditions of the internal energy market and the energy import made by FTL (OSHEE) and qualified consumers, considering the possible increase of their number and the request for energy taking care to the optimization of Drini cascade.

The energy import to cover the losses at the distribution network, is calculated in a complementary way with the selected probability of production from the country's hydropower plants. The change in the annual quantity of import that may be dictated from the amendment in production of the country, as a result of the changes of the hydro situation, as the experience so far has shown, does not change the planning of the electricity demand.

The expected models of production, supply, cross-border exchanges and consumption, enabling the taken of the measures to manage the demand, are grouped in the following table.

Year	2023	2024	2025	2026	2027
Generation [GWh]	5954	6040	6125	6235	6335
Exchange [GWh]	2046	2045	2040	2010	1995
Consumption [GWh]	8000	8085	8165	8245	8330

Figure 39 NTC expected Models of production, inter-border exchange and consumption

The objectives for a sustainable development of the transmission network in national, regional and European level

TSO conducts continuous studies for specific areas of the transmission network as well as the Albanian Power System connection with the systems of neighbouring countries. The most important studies of a special importance are carried out in cooperation with international research institutions within WBIF (Western Balkans Infrastructure Facility). Such as the Master Plan for the development of electricity Transmission.

During the planning stages of developing the transmission network aiming the: (i) Rehabilitation and Strengthening of the transmission network; (ii) Establishment of new connection nodes; (iii) improvement of the management, control, measuring process etc, TSO company takes into consideration the national and regional development in full conformity with ENTSO-E directives (European Network of the Transmission System Operators for Electricity).

All projects in the process of implementation and those planned targets the increase of the quality of service for the transmission system, which may be fully performed only through the realization of the necessary investments for its strengthening and modernization.

Detailed information of the TSO company, regarding the investments provided for the interconnection line and the construction of internal lines of the network, which directly influence to the crossborder interconnection lines.

From the strategic point of view, the projects that strengthen the interconnection lines with the region, by establishing better conditions for commercial exchanges and no limit electricity transits in the European Southeast region are:

The construction of the interconnection 400 kV line, Elbasan 2 (Albania) – Bitola (North Macedonia) and Elbasan 2 – Fier as well as the extension of the Elbasan 2 and Fier substations.

Financing of this project shall be provided by the German-Albanian Development Cooperation.

This project strengthens the interconnections with the regional electricity network, establishing the conditions for commercial exchanges and transit without restriction of electricity in the region, develops the 400-kV network in the Southern area of Albania where future sources of electricity production are planned to be developed that shall be part of the infrastructure of the Eighth European Corridor, established good opportunities through the underwater cable with Italy.

This project includes:

- Construction of a new 400 kV transmission line with one circuit, to implement a bi-national connection between Albania and North Macedonia and to strengthen the existing transmission connection 220 kV that is over-loaded and old between Elbasan and Fier. The track of Elbasan – Bitola line shall have a length of about 56 km while the line Elbasan – Fier approximately 74 km.

The construction of the new substation Elbasan 3 and the strengthening and extension of the existing Fier substation. The new Elbasan 3 substation shall extent the existing 400/220 kV Elbasan 2 substation, with a plant in 400 kV level to be connected with Tirana 2, Zemblak, Fier and North Macedonia lines as well as the installation of a shunt reactor. Also, Fier substation shall be extended and be equipped with 400/200 kV transformers and a plant to the 400-kV level to permit the 400-kV connection to Elbasan 3.

Reconstruction of the 220kV interconnection line Vau i Dejës (Albania) – Podgorica (Mali i Zi)

The construction of the HVDC cable between Italy and Montenegro shall enable the evacuation of the future generation surpluses in the Balkan area and at the same time it shall further strengthen the transmission network in the region.

A series of new incentives for the construction of renewable energy plants are under development in the north of Albania and therefore reinforcements of existing interconnection lines are required to ensure cross - border exchanges between Albania and Montenegro.

The main purpose of this project is the increase of the transmission capacity of this line. The current line is constructed on 1972 with a low transmission capacity about 278 MVA but after the reconstruction it is expected that the capacity shall be significantly increased through the set of conductors of the latest technology HTLS (High Temperature, Low Sag) conductors.

The advantages obtained from making this investment are:

- increasing the security and reliability of the Albanian and Montenegrin network;
- increasing cross-border exchange between the two countries;
- increase of net Transfer Capacities between Albania and Montenegro, considering the electricity exchanges between Albania, Montenegro and Italy;
- reduction of network congestion;
- improving the quality of electricity supply;
- decrease of the technical losses;
- reduction of CO₂ levels;

Construction of the new 110 kV line Ulqin (Monte Negro) -Velipojë (Albania)

The construction of 110 kV line Border – Velipojë is part of the new line that is shall be constructed and shall connect Ulqin (Monte Negro) substation with the substation of new Velipoja (Albania). The DSO company on its mid-term plans provides the construction of the new substation in Velipoje with 110/35/20kV voltage with transformer capacity 2x20/25MVA. 110 kV line shall be constructed with a length of approximately 27 km that includes the line from the border to Velipoja substation, to continue with the installation of the second circuit with ACSR-240m² conductor, to Bushat substation.

This segment is part of the new line Ulqin (Monte Negro) – Velipojë (Albania) 110 kV line, which shall continue with the existing line Velipojë – Bushat, where shall be executed even the connection of this line. Part of the Velipojë – Bushat substation line that is spread at the Albanian territory is a pillar constructed segment, for the 110kV network, that enables the practic opportunity of its utilization and on this case enables to continue with the second circuit with all its elements for the 110-kV voltage level from Velipoja to Bushat substation. As above mentioned shall be considered a cooperation between two operators of both countries Albania and Monte-Negro for the construction of this line, with a proportional engagement.

Ulqin and Velipoja areas are two areas with highest touristic potential, and the provision of the electricity infrastructure shall guarantee further touristic maintenance and development of these areas.

Furthermore, this intervention shall stimulate new investments in hotels and tourist infrastructure, while increasing the number of small and medium-sized businesses, thus revitalizing the local economy towards enhancing agricultural and livestock production, etc.

The implementation of this project shall, among other things, ensure the fulfillment of the static security condition for the n-1 criterion, initially for Ulqin, and in a second phase, with the expansion of the Velipoja Substation, also the introduction in the ring of this Substation

The construction of a new air line 110 kV between Albania (Bajram Curri Substation) and Kosovo (Decan substation)

This project is as the result of memoranda agreements signed between Kosovo and Albania government in energy area as well as under the cooperation between two transmission companies TSO and KOSTT as a continuation and multiplanning process in operation to comply with the operational duties that these operators cover, the effective bilateral agreements and the obligations deriving from the common association at regional initiatives and not only.

TSO in cooperation with the Transmission Operator of Kosovo KOSTT finalized the first feasibility studies for the construction of the new interconnection line at the 110-kV voltage level connecting in the ring form the substations in the northeast area of the country to the areas with greater consumption of Kosovo such as Decan, Prizren etc.

On this way shall be utilized the diversification fact of energy production when it is informed that Kosovo relies on line production.

In this way, the fact of diversifying energy production shall be utilized, considering that Kosovo relies heavily on line-based production. Potentially, this shall bring about possible cost reductions in production from generators of both countries and the purchase of losses from transmission system operators at a lower cost. Diversification shall enable better management of ancillary services, effectively accommodating the imbalance that will arise from the addition of renewable resources.

This project shall also:

Increase the security and quality of electricity supply by reducing not only the disconnection hours of household customers but even the electricity non-transmission hours from the generators

improvement of voltage level

and reduction of losses.

The new 110kV line shall be with conductors on 240 mm² session with a total length of about 33km, 14 km on the Albanian territory and 19 km that passes on Kosovo territory.

Construction of the interconnection 400 kV line Elbasan 2 (Albania) – Bitola (North Macedonia) and Elbasan 2 – Fier as well as the extension of the Elbasan 2 and Fier substations

Financing of this project shall be provided by the German-Albanian Development Cooperation.

This project strengthens the interconnections with the regional electricity network, establishing the conditions for commercial exchanges and transit without restriction of electricity in the region, develops the 400-kV network in the Southern area of Albania where future sources of electricity generation are planned to be developed and as part of the Eighth European Corridor infrastructure, establishes good opportunities for connection for the underwater cable with Italy.

This project includes:

Construction of a new 400 kV transmission line with one circuit, to implement a binational connection between Albania and Northern Macedonia and to strengthen the existing 220 kV Elbasan – Fier transmission line. The track of the Elbasan-Bitola Line shall have a length of approximately 56 km while the Elbasan - Fier line shall be approximately 74 km.

Construction of the new substation Elbasan 3 and strengthening and expansion of the existing substation of Fier. The new Elbasan 3 substation shall expand the existing 400/220 kV substation Elbasan 2, with a Plant in 400 kV level to connect the lines Tirana 2, Zëmlak, Fier and Northern Macedonia as well as the installation of a reactor shunt. Also, Fier substation shall be expanded and equipped with 400/220 kV transformers and a plant at the level of 400 kV to enable the connection of 400 kV to Elbasan 3.

The reconstruction of the interconnection line 220 kV Vau i Dejës (Albania) – Podgoricë (Monte Negro)

The construction of the HVDC cable between Italy and Montenegro shall enable the sale of the future generation surpluses in the Balkan area and at the same time it shall further strengthen the transmission network in the region.

A series of new incentives for the construction of renewable energy plants are under development in the north of Albania and therefore reinforcements of existing interconnection lines are required to ensure cross-border exchanges between Albania and Montenegro.

The current interconnection airline Vau i Dejës (Albania) - Podgorica (Montenegro) was built in 1972 and has a transmitting power capacity of about 278 MVA.

The project includes:

- Reconstruction of the 220-kV airline Vau i Dejes - Koplik (AL) - Podgorica with a new dual circuit airline, approximately 45 km long with 490/65 mm² aluminum-steel conductors.
- The advantages obtained from making this investment are:
- Increasing the security and reliability of the Albanian and Montenegrin network;
- Increasing cross-border exchange between the two countries;
- Increase of Net Transfer Capacities between Albania and Montenegro, considering the electricity exchanges between Albania, Montenegro and Italy, under the security exchanges
- Reduction of network congestion;
- Improving the quality of electricity supply;
- Decrease of the technical losses;
- Reduction of CO₂ levels;

The construction of the new 110 kV line Ulqin (Monte Negro) -Velipojë (Albania)

The construction of 110 kV line Border – Velipojë is part of the new line that is conceived to be build and shall connect Ulqin (Monte Negro) substation with the new Velipoja (Albania) substation.

This segment is part of the new line Ulqin (Monte Negro) – Velipojë (Albania) 110 kV line, which shall continue with the existing line Velipojë – Bushat, where shall be executed even the connection of this line. Part of the Velipojë – Bushat substation line that is spread at the Albanian territory is a pillar constructed segment, for the 110-kV network, that enables the practic opportunity of its utilization and on this case enables to continue with the second circuit with all its elements for the 110-kV voltage level from Velipoja to Bushat substation. As above mentioned shall be considered a cooperation between two operators of both countries Albania and Monte-Negro for the construction of this line, with a proportional engagement.

Regarding the above, shall be considered a cooperation between both operators, of Albania and Monte Negro for the construction of this power line with proportional engagement.

Ulqini and Velipoja are two areas with great touristic potential and the provision of energy infrastructure shall guarantee the maintenance and further tourist development of the areas in question.

Also, this intervention shall stimulate new investments in hotels and tourism infrastructure, and shall increase the number of small and medium-sized businesses, thus revitalizing the local economy towards increased agricultural and livestock production, among others. The Ulqin, Bushat, and Velipojë areas also have potential for the development of renewable resources, mainly from wind.

From the engineering connection that shall be constructed, this shall be a new 110 kV line, with a length from the border to Velipoja substation of approximately 8 km, with ACSR-240mm² conductors.

The realization of this line among others shall bring the fulfillment of the condition for static security criteria for Ulqin but even for Velipoja substation operating as a ring.

The construction of this new 110 kV air line between Albania and Kosovo.

Considering the high hydro generating potential but even of other renewable resources, expected to connect with the northeast region of the country, there is ongoing study on the possibility of connecting this area of Albania (Bajram Curri and Kukës substations) to high-consumption areas in Kosovo such as Deçan, Dragash, Prizren, through a 110-kV interconnection ring line.

In this way shall be utilized the diversification fact of electricity production where it is acknowledged that Kosovo is based on the production with the lines.

Potentially, this may lead to possible reduction of production costs by the generators of both countries and the purchase of losses by the transmission system operators at the lowest possible cost. Diversification shall enable better management of ancillary services, efficiently handling the balances that shall result from the addition of renewable resources.

This project shall also increase the security and quality of electricity supply reducing not only the interruption hours of household customers but even the hours of electricity non-transmission from the generators, improving voltage levels and reducing the losses.

Quality and level of the transmission network maintenance

During January-December 2022 period, TSO company continuously followed the realization of the planned operations (planned overhauls) and the issues, concerns and breakdowns that have been encountered during the operation of the transmission system by making the necessary interventions on a case by case basis, with the preventive measures avoiding the possible breakdowns or when this last one mentioned are present, it is performed the intervention for their elimination and the return of the scheme to normal status.

Despite the difficulties and the issues that are established, mainly in winter, TSO reported that for 2021 are carried out all the planned overhauls and are taken the measures to eliminate all breakdowns that occurred during this period.

The works for the maintenance of the transmission network realized from the TSO company specialists are classified into three categories:

- planned operations in accordance with the annual schedule of the overhauls
- operations at any time (not planned)
- operations for the elimination of the breakdowns displayed in the system.

These works are carried out from the specialists of the operational units in cooperation and support of the respective sector specialists at the central directory at TSO company.

The result of the operations carried out for the maintenance of the networks is given even from the indicators reflected on the following table, which are positive.

Name	Total disconnections	Transitory	Stable	Atmosphere conditions	Defects of the line	Primary equipments	Secondary equipments	SHAM SHAF	Other OSHEE	Differents	Duration
400kV Line	10	7	3	3	0	0	5	0	0	2	0h
220kV line	66	50	16	26	11	1	21	0	0	7	60h9m
110kV line	477	394	83	112	33	18	293	8	5	8	268h34m
Lines in Total	553	451	102	141	44	19	319	8	5	17	

Figure 40 Problems to the transmission system

Measures applied by TSO company for peak demand management and interruptions in electricity supply as well as measures taken to increase security of supply if needed.

The measures to manage the request on peak hours and the supply interruption, as well as the other measures if needed to maintain the work security of the System, that are undertaken from the TSO to maintain the operational security, have as their main objective the comply of (N – 1) criteria to maintain the operational limits. Mainly they are categorized as pre-fault (preventive) or post-fault (corrective or curative) measures within the control area of the TSO (Transmission System Operator) or between interconnected TSOs.

The preventive improvement actions are normally implemented at the operational planning stage, to maintain the normal status of the system in the future operational situation and to prevent the spread of emergencies out of TSO responsibility area.

Preventive improvement actions may include, but are not limited to, the following:

Re-dispatch actions (of the aggregates) or the permission of trading in the opposite direction, when possible;

Amendments to the network topology;

Manual switching of reactive power devices (reactors, static capacitor banks, or the change of the set-point level of their controller;

Demands for additional support of reactive energy from the plants;

Correction remedial actions are the actions, which shall be immediately or relatively quickly after the emergency, which leads to a different state from the normal one. With the corrective actions the System is returned into normal status.

The correction remedial actions may include, but are not limited to as follows:

The re-dispatch or trade in the opposite direction actions, including the activation of TSO reserves;

The control of reactive energy equipments (reactors, capitor banks etc);

The managemet of voltage by reactive energy generation/absorbtion from the plants,

Actions of protection systems schemes, ex, the change of the network topology, the limit of production or load, depending of the protection specifications.

Analysis of the lines disconnections for the 12 months of 2022

Name	Total	Transitory	Stable	Atmospheric	Line	Primary	Secondary	SHAM	Others	Differentiation	Duration
	disconnection			Conditions	problems	Equipments	Equipments	SHAF	OSHEE	s	
400kV Line	10	7	3	3	0	0	5	0	0	2	0h
220kV Line	66	50	16	26	11	1	21	0	0	7	60h9m
110kV Line	477	394	83	112	33	18	293	8	5	8	268h34m
Lines in total	553	451	102	141	44	19	319	8	5	17	
Substations	Total	Transitory	Stable	Atmospheric	Fuel, gas	Primary	Secondary	SHAM	OSHEE	Differents	Duration
	Disconnection			Conditions	problems	Equipments	Equipments	SHAF	Staff		
AUTO, TR, Equipments	44	36	8	4	0	0	32	0	5	3	10h33m

Figure 41 Data on the transmission lines disconnections for 2022

Mainly the disconnection of the 110-kV line, that occur during the winter period, are transitory disconnections which are as result of the nodle overloads 110 kV and at the entry connection segments 110 kV and are re-switched within some minutes.

TSO defence plan in case of an emergency situation

In the framework of security increase of the supply and managing the electricity situation on the critical nodes of the system, for defined time-frames, mainly during summer and winter period, (during the end of the year holidays), the TSO took additional measures to confront the situations and to cooperate with the DSO for an efficient Operation in the framework of maintaining the Stability and Safety of the System.

The undertaken additional measures consist in:

Action plan according to the submitted situations.

The held of the joint working groups with the Distribution System Operator of Electricity.

Detailed analysis of loading the transmission network of the Regions defined as criteria.

Analysis and prioritization of operational actions for normal operation and potential line or autotransformer dis-connection based on the handled case as the most problematic.

Continuously maintaining into readiness status of the connections and the overhauls TSO working group to enable the normalization of the supply schemes as quickly as possible, in case of disconnection of the lines in extended emergencies, or any other abnormality that affects the switching devices situation.

Promotion of responsible structures directly engaged into utilization, maintenance and operation of the system and the vigilance of being updated with the issues occurring to the TSO system.

Well-organized structures and increase of human capacities, if necessary, for the proper maintenance of the network during these periods.

Communication and continuous cooperation with the dispatch center of OSHEE company.

In normal operational conditions, Operational Safety means the ability to ensure normal operation of the System, to limit the duration and the number of disruptions, to prevent major disturbances and to limit the consequences, in the event of significant disruption.

The plan of protecting the System is important in the framework of receiving the immediate measures to normalize the status of the system and also to facilitate the System Reset after a black – out, to return the System into normal operation.

TSO defence plan in case of an emergency situation:

System defence plan is connected with an emergency situation, with the relevant process of information and improvement actions and is composed of a series of coordinated measures, which aim the maintenance of the System integrity, in case of the conditions that realize extreme disturbances. The TSO is on Emergency Situation if it has at least one deviation of the Operational Safety Limits and the times defined on Article 99 (Chapter I) of the Transmission Code and the operators have not improvement measures to reset the Normal Status of the System.

The system protection plan drafted by TSO company also summarizes all technical and organizational measures taken to prevent the spread or deterioration of an incident in the Transmission System, to avoid, expansion of the breakdown and the collapse of the System; the System Protection Plan, drafted by the TSO includes:

automatic over / under frequency control scheme

automatic control scheme from voltage collapse

the procedures followed during the activation of the protection plan as well as the conditions for the activation of remedial actions

System Protection Plan measures

System Protection Plan measures are presented as emergency remedial actions. As follows are given examples of the applicable measures of the System Protection Plan measures in cases of the load, frequency, energy and voltage flows.

restrictions of the load / frequency

release or closure of power generation units;

increasing or decreasing (automatically or on demand) of the production level of generating units;

adaptation of active LFC control mode;

manual or automatic use of reductions, load unloading;

changes in the operating points of transformer voltage regulators in the distribution level.

restrictions on electricity flows;

cancellation of the repairs of network elements and set them into work as soon as possible;

automatic disconnection of the unit (generator) that is activated by disconnecting a relevant transmission line;

trading in the opposite direction with neighboring areas of responsibility;

interruption of planned exchanges;

reduction of the exchange program;

reductions of the interconnection capacities;

manual unloading of facilities with interruption agreements;

automatic uploading of the facilities with agreements for interruption, caused from the disconnection of a transforming line;

further uploading of the load depending on the situation.

voltage restrictions

Request for minimum and maximum values of active and reactive load generation;

Reduction of active load in favour of additional production of reactive loading;

Prevention of the providing units, injection of additional reactive energy;

Maintenance suspension and activation of previously under maintenance elements;

The block of the voltage regulator's position at the regulation transformers under load.

Realized investments and those that are pending to be finalized, which contribute to the increase of the security of supply during 2022.

Also, in the framework of the supply safety increase to manage the situation of the power sector in the critical nodes of the system for defined time-periods, are the scheduled investments in the TSO network with the primary purpose the safety increase and quality of electricity supply.

For this purpose, during 2022 are finalized the investments as follows:

The postpone of the air line 220 kV double circuit Tirana 2 – Elbasan 2

Primary works, for the supply and the set up of the TR 63 MVA, 220/20 kV transformer, Tirana 1 substation, secondary works for the its adoption with the existing systems.

Reconstruction of the Ulëz – Burrel 110 kV line

At the end of this period terminated the energization of one of the most important investments with a local but even wider regional impact such as the energization of the shunt reactor on the 400kV side of Tirana 2 substation.

It is executed the intervention to the transmission line as well as of their tracks and it is made the substitution of the 120 mm to 240 mm conductors.

It terminated the Connections and their tracks: Fiber - Librazhd, Ulez- Burrel, as well as the construction of the new line 110 kV, with a Cerrik – Kajan – Kuçovë – Jagodinë circuit and the rehabilitation of the exit tracks of the 110 kV lines of Cërrik and Kuçovë substations that have an impact to improve the supply security.

Also, for the increase of the transmission safety it is worked in some Substations making possible the substitution of the Load transformers Rrashbull, Sharrë, 220 kV Tt1 substations.

The measures undertaken to guarantee the readiness and safety of the system within the operational limits, include the primary and secondary systems, as well as regarding cybersecurity and critical infrastructure.

a) The measures undertaken to guarantee the readiness of primary and secondary systems

Some of the measures undertaken from the TSO company in the framework of addressing the concerns, events or incidents to guarantee the readiness and security of the system within the operational limits including the primary and secondary systems, for 2022 are the realized investments.

The investments realized during 2022 in the transmission network are:

The construction of the substation 220/110/35 kV, the amount and the 220-kV track, in Komsî 220/110/10 kV, substation

The Supply and the Set of the Shunt Reactor 400 kV in Tirana 2 substation which shall significantly increase the security of supply and quality of performance of the system.

The construction of two circuit 110 kV Fibër-Librazhd connection and the tracks of the respective lines of Fibër e Librazhd substations.

The construction of the new line 110 kV, with one circuit Cerrik – Kajan – Kuçovë – Jagodinë and the rehabilitation of the exit tracks of the 110 kV lines of Cerrik dhe Kuçovë substations.

The primary works, the supply and the set of the TR 63 MVA, 220/20 kV Transformer, on Tirana 1 substations, secondary works for its adoption with the existing systems.

The constriction of the AT 110 MVA 220/110/35 kV base in Sharrë substation”.

The Civil Works for the trunks and the 110-kV connection at the Operational Unit

Reconstruction of the 110 kV Ulez-Burrel connection line

There are also at the implementation process with its own funds even the projects as follows

The new two circuit line 220 kV Komsî – Shumat

The civil works for the tracks and the 110-kV connection at the Operational Unit

110 kV Librazhd – Prrenjas line

The projects of the TSO with its own funds are approved during 2021÷ 2022 and is expected to initiate during 2023 period are:

Construction of the 110-kV line double circuit Elbasan – N Substation.

Fibër station the construction of the new 110 kV line double circuit Elbasan – Cerrik

The construction of the new 110 kV line, with single circuit Lushnje – Fier

The construction of the new line with two circuits 110 kV Burrel – Bulqizë and the rehabilitation of the 110 kV substations, Burrel and Bulqizë

The measures for cybersecurity and critical infrastructure

The TSO being part to the critical infrastructure continuously holds studies and drafts the plans to enable the prevention from different cyber attacks in our infrastructure.

Based on the strategy for preserving and enhancing the skills of users and specialists to detect, handle, report, and respond to incidents occurring in Information Systems during 2022, measures have been taken to achieve the objectives in security increase, where actions have been taken in implementing and managing the security systems such as:

Next generation Firewall central Antivirus

Jump server

Monitoring systems of the network,

Alert systems for any software installation and the amendment of the hardware

Patch management server for the update of operation safety systems.

TSO company was engaged in conducting a Practical Assessment of all the services as part of a General Assessment on Cyber Security and to receive the measures regarding them.

Specifically, below there are listed the measures taken to increase and improve cyber security.

The update of the ISMS system (Information security management system) according to ISO27001

where there are reviewed the set of policies, procedures, manual and the respective forms.

The isolation of the industrial network (SCADA) to the IT one

The update of the systems with the latest security systems

The review of all accesses in the system leaving only the necessary ones

Performance of the system penetration tests

Risk assessment for the weak points of the systems

Continuously are held the informative and training sessions with the staff to increase the awareness and inform regarding the importance of Cyber Security where are submitted the examples such as the attack email phishing attack techniques.

TSO company currently is developing some projects which affect in lowering the surface of the attacks as well as the reduce the risk of the attack.

Upgrade of central SCADA/EMS platform as well as their infrastructure (New next generation firewalls Central Endpoint security, Log management etc)

All communications with the adjecents pass to the private European network.

The establishment of the managing and monitoring platform for the L1 network of telecommunication.

During 2023 are provided the projects for the increase of cybersecurity as follows:

The establishment of SIEM platform to manage and analyse the logs in the IT network

Substation hardening

The establishment of SOC- security operation center

The establishment of a training and awareness platform for cybersecurity for all the staff

1.4 ELECTRICITY DISTRIBUTION

1.4.1 Activity of the Electricity Distribution System Operator (DSO company)

Electricity distribution in our country is performed by Distribution System Operator (DSO company), licensed by ERE according to the provisions of Law no. 43/2015 "On Power Sector" as amended. The Distribution System Operator owns the assets in the Electricity Distribution System, in order to deliver electricity to the customers. The limit of the distribution system with the transmission system is defined by Law no. 43/2015 "On Power Sector", as amended.

The Distribution System Operator (DSO) is responsible for ensuring the safe and sustainable development of the distribution system, the compliance of the requirements for electricity distribution, maintenance and safe operation of the electricity distribution system throughout the territory for which it is licensed. In accordance with the Law no. 43/2015 "On Power Sector", the

DSO shall procure electricity in the open market and from renewable sources, according to the regulation approved by ERE and through the electronic platform for electricity purchase procedures.

The Distribution System Operator (DSO company) is organized in 11 distribution areas and 42 agencies.

According to the data of DSO company, the total energy introduced in the distribution network for 2022 is **7,044,604 MWh**, from which **1,457,840 MWh** are the losses in the distribution network.

The table below are submitted the data on the main indicators of the Distribution System Operator DSO company during 2022 period.

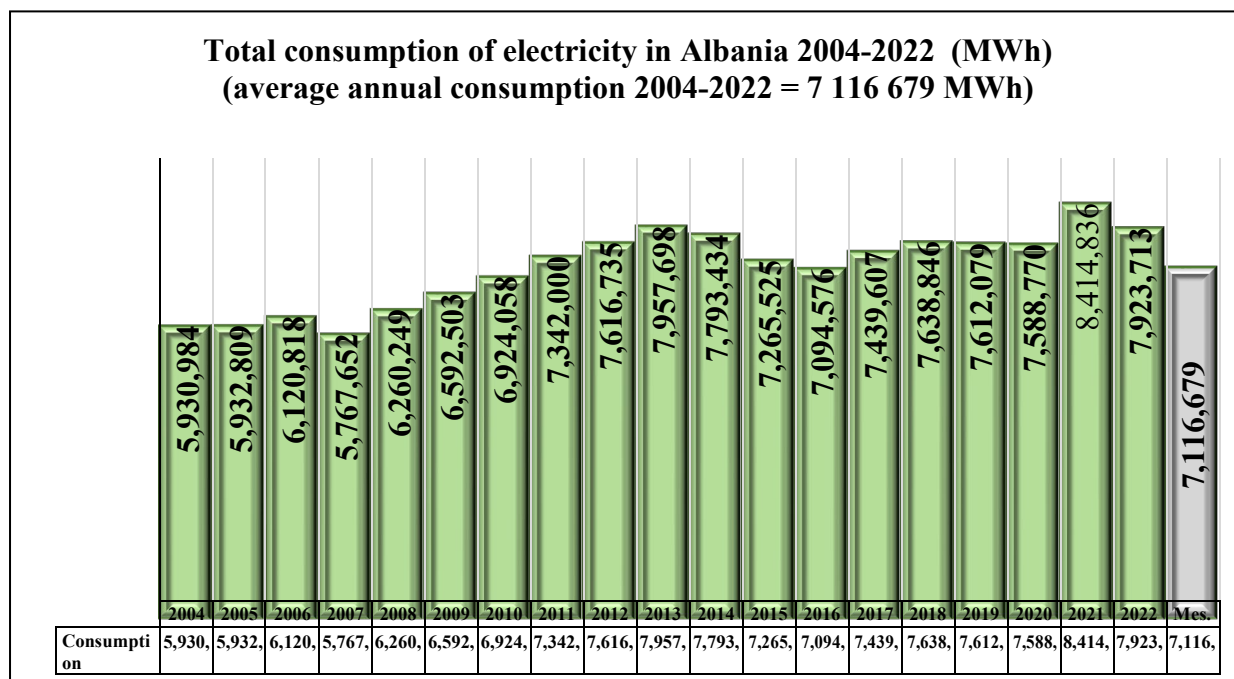

Figure 43 Total electricity consumption in the country throughout the years

As it can be seen in the graphic presentation, the lowest electricity consumption recorded in our country is in 2007 with 5,767,652 MWh and the highest electricity consumption is the one recorded in 2021 with 8,414,836 MWh, and this last one mentioned composes the highest historic consumption in our country. Compared to 2021 there is a slight decrease of electricity consumption in the country by 491,123 MWh.

The total decrease of electricity consumption for 2022, compared to 2021, is about 5.8 %. At the same time, the total electricity consumption realized for 2022 is about 11.3 % higher than the average consumption indicated on the table.

This decrease of the total energy consumption, is reflected for all customer's categories, but especially for the customers that are supplied in the irregulated market, which for 2021 period have consumed about 1,361 GWh of electricity, while for 2022 these customers have consumed about 929 GWh of electricity. This decrease of the consumption is due to the energy consumption caused from the war in Ukraine.

The total electricity consumption in the country during 2022 is covered from electricity generation realized from KESH company, independent producers of electricity, electricity priority producers, as well as from the electricity import.

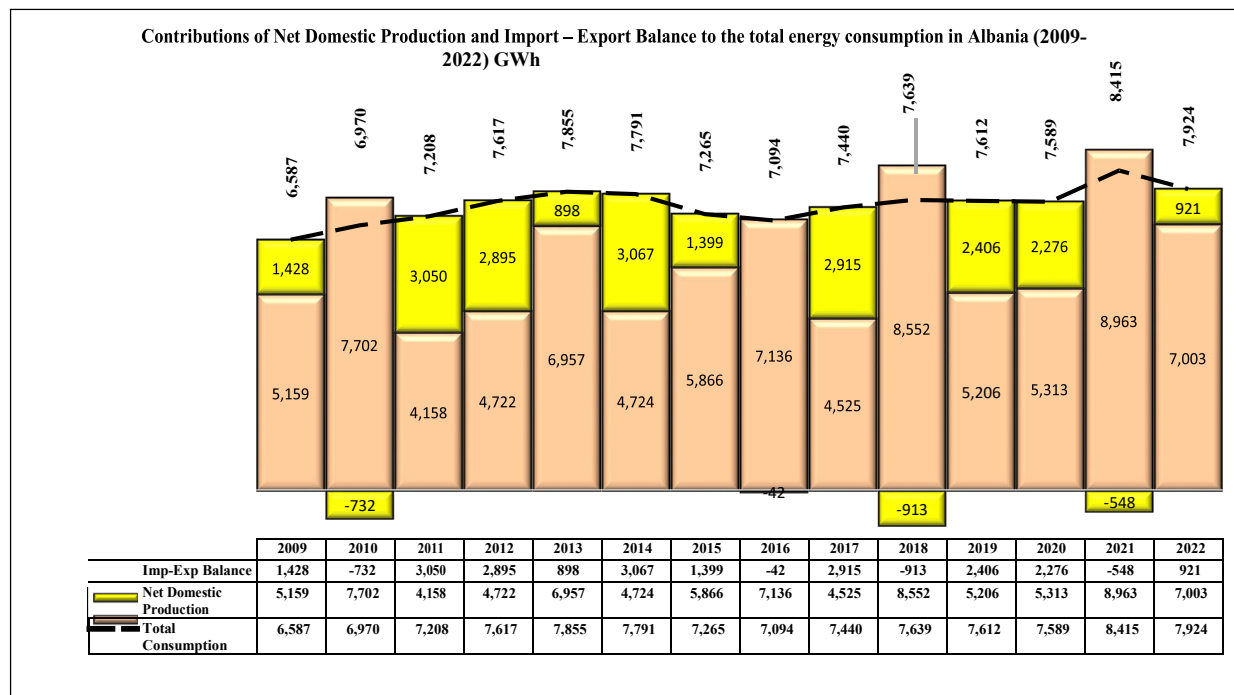

Figure 44 Net domestic production contributions and the import-export total consumption of electricity in Albania

On the table above, it is evidenced the net domestic production and the import – export balance. As submitted on the above data, the domestic net production for 2022 results to be 7,003 GWh, while the total consumption of the country results to be 8,415 GWh, with a net balance to the import 921 GWh.

Net balance of electricity exchange for 2022 period of about 548 GWh, resulted as a difference of the export realized on the quantity of about 2,123 GWh and the realized import is realized on 3,044 GWh value. This is due to the fact that the Albanian power system bases the electricity production on hydro resources, where for rainy periods may export electricity and for dry periods during the year, realizes the electricity import to cover the demands in the country, in other words, the production profile of the country do not always correspond for the same period with the consumption profile in our country, that shall contribute positively for the diversification of the electricity generation resources.

Contributors to cover consumption for 2022				Contributors in Electricity Consumption Provided for 2022				
How Used Electricity is provided				Where provided energy is consumed				
Public production (KESH)	Priority producers	Producers to Open Market	Balance to Interconnection	Consumption to the regulated market (sales +losses)	Consumed from the Customers in HV ("qualified")	Consumed from the customers connected to 35kv	Consumed from TSO (losses +personal needs)	Consumed withFTL suppliers
3,859,730	1,983,818	1,159,097	921,006	6,994,205	678,843	18,207	199,994	32,402
		7,923,651	hyrje			7,923,651		

Contributors to cover consumption for 2021				Contributors to Electricity Consumption Provided for 2021				
How Used Electricity in Provided 2021)				Where shall be consumed the provided electricity 2021				
Public Production (KESH)	Priority producers	Producers to the Open Market	Balance to Interconnection	Consumption in the regulated market (sales +losses)	Consumption from HV Customers ("qualified")	Consumed from the Customers connected to the 35kv line	Consumed from TSO customers (Losses +personal needs)	Consumed with suppliers FTL
5,343,974	2,192,736	1,425,989	547,896	7,054,114	1,049,953	64,916	227,918	17,935
		8,414,803	dalje			8,414,836		

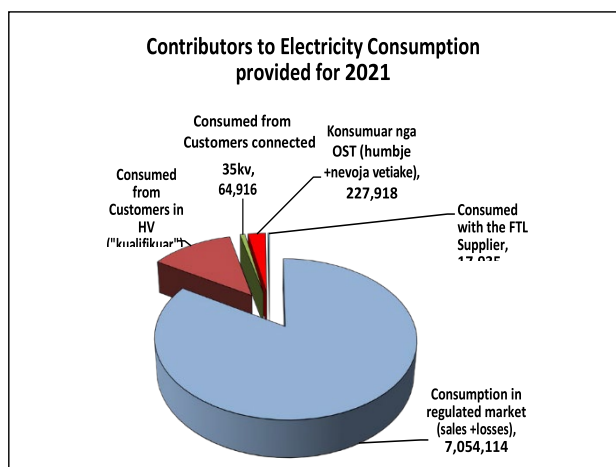
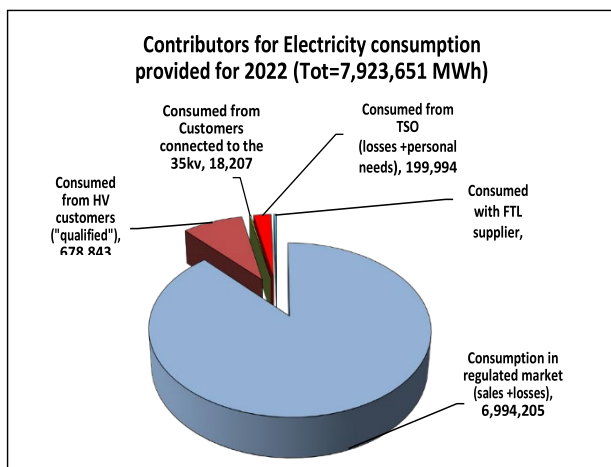
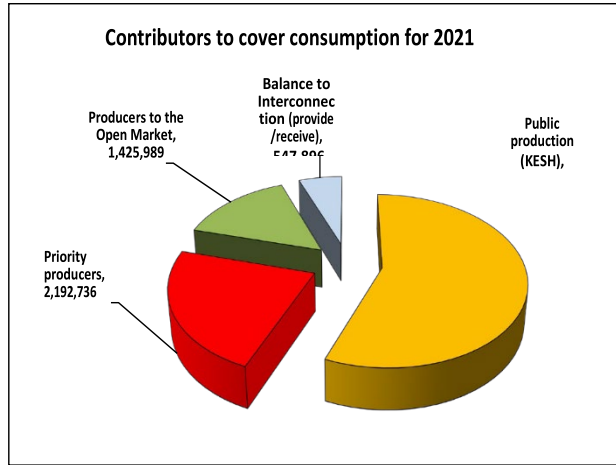
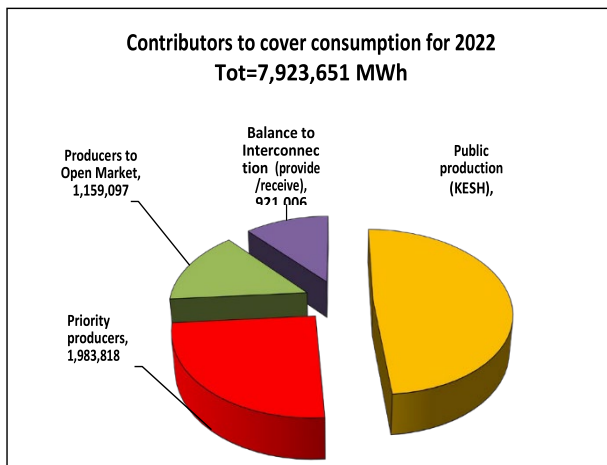

Figure 45 Components to cover electricity consumption provided for 2021 – 2022 period

1.4.3 Structure of electricity consumption

Distribution of customers according to regional directories and categories 2022						
Region	Household	Private	Budgetary	Non-Budgetary	Personal Consumption	TOTAL
Berat	89,559	14,476	1,001	380	6	105,422
Burrel	54,346	6,408	699	318	8	61,779
Durres	154,124	19,731	906	338	16	175,115
Elbasan	95,868	13,325	961	463	8	110,625
Fier	73,383	10,333	630	308	9	84,663
Gjirokaster	70,850	10,290	1,259	343	6	82,748
Korce	82,414	9,748	1,002	292	9	93,465
Kukes	18,846	2,344	337	96	4	21,627
Shkoder	101,532	14,444	965	64	14	117,019
Tirane	293,370	54,470	1,698	446	33	350,017
Vlore	74,832	11,218	587	217	5	86,859
Total (no)	1,109,124	166,787	10,045	3,265	118	1,289,339
Total (%)	86.0	12.9	0.8	0.3	0.01	100.0

Figure 46 Distribution of DSO customers according to the regions and categories during 2022

(Source: DSO company)

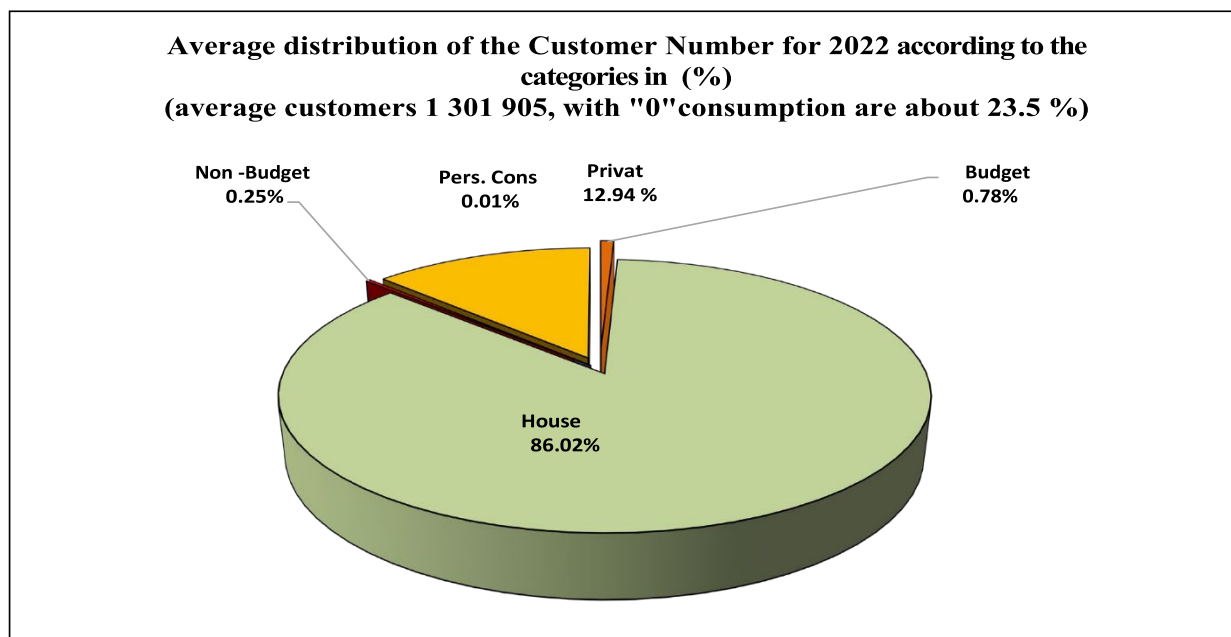

Figure 47 Distribution of customer number for 2022 according to the categories (%)

(Source: FSHU company)

The data submitted above for 2022 period show that the total number of the customers for 2022 is 1,301,905 and the biggest part of the FSHU customers for this year is occupied from household customers, that compose 86.02 % of the total number of FSHU company customers.

In the demographic distribution of FSHU customers even for 2022 period the biggest part is in Tirana, with about 22.7 % of all FSHU company customers.

The structure of FSHU company customers is reflected even on the electricity invoice structure realized for 2022 period. The household customers occupy the biggest part at FSHU company and the biggest part of the electricity invoiced for 2022 period, or 43.12 % of all of the invoice realized for 2022 period.

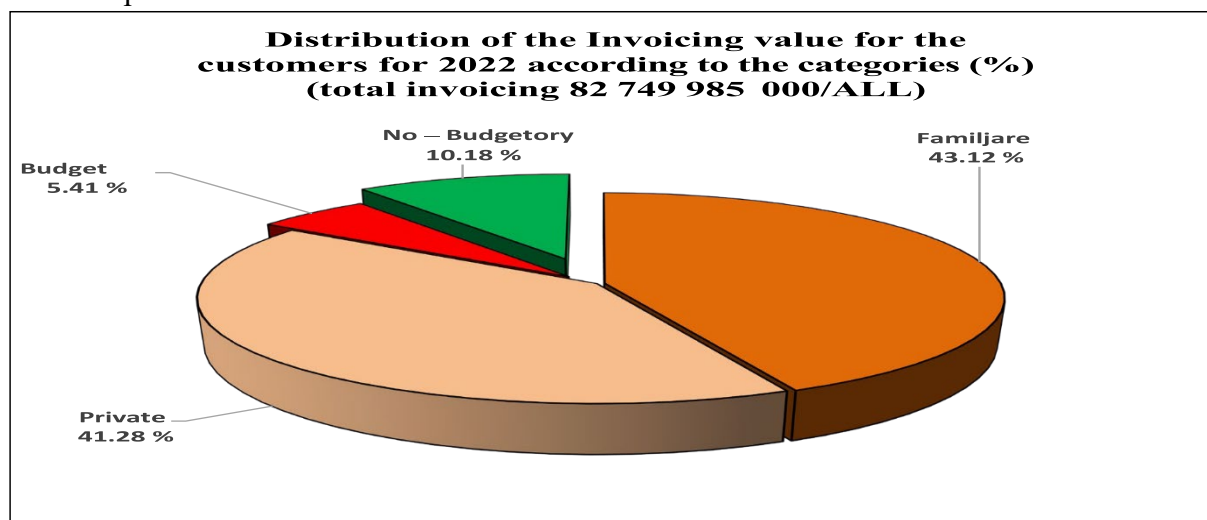

Figure 48 Invoicing raports according to customer categories during 2022 (Source: FSHU company)

On the following figure are submitted the specific weights of invoicing that are occupied by household customers categories.

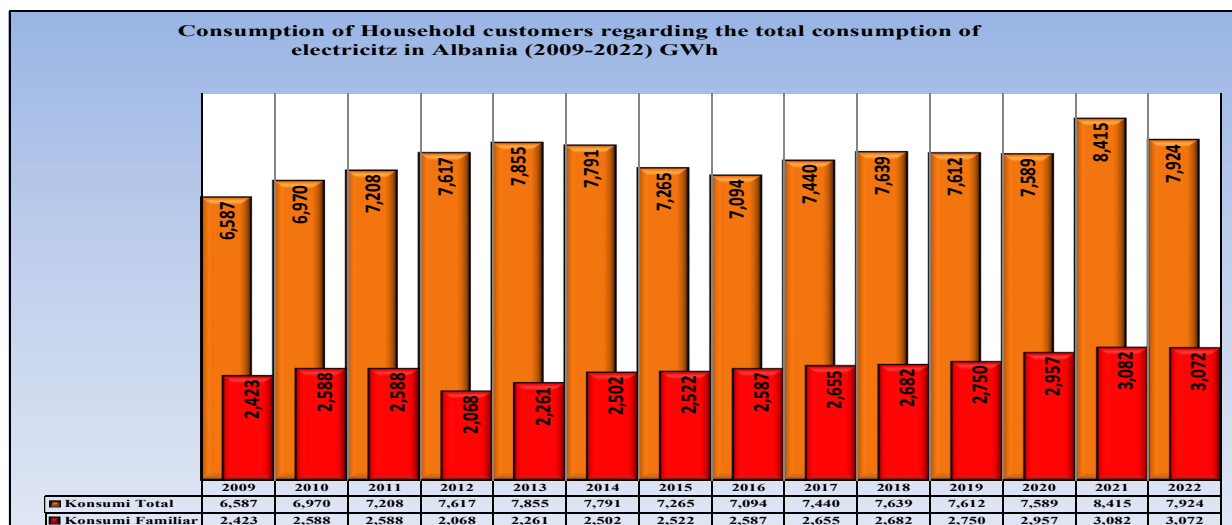

Figure 49 Household customers to total consumption of the countrz throughout the years

(Source: FSHU company)

Household customers consumption occupies about 38.8% of the total consumption, a number that is higher compared to the consumption for the same category for 2021 period, that was of about 36.6 %.

1.4.4 Electricity Consumption Profile

The annual profile of electricity consumption, is characterized from the almost complete symmetry of winter – summer consumption.

During 2022, as seen from the graph above resulted highest values than the average for January-August period and lower than the average for October – December period. The decrease during the end of the year is caused from the climatic conditions and the energy crisis.

As in the reports of previous years, during this year the same phenomenon is observed, that of using electricity for heating in winter, but even for the cooling systems in summer, elements that may lead to the symmetry of electricity consumption, for winter and for summer period. Any change of the environment temperature is immediately reflected in the daily consumption of electricity, precisely from the effect of using or not using the electricity cooling / heating of the building.

During the summer season, in July and August the peak tendency is increasing, which from year to year is becoming more evident and is related to climate changes, improving living conditions leading to the increasing use of air conditioning equipment during the hot months.

As follows are submitted the data of average daily consumption for each month of 2022, compared to the average data of 2009 – 2022 period.

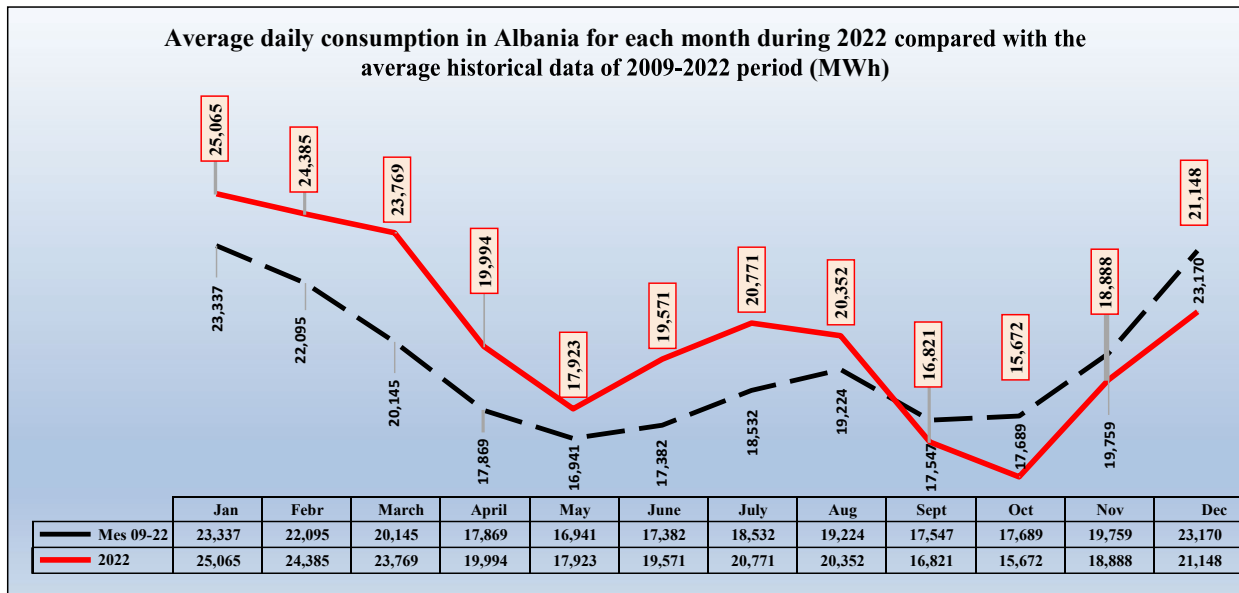

Figure 50 Average daily consumption for each month of 2022

On the following graph it is submitted the average daily profile on hourly basis of the load for 2022 period.

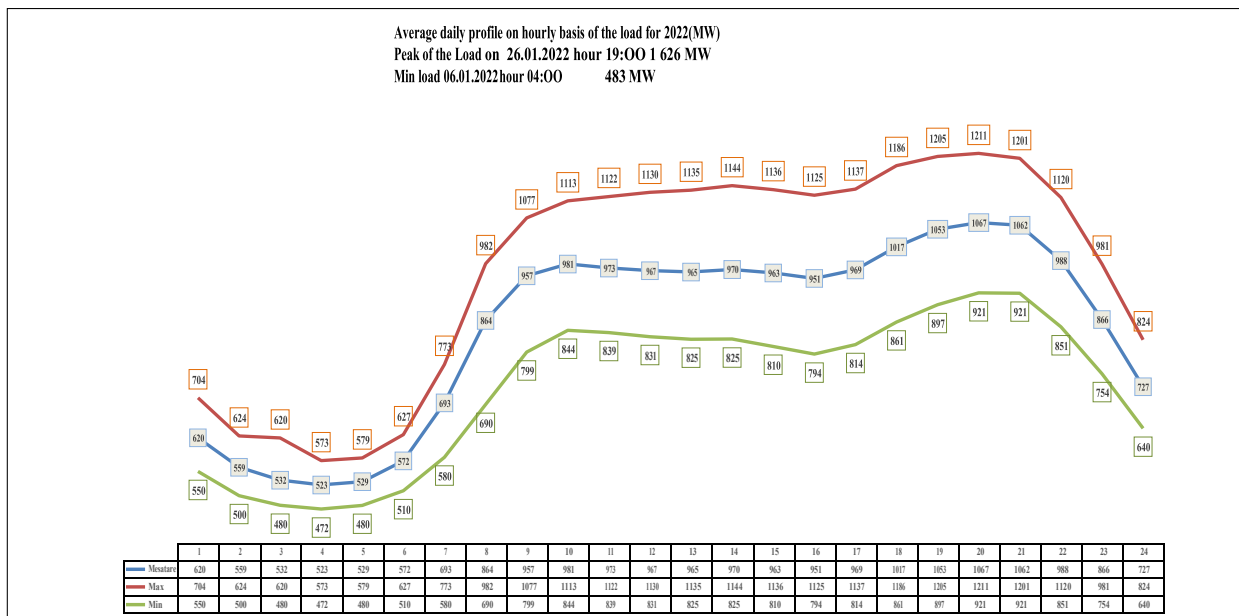

Figure 51 Average daily profile on hourly basis of the load for 2022

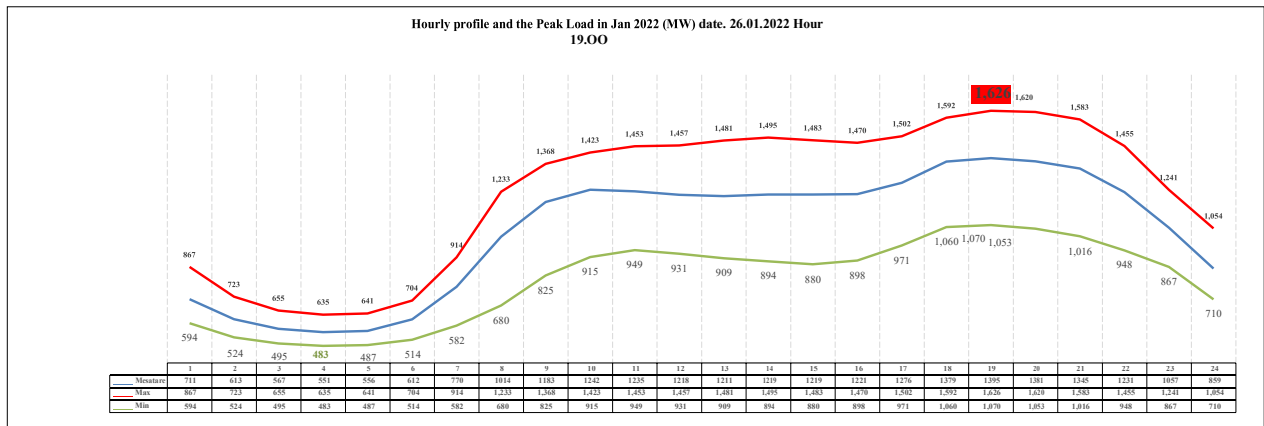

Figure 52 Profile and peak of the load on December 2022 (MW)

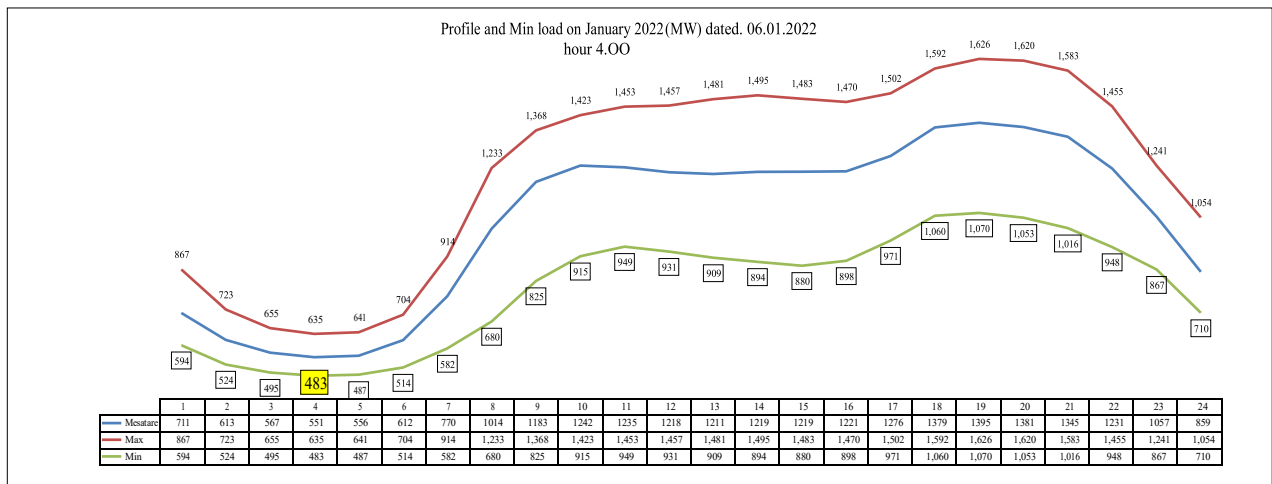

Figure 53 profile and minimum load on March 2022 (MW)

As notified on the above graphical submission, the peak of the load is on **26.01.2022, hour 19:00, of about 1626 MW**, while the minimum of the load is registered on **06.01.2022, hour 04:00, of about 483 MW**.

1.4.5 Indicators of electricity supplied, sold and lost for each area and agency of the Distribution Operator DSO company during 2022.

As follows are submitted the data regarding the indicators of the supplied, sold and lost electricity (in MWh), for each area and agency of the DSO company during 2022.

Regional Directory /Agency	Year 2022			
	Introduced Energy MW h	Sold energy MW h	Losses in MWh	Losses in %
Tirana1	961,551	835,100	126,451	13.2
Tirana2	876,635	767,419	109,216	12.5
Tirana3	675,797	587,796	88,001	13.0
Tirana Reg Dir	2,513,983	2,190,315	323,668	12.9
Durres	416,857	358,912	57,946	13.9
Kavaje	174,390	149,531	24,858	14.3
Kruje	171,728	122,956	48,772	28.4
Shijak	199,424	147,665	51,759	26.0
Durres Reg. Dir	962,399	779,064	183,335	19.0
Ballsh	44,889	37,797	7,091	15.8
Fier	346,446	304,768	41,678	12.0
Patos	67,988	54,419	13,569	20.0
Fier Reg. Dir	459,322	396,984	62,339	13.6
Elbasan	348,686	304,915	43,771	12.6
Gramsh	25,632	22,242	3,390	13.2
Librazhd	72,503	59,315	13,187	18.2
Peqin	43,612	34,780	8,832	20.3
Elbasan Reg. Dir	490,433	421,253	69,181	14.1
Bilisht	37,807	32,493	5,314	14.1
Kolonje	22,779	19,386	3,393	14.9
Korce	242,815	200,866	41,949	17.3
Pogradec	78,116	70,060	8,056	10.3
Korce Reg Dir	381,517	322,805	58,712	15.4
Delvine	16,784	14,278	2,506	14.9
Cjirrokaster	106,207	84,124	22,083	20.8
Permet	21,756	18,305	3,451	15.9
Saranda	126,417	107,088	19,329	15.3
Tepelene	31,219	21,121	10,098	32.3
Gjirokaster Reg Dir	302,383	244,916	57,467	19.0
Koplik	77,501	41,832	35,668	46.0
Lezhe	178,438	122,090	56,348	31.6
Puke	33,259	21,356	11,902	35.8
Shkoder	417,605	277,677	139,928	33.5
Shkoder Reg Dir	706,802	462,956	243,846	34.5
Berat	124,586	105,782	18,804	15.1
Kuçove	72,070	62,045	10,025	13.9
Lushnje	205,391	170,876	34,515	16.8
Skrapar	36,954	31,115	5,840	15.8
Berat Reg Dir	439,002	369,817	69,185	15.8
Has	34,006	17,978	16,028	47.1
Kukes	106,464	65,012	41,452	38.9
Tropoje	68,466	30,960	37,505	54.8
Kukes Reg Dir	208,935	113,950	94,985	45.5
Bulqize	51,681	43,521	8,160	15.8
Diber(Peshkopi)	84,448	56,623	27,825	32.9
Lac	214,352	149,089	65,262	30.4
Mat (Burrel)	61,200	45,412	15,787	25.8
Mirdite	60,806	47,536	13,269	21.8
Burrel Reg Dir	472,486	342,182	130,305	27.6
Himare	33,890	30,032	3,858	11.4
Selenice	46,205	21,157	25,049	54.2
Vlore	283,939	241,359	42,580	15.0
Vlore Reg Dir	364,034	292,548	71,487	19.6

Figure 54 Data on the main indicators for each agency of the Distribution System Operator DSO company during 2022

Even in the previous years, the highest losses belong to the Regional Directories of Tirana and Shkodra, while the lowest level of losses during 2022 were on the Regional Directories of Përmet, Gramsh and Himara. Even during the 2021 period, the highest losses of electricity were on the Regional Directories of Tirana and Shkodra, while the lowest level of the losses was also on Përmet, Gramsh and Himara.

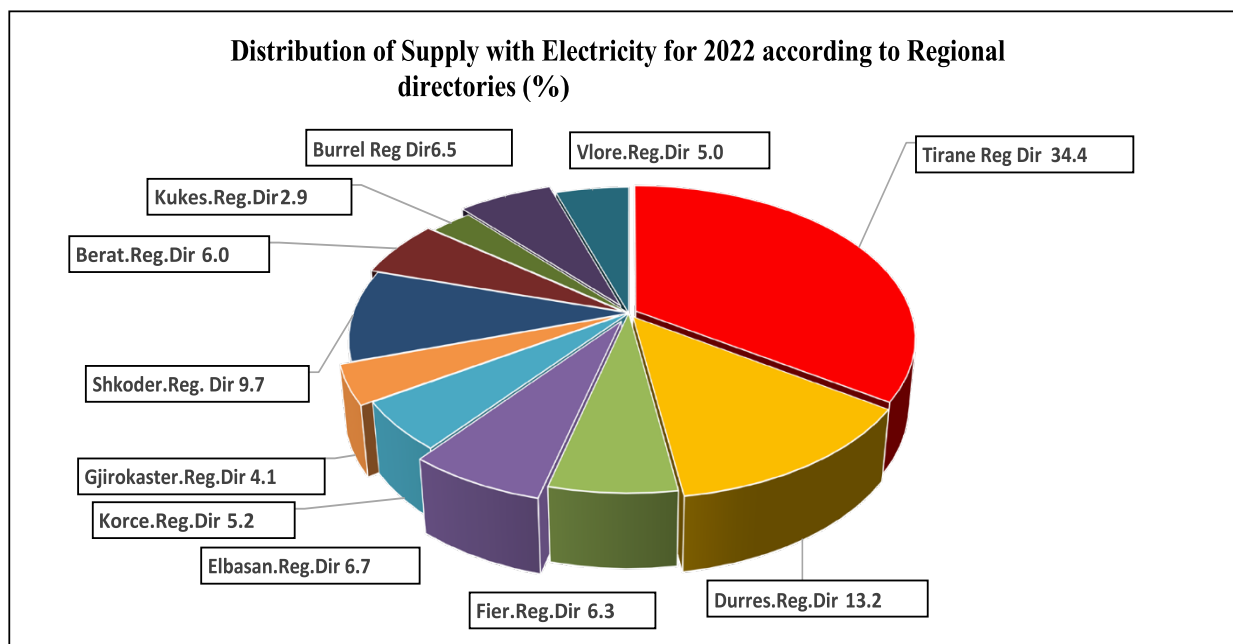

Figure 55 Distribution of supply with Electricity according to regional directories (%)

As evidenced even in the figure, the biggest part of electricity consumption in the country for 2022 is occupied by the Regional Directory of Tirana, while the lowest part is occupied by the Regional Directory of Kukes.

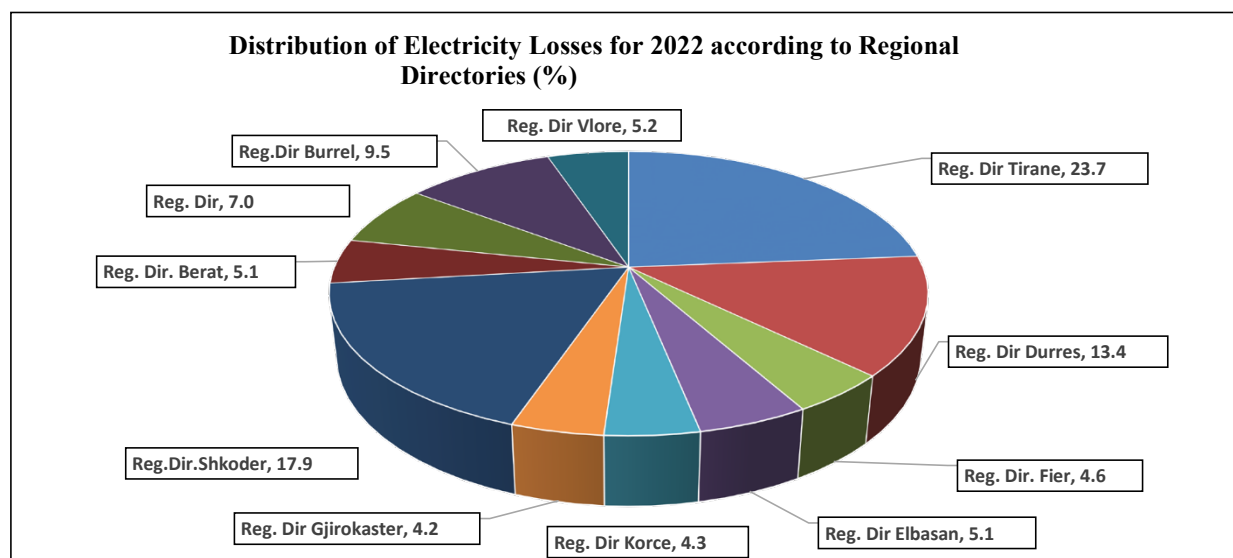

Figure 56 Distribution of electricity losses according to regional directories (%)

On the following table it is submitted the level of the losses in the distribution system, with the targets decided by Council of Minister Decision no. 758, dated 09.12.2021, “On an amendment on Council of Minister Decision no. 253, dated 24.04.2019, “On approving the financial consolidation plan of the electricity public sector”.

As evidenced, the electricity losses in the distribution system during 2022 period are 19.7 %, with a difference of about 0.1% from the target decided by Council of Minister Decision no. 758, dated 09.12.2021, “On an amendment on Council of Ministers Decision no. 253, dated 24.4.2019, “On approving the financial consolidation plan of the electricity public sector”.

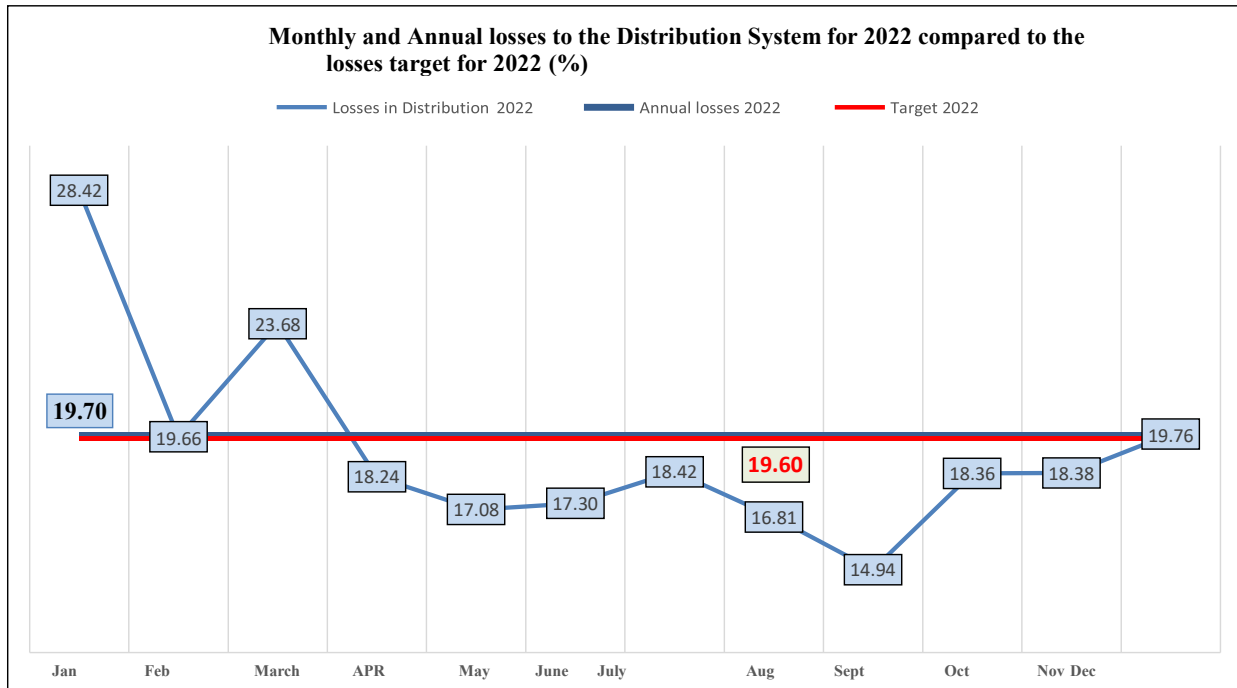

Figure 57 Annual /monthly losses to the distribution system, compared to the target of losses of electricity

Submission of the contribution in the respective supply and losses according to the agencies is shown in the following figure, on which it is evidenced the electricity quantity supplied for each agency and the respective electricity losses.

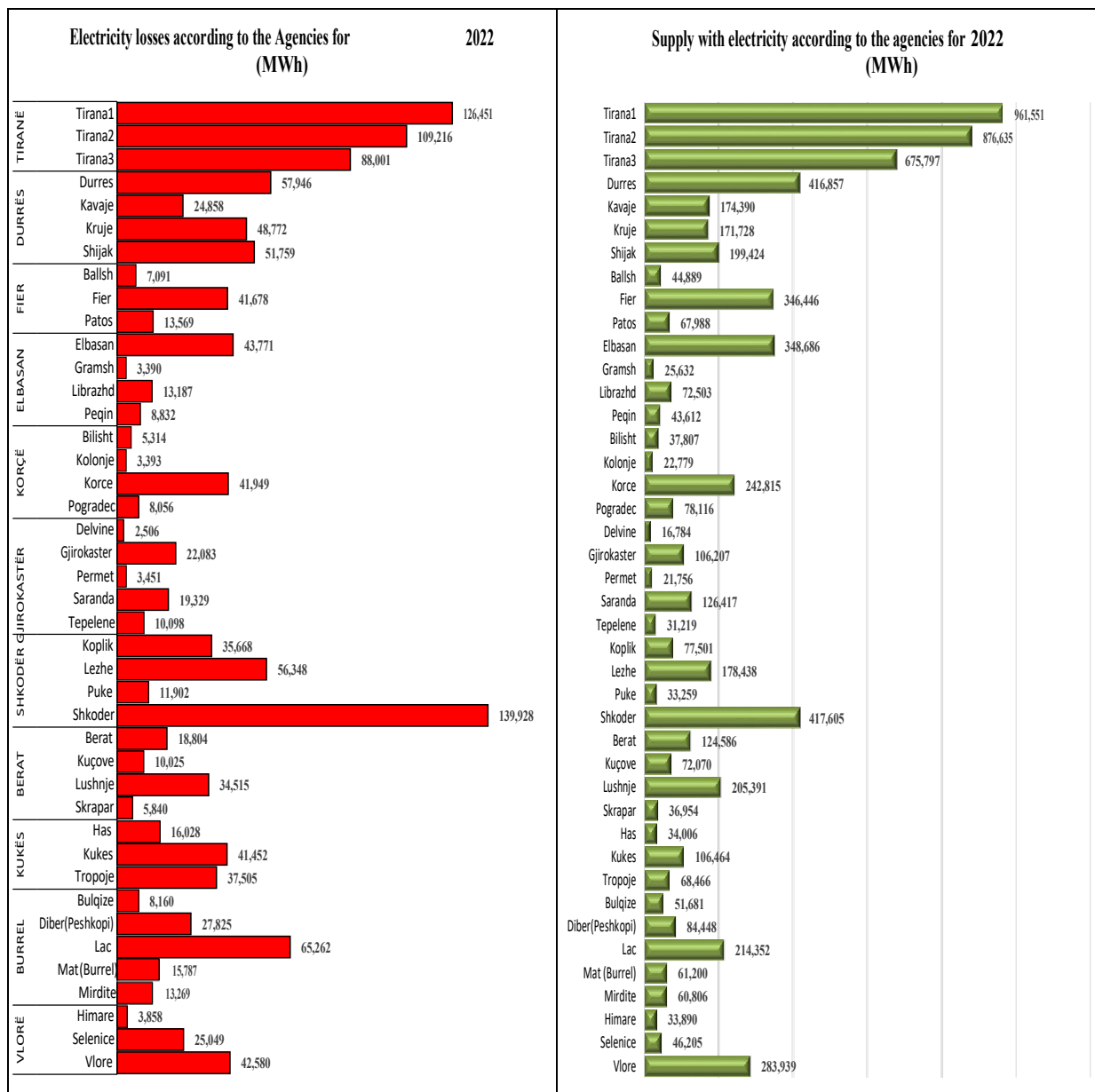

Figure 58 The quantity for the supply and the electricity losses in the regions and agencies of the distribution network

(Source: DSO company)

Based on the above-mentioned data of the periodic or specific tables and information of the electricity market operators it is build the Power Balance for 2022 as follows:

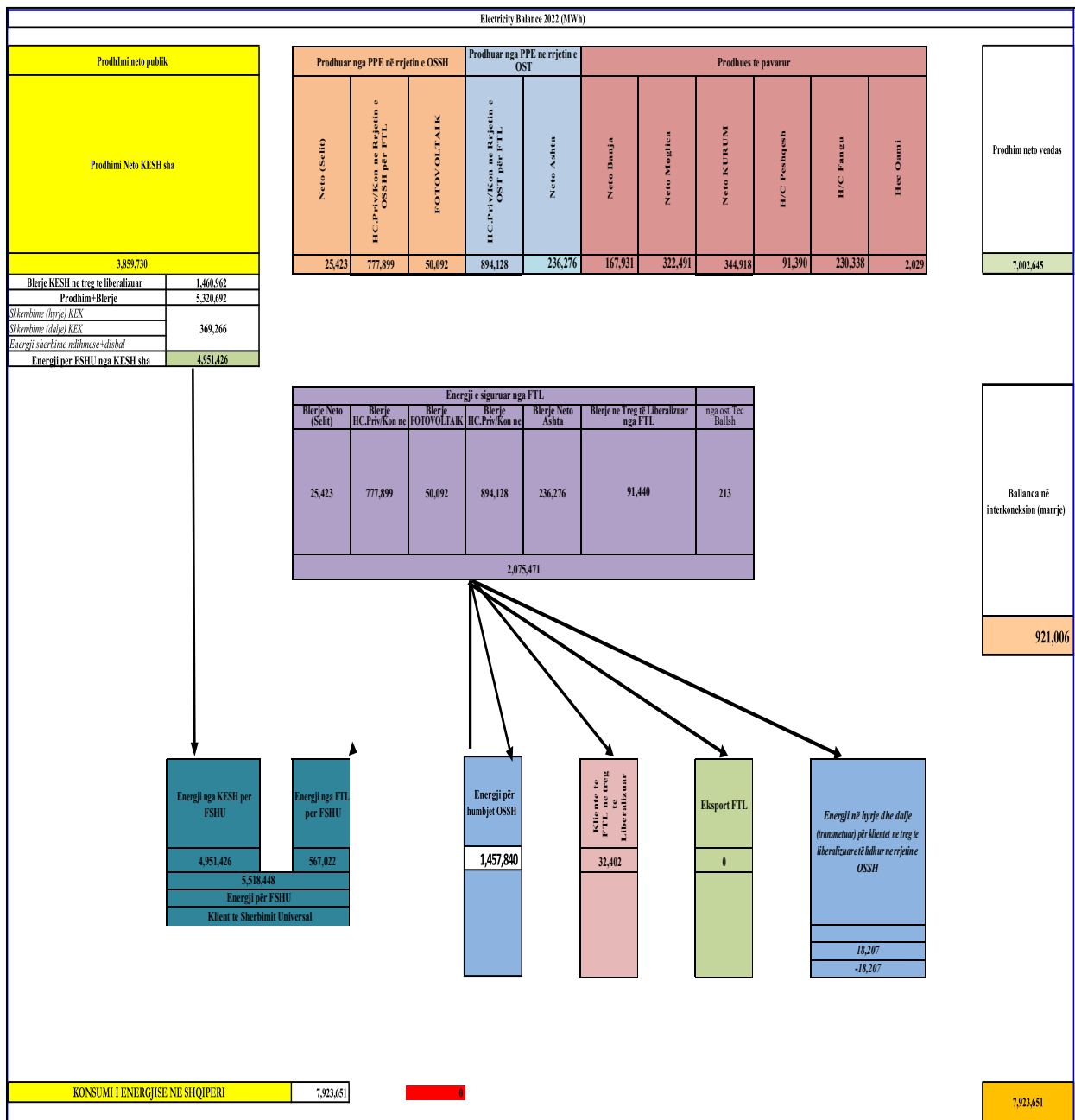

Figure 59 Power Balance of 2022 according to the reports of TSO and the DSO companies

1.4.6 Effectiveness of electricity sales

During 2021, the effectiveness of electricity sales continues in increased values, always referring to the determining factors in the level of electricity consumption efficiency, which are:

level of electricity losses in distribution;

level of collections for the invoiced electricity.

The total losses reported by the company for 2022 are **19.7 %** marking a decrease in the level of losses compared to 2021.

Total level of collections reported from the DSO company is 98 % to the total invoiced electricity (see the table as follows of invoices – collections). This level of collections for 2022 is increased compared to the level of collections for 2022 realized for 2021, of about 97,4%. These levels of collections include even the arrears, which are realized during the respective year.

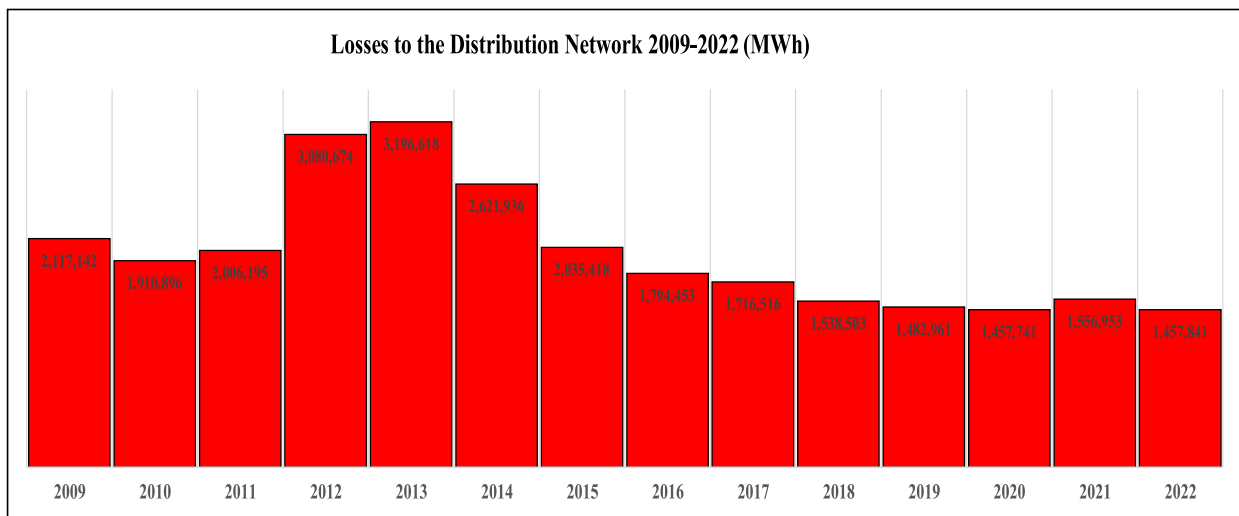

Figure 60 Annual losses to the distribution system for 2009-2022 period

(Source: DSO company)

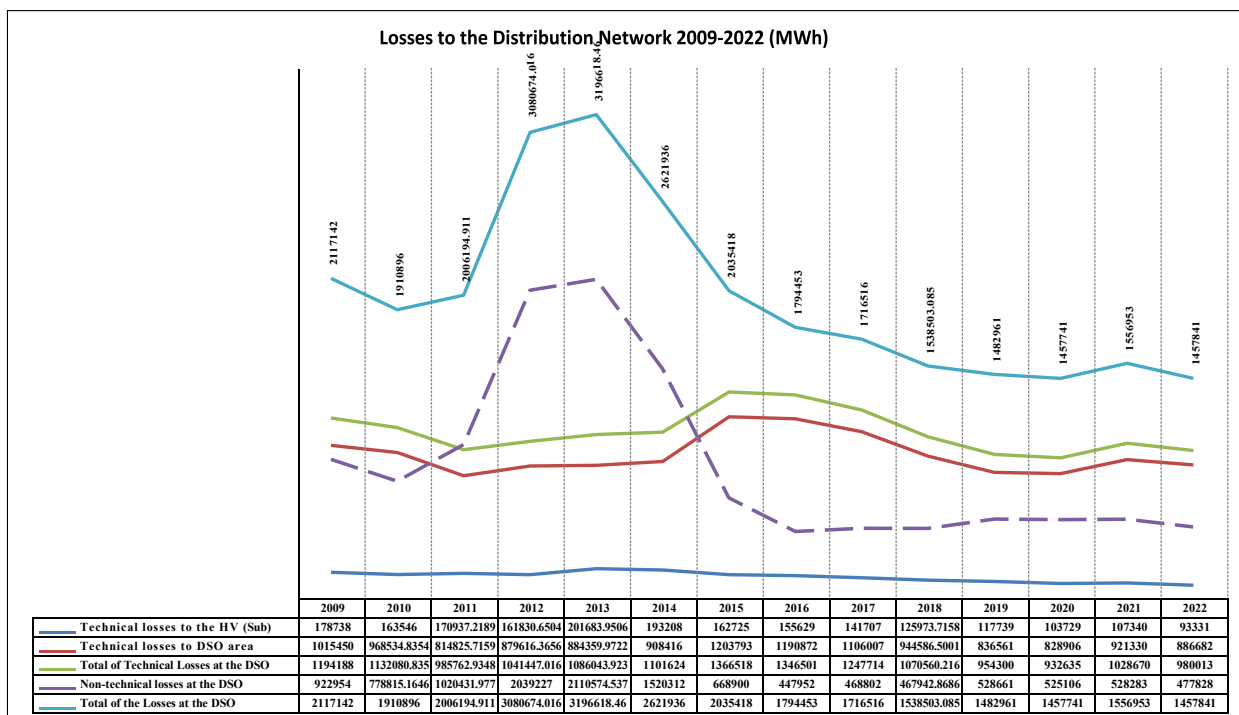

Figure 61 Graph of the annual losses to the Distribution system for 2009-2022 period

(Source: DSO company)

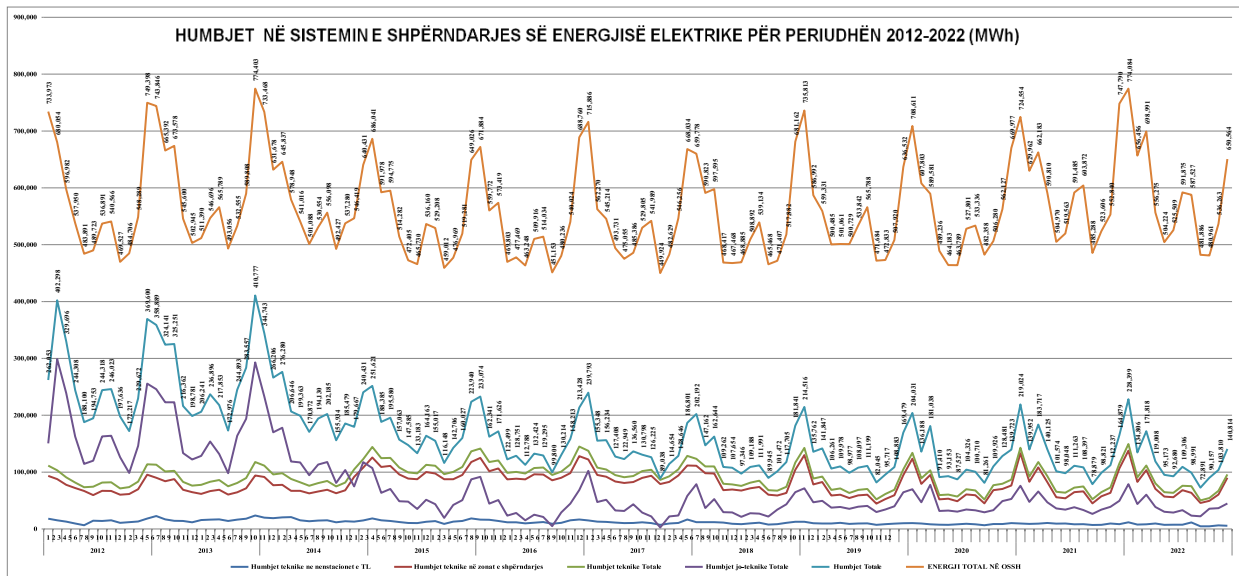

Figure 62 Annual losses to the Distribution System for 2009-2022

(Source: DSO company)

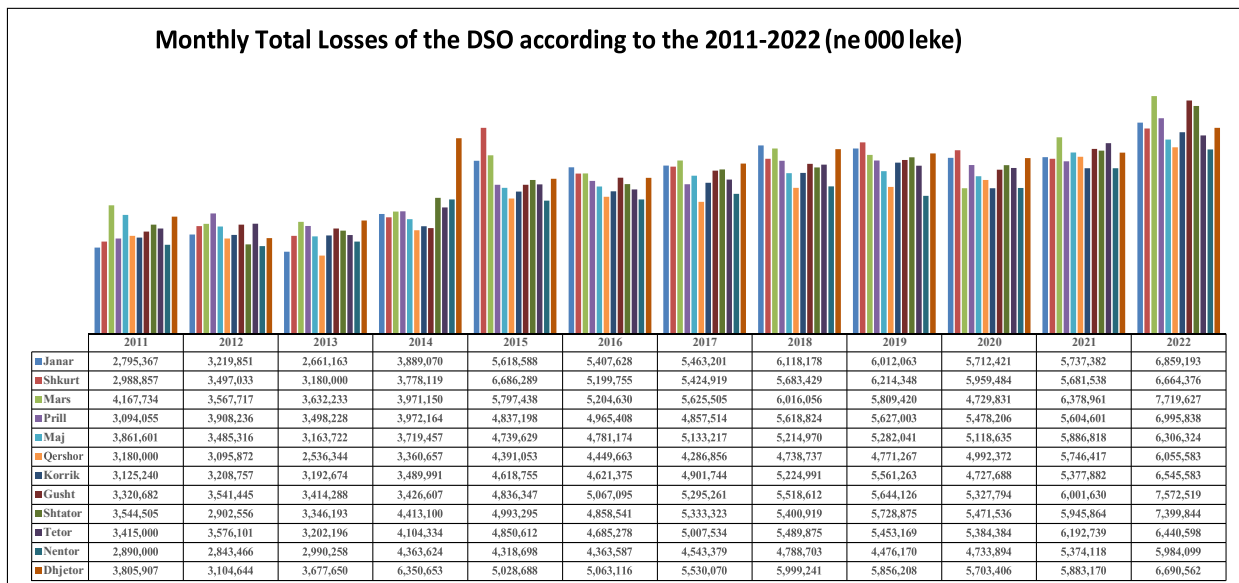

Figure 63 Level of monthly collections for 2011-2022

(Source: FSHU company)

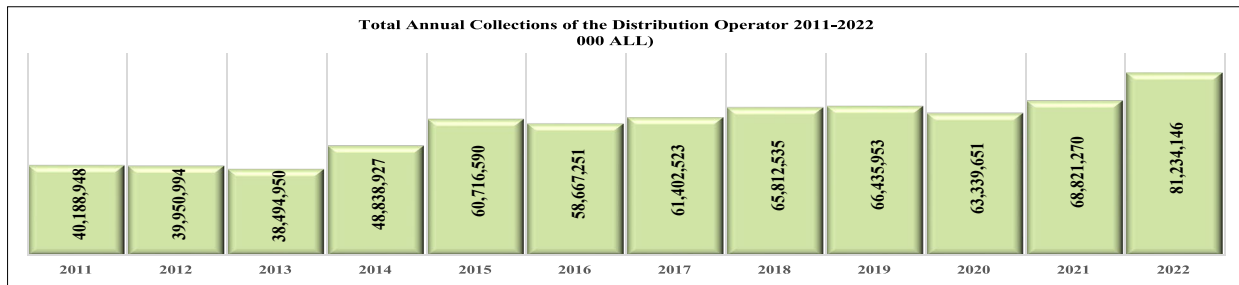

Figure 64 Total annual collections for 2011 – 2022 period

Performance of the Distribution Operator 2009-2022 (%)														
Losses Level (%) 2009-2022														
	Jan	Feb	March	Apr	May	June	July	Aug	Sept	Oct	Nov	Dec		
2009	40.75	37.05	38.05	32.93	33.44	30.75	32.60	30.20	25.34	30.67	33.44	36.89		
2010	38.62	35.41	36.90	31.37	35.17	31.45	26.94	29.69	21.47	20.61	22.16	29.05		
2011	55.55	38.00	36.95	23.11	24.85	21.29	21.88	19.41	22.95	25.15	32.20	35.70		
2012	35.72	59.16	55.23	45.41	38.87	39.77	45.51	45.51	42.09	35.53	41.89	49.32		
2013	51.12	48.71	48.29	39.66	39.52	40.33	43.33	38.50	35.08	45.98	48.08	53.04		
2014	47.00	42.14	42.78	35.69	36.85	34.10	36.59	36.36	31.67	34.52	32.88	37.54		
2015	36.68	31.82	32.88	30.54	31.24	28.60	30.62	29.29	25.30	29.92	30.82	34.50		
2016	34.69	29.00	29.93	26.07	26.97	24.35	25.97	25.15	22.12	27.11	29.30	30.99		
2017	33.50	27.63	28.66	25.81	25.88	28.31	24.69	23.29	19.79	23.76	23.55	27.90	26.41	
2018	30.65	24.91	27.22	23.33	23.03	20.76	21.46	20.77	19.32	21.53	22.73	26.70	23.9	
2019	29.25	23.21	26.5	21.36	22.10	19.92	20.42	19.81	17.54	20.40	21.58	24.76	21.79	
2020	28.22	21.61	28.36	17.39	19.10	18.65	19.69	18.87	16.80	21.21	22.79	20.49	21.48	
2021	27.87	20.1	25.92	21.08	17.92	18.34	18.75	17.93	16.22	18.56	19.88	20.25	20.62	
2022	28.42	19.66	23.68	18.24	17.08	17.30	18.42	16.81	14.94	18.36	18.38	19.76	19.70	
Level of Collections (%) 2009-2022														
	Jan	Feb	March	April	May	June	July	Aug	Sept	Oct	Nov	Dec		
2009	69.32	85.95	74.38	86.58	86.31	76.37	75.40	72.46	83.20	80.82	61.77	70.01		
2010	55.37	66.28	86.63	89.46	86.70	79.42	74.84	124.98	84.20	70.81	56.15	66.48		
2011	67.26	57.61	87.66	71.61	96.73	73.00	65.00	81.00	66.00	63.86	51.47	87.30		
2012	59.80	79.20	78.50	78.00	94.70	83.50	91.60	102.90	74.00	98.00	72.60	78.00		
2013	61.40	63.70	86.20	80.70	79.10	69.60	87.90	90.10	78.50	84.30	89.00	102.00		
2014	84.90	77.10	85.90	85.50	81.90	80.20	86.70	83.60	102.60	101.00	101.90	141.00		
2015	112.70	120.50	103.70	86.60	95.70	97.10	98.40	104.70	95.30	100.30	92.20	100.70		
2016	92.10	87.00	95.60	90.10	99.10	92.00	94.20	96.70	91.50	96.70	90.30	96.70		
2017	85.20	87.60	105.70	94.50	105.70	91.80	104.80	97.40	94.60	103.80	92.70	100.10	96.6	
2018	96.39	95.69	105.82	98.92	111.64	100.16	105.00	102.12	93.03	108.76	96.24	108.94	101.6	
2019	90.7	92.6	99.8	102.4	102.50	94.00	104.40	99.30	93.90	104.70	89.60	110.70	98.4	
2020	91.4	91.6	77.5	106.8	101.80	102.20	96.80	95.30	96.60	101.10	91.50	101.80	95.8	
2021	86.4	88.9	102.1	91	101.20	110.70	96.90	94.10	90.70	114.70	96.90	101.50	97.4	
2022	90.6	84.3	102.7	90.5	98.00	97.90	99.90	105.00	100.60	104.50	102.30	102.90	98.0	
Sales effectiveness (%) 2009-2022														
	Jan	Feb	March	April	May	June	July	Aug	Sept	Oct	Novem	Dec		
2009	41.1%	54.1%	46.1%	58.1%	57.4%	52.9%	50.8%	50.6%	62.1%	56.0%	41.1%	44.2%		
2010	34.0%	42.8%	54.7%	61.4%	56.2%	54.4%	54.7%	87.9%	66.1%	56.2%	43.7%	47.2%		
2011	29.9%	35.7%	55.3%	55.1%	72.7%	57.5%	50.8%	65.3%	50.9%	47.8%	34.9%	56.1%		
2012	38.4%	32.3%	35.1%	42.6%	57.9%	50.3%	49.9%	56.1%	42.9%	63.2%	42.2%	39.5%		
2013	30.0%	32.7%	44.6%	48.7%	47.8%	41.5%	49.8%	55.4%	51.0%	45.5%	46.2%	47.9%		
2014	45.0%	44.6%	49.2%	55.0%	51.7%	52.9%	55.0%	53.2%	70.1%	66.1%	68.4%	88.1%		
2015	71.4%	82.2%	69.6%	60.2%	65.8%	69.3%	68.3%	74.0%	71.2%	70.3%	63.8%	66.0%		
2016	60.2%	61.8%	67.0%	66.6%	72.4%	69.6%	69.7%	72.4%	71.3%	70.5%	63.8%	66.7%		
2017	56.7%	63.4%	75.4%	70.1%	78.3%	65.8%	78.9%	74.7%	75.9%	79.1%	70.9%	72.2%	71.1%	
2018	66.8%	71.9%	77.0%	75.8%	85.9%	79.4%	82.5%	80.9%	75.1%	85.3%	74.4%	79.9%	77.3%	
2019	64.2%	71.1%	73.4%	80.5%	79.8%	75.3%	83.1%	79.6%	77.4%	83.3%	70.3%	83.3%	77.0%	
2020	65.6%	71.8%	55.5%	88.2%	82.4%	83.1%	77.7%	77.3%	80.4%	79.7%	70.6%	80.9%	75.2%	
2021	62.3%	71.0%	75.6%	71.8%	83.1%	90.4%	78.7%	77.2%	76.0%	93.4%	77.6%	80.9%	77.3%	
2022	64.9%	67.7%	78.4%	74.0%	81.3%	81.0%	81.5%	87.3%	85.6%	85.3%	83.5%	82.6%	78.7%	
	2009	2010	2011	2012	2013	2014	2015	2016	2017	2018	2019	2020	2021	2022
Collection	76.4	70.1	70.7	83.0	79.3	91.9	100.8	93.4	96.6	101.6	98.4	95.8	97.4	98.0
Losses	34.0	30.4	37.6	46.4	45.0	37.8	31.3	28.0	26.4	23.9	21.8	21.5	20.6	19.7
Effectiveness	50.4	48.8	44.1	44.5	43.6	57.2	69.2	67.2	71.1	77.3	77.0	75.2	77.3	78.7

Figure 65 Progress of the sales effectiveness indicators of the DSO (%)

(Source: DSO company)

The sales effectiveness of FSHU company represents the percentage (%) of electricity that is sold and collected. For 2022, the effectiveness of sales for FSHU company is 78.7 %, or 1.4 % higher than for 2021.

The effectiveness of the sales for 2009- 2022 period is submitted on the graph as follows:

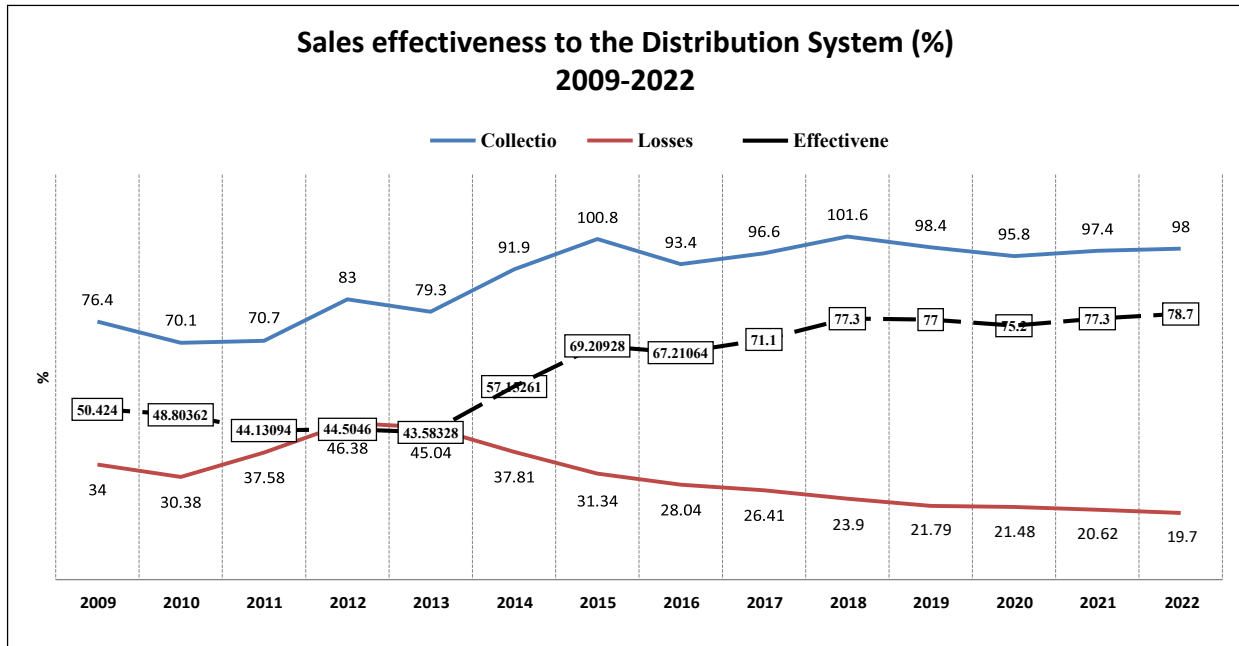

Figure 66 Sales effectiveness of FSHU company / OSHEE Group, 2009-2022

(Source: FSHU company / OSHEE Group)

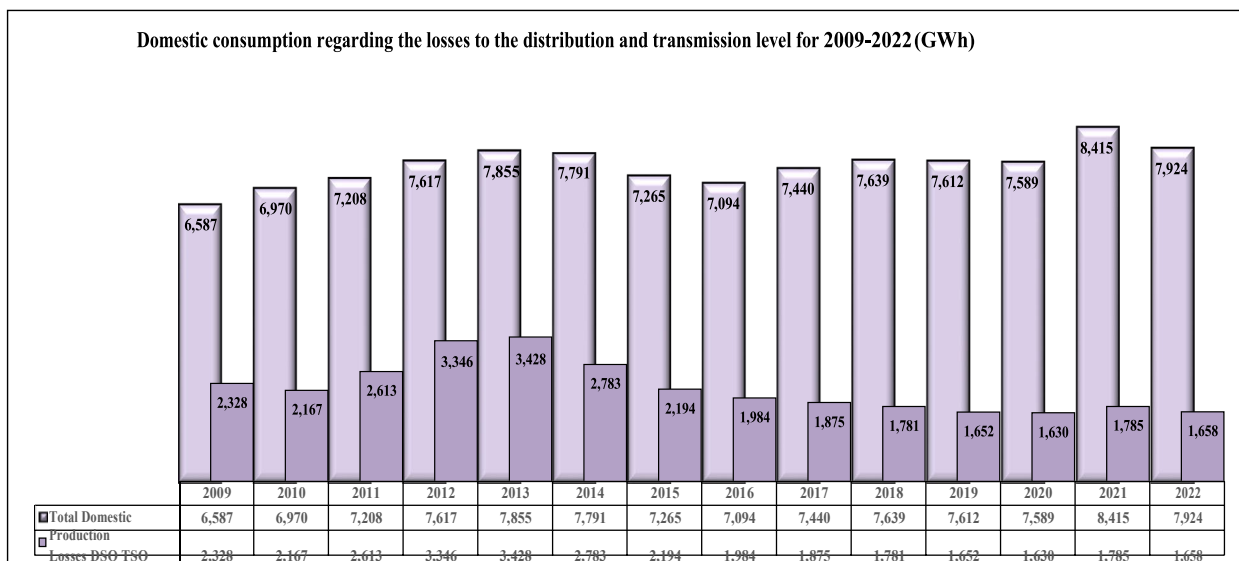

Figure 67 Total losses to the Energy introduced in the Power System to consumption

On the above figure it is submitet the progress of total electricity losses, that includes the losses in the distribution system and those in transmission system during 2009 – 2022 period. The data show that the electricity losses in absolute values are generally decreased. For 2022, the electricity losses in the distribution and transmission system are 1,658 GWh, compared with 2021 period, it is notified a decrease of the total electricity losses with about 127 GWh. At the same time shall be evidenced the fact that the decrease of electricity consumption for 2022, compared to 2021, is about 491 GWh.

On the following figure are submitted the data for the invoice – collection of electricity during 2009 – 2022 period. As shown even on the graph, until 2014 the difference between the invoicing and the collection has been considerable. The difference between the invoicing and the collection reached the maximum level in 2011 of about 30%. For 2021 period, the difference between the invoicing and collection is 3.8 milliard ALL, or about 5% of the invoiced electricity amount. The considerable decrease of the difference between the invoiced electricity and the collected one initiated on 2015 and continued with a considerable progress on the next years.

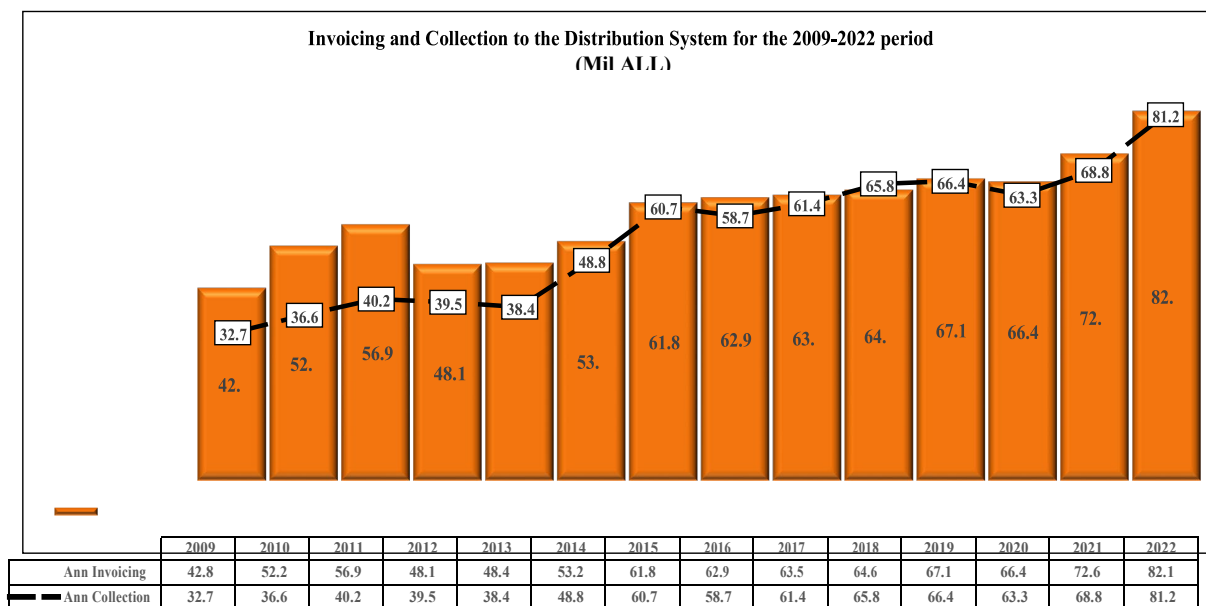

Figure 68 Invoicing/collection 2009-2022 period, with VAT

(Source: DSP company)

1.4.7 Assets of the Electricity Distribution Operator

The table as follows submits the data regarding the assets under DSO company for 2022, like the substations, lines, cabins and transformers in the electricity distribution network.

The data on the DSO assets include the data on the main element of the electricity distribution network. The number of the substations, transformers, the length of the air and cable lines as well as the number of the electricity cabins. The total number of the electricity cabins in the distribution network for 2022 is 26,059 from which 13,308 are on DSO company ownership and the other part are owned by private entities.

The total length of the medium voltage lines in the distribution system is 17,505 km. The total length of the low voltage network in the distribution system is 48,064 km. In a detailed way the data are submitted on the below table:

The data of the DSO Network for 2022 period																							
Substations, Cabins, Transformers		Cabins	Type and Number of Cabins													Installed Capacity (kVA)				Number of Capacity MV/LV			
			Metalic			Masonry			Box			Pillar			Total no of the cabins								
No of Substations	181		6 kV	10kV	20kV	6 kV	10kV	20kV	6 kV	10kV	20kV	6 kV	10kV	20kV		6 kV	10kV	20kV	Total	6 kV	10kV	20kV	Total
No of transformers to substations	313	Total	325	268	10	259	3726	4127	58	88	2036	6805	5924	98	26,059	1,604,647	1,753,187	2,828,215	6,186,049	9,688	10,101	6,929	26,718
No of cabins in total	25,059	OSHEE ownership	248	197	2	1,642	2,588	2,112	41	53	1,946	1,999	2,416	64	13,308	784,691	1,056,377	1,687,696	3,528,764	3,834	5,353	4,467	13,654
No of transformers MV/LV	26,718	Non-OSHEE ownership	77	71	8	952	1,138	2,015	17	35	90	4,806	3,508	34	12,751	819,956	696,810	1,140,519	2,657,285	5,854	4,748	2,462	13,064
Total Length of the Network MV (km)	11,450.7	Total Length of the Network LV (km)	48,065																				
35 kV (km) Air Line	1244.6	Airborne Transmittor (km)	17,410																				
35 Kv (km) Cable Line	17.5	Air with cable ABC(km)	5,817																				
20 Kv (km) Cable line	238.3	PVC, XLPE Cable	4,658																				
20 Kv (km) Cable line	2441.8	coaxial cable	20,180																				
10 Kv (km) Air Line	7508.5																						
10 Kv (km) Cable line	410.1																						
6 Kv (km) Cable Line	4876.2																						
6 Kv (km) Cable line	767.8																						

Figure 69 The data on the main assets of DSO company

2. ELECTRICITY MARKET

The electricity market even during 01.01 2022 – 29.06.2022 operated according to Council of Minister Decision no. 244 dated 30.03.2016, as amended “On approving the conditions for setting public service obligation, that shall be implemented to the licensee on Power sector, which exercise electricity production, transmission, distribution and supply activities”. For the following period of 2022, the Electricity Market operated according to Council of Minister Decision no. 456 dated 29.06.2022, “On approving the conditions for setting public service obligation, that shall be implemented to the licensee on Power sector, which exercise electricity production, transmission, distribution and supply activities”.

The Council of Minister Decision no. 584, dated 08.10.2021, “On announcing the Emergency Situation for Electricity Supply”, through which it is decided the announcement of the emergency situation for the period from October 2021 to 15 April 2022, amended with Council of Minister Decision no. 650, dated 10.10.2022 for some additions and amendments on Council of Minister Decision no. 584, dated 08.10.2021, "On announcing the Emergency Situation for Electricity Supply”, above others it postpones the emergency situation of electricity supply until 30 June 2023 period.

Council of Minister Decision no. 519, dated 13.07.2016 “On Approving the Electricity Market Model”, has not initiated to be implemented since it was determined to be implemented with the effectiveness and operational commencement of the day ahead market and the operation of the Power Exchange.

The above Council of Ministers Decisions no. 244, of date 30.03.2016, as amended, as well as no. 456 of date 29.06.2022, are defined the Electricity Market Participants in Albania, as well as the responsibilities of each market participant charged with public service obligation, serving as a temporary model of the electricity market.

With the entry into force of Law no. 43/2015 “On Power Sector” as amended, the Energy Regulator Authority, to reflect the requirements of this law, continued the work for approving, reviewing or improving the regulatory framework and the by-laws on its implementation.

The operation of the electricity market even for 2022 continued to be based on temporary electricity market rules, approved with ERE Board Decision no. 139, dated 15.08.2016, as amended.

During 2022 it continued the liberalization process of Electricity Market regarding the establishment of the technical conditions and the regulatory and by-legal framework for the issue in the open market and for the customers connected in medium voltage (35kV, 20kV, 10 kV, 6 kV) implementing Law no. 43/2015 “On Power Sector”, as amended and the respective by-legal acts.

This process will follow even in the next years with the issue in the market of the customers connected in 20 kV, 10 kV, 6 kV voltage, to guarantee the rights of the electricity suppliers, and also of the customers, ERE fulfilled the legal regulatory framework with the necessary basis to guarantee safe, transparent operation and on non-discriminatory basis of the electricity market.

The number of customers for which it is possible the establishment of the technical conditions for the issue in the irregulated market during 2022 is about 71, while in January 2022, the DSO announced the establishment of the technical rules from the DSO company for the further liberalization of market.

2.1 Monitoring Electricity Market Activity

2.1.1 Electricity Market Monitoring

Pursuant to Law no. 43/2015 “*On Power Sector*”, as amended Article 7, Article 20, letters ç), d), f) and g), Article 22, Article 58, point 9, Article 62, point 4 and Article 72, letter dh); Council of Ministers Decision no. 244, dated 30.03.2016, as amended “*On approving the conditions to impose public service obligation for the licensees on power sector, which perform the electricity generation, transmission, distribution, and electricity supply*”, as amended Article 13; as well as the conditions of licenses issued by ERE, the services of operators licensed by ERE are monitoring object regarding the meeting of the legal obligations and the implementation of ERE rules, decisions and orders.

Pursuant to the abovementioned, and the bylaws issued implementing the sector law but also the obligations set out in the Albanian Assembly Decision no. 134/2019, "On approving the annual and periodic manual monitoring ", ERE is obliged to report to the Albanian Assembly regarding the findings during the exercise of its monitoring function.

Regarding the above, ERE, to have a full review for the operation of the electricity market development, beyond the control of the periodic reports made by the licensees, during 2022 are performed the monitorings with specific objects to the licensees ensuring the necessary data and information to serve the abovementioned purpose. The results and analysis are submitted on the I-rst Part of this report “*Situation of the Sector and the Electricity Market*”, giving the opportunity to compare with the previous years and the comparable approach with the progress of the data for which are set the targets on Chapter VI “The Implementation plan” of Council of Minister Decision no.253, dated 24.04.2019, amended with Council of Minister Decision no.758, dated 09.12.2021 “On

approving the financial consolidation plan of the power public sector”.

To ensure the most accurate and timely reporting by licensees and electricity market participants with ERE Board Decision no. 203, dated 12.12.2019, are approved the "Rules to monitor the electricity market" On these rules there are defined the reporting procedures and forms of sending the information and data at ERE from the Market Participants.

ERE is in process of developing an electronic platform which shall enable to electricity market participants to complete all the obligations deriving from EU Directives and Regulations as well as Law no. 43/2015 “On Power Sector” as amended and law no. 102/2015 “On natural gas sector” as amended, and shall simultaneously serve to all interested parties to obtain the necessary information and data as soon as possible. Also, this shall positively contribute following the improvement of the data publication practices from ERE implementing Article 19, letter k) and Law no. 43/2015 “On Power Sector” as amended.

From the analysis of the results and the process of the issues and information received from ERE, it is judged according to the case to develop verifications, analysis, hearing sessions and on-site monitorings.

Also, it is analysed the situation of periodic reporting for the licensees where are found delays or failures to deliver on time from them to meet the obligation for periodic reporting within the terms defined from the entities, regarding ERE findings it continued with the relevant correspondence in the framework of improving these practices.

Representatives from ERE are members of the working groups of international organizations with which ERE has already established cooperation agreements.

In this framework ERE information provided from the periodic reports send to various institutions and organizations that collaborate with ERE, also its participation at the meetings that are within its scope of work, these monitored and analysed data serve also as a contribution at the practices of these institutions as well as in completing the questionnaires and correspondences.

To increase the transparency in the electricity market, ERE continued to monitor the implementation of ERE Board Decision no. 118, dated 27.07.2017, that approved the “Rules for the data publication based on the electricity market”.

The main (4) four months data that are most frequent for electricity market operation continued to be published even for 2022 regularly on ERE website, according to the provisions of law no. 43/2015 “On Power Sector” as amended. These data issue the information and detailed reports regarding electricity production, transmission, distribution and electricity supply and for the electricity market in our country.

In order to ensure the implementation of the legal and by-legal provisions of the obligations related to transparency in the energy market, ERE periodically monitored the official website of the main operators in the energy market. It results that for 2022 these obligations are implemented mainly by operators in the framework of increasing transparency and in each case by ERE are done the official letters requiring the operators to improve this process by identifying the relevant obligations that shall be complied implementing the respective acts.

From the operators, it is noticed the increase of the information that is published in the framework of transparency, mainly TSO through the transparency platform of ENTSO-E, this is due to the fact that TSO company is a member of ENTSO – E and is obliged to publish the information even on the

transparency platform of this organization. Although improvements of this process shall continue and become one of the objectives of ERE in continuation, this is underlined even during 2022 and following the official communication of ERE with the Energy Community Secretariat and TSO company.

Some of the specific monitorings for the licensees and the market participants are submitted as follows:

2.1.2 Specific monitorings from the periodic information of TSO company

I. Allocation of the capacities at the interconnections

On the following table are submitted the allocation of the capacities of the interconnection according to the borders.

CAPACITIES ALLOCATION 2022																			
Auction	Period	Albania i - Monte Negro						Albania - Greece						Albania - Kosovo					
		ATC provided to the auction		ATC sold to the Auction		Auction Price		ATC provided to the Auction		ATC sold to the Auction		Auction Price		ATC provided to the Auction		ATC sold to the Auction		Auction Price	
		Export	Import	Export	Import	Export	Import	Export	Import	Export	Import	Export	Import	Export	Import	Export	Import	Export	Import
		[MW]	[MW]	[MW]	[MW]	[Euro/MWh]	[Euro/MWh]	[MW]	[MW]	[MW]	[MW]	[Euro/MWh]	[Euro/MWh]	[MW]	[MW]	[MW]	[MW]	[Euro/MWh]	[Euro/MWh]
Jan	01.01.2022-31.01.2022	101	100	101	100	2.07	1.47	200	202	200	202	1.11	3.47	200	200	200	200	0.83	0.41
Fenr	01.02.2022-28.02.2022	103	102	102	105	1.55	2.22	200	154	200	154	1.5	3.51	202	200	202	199	1.53	0.65
March	01.03.2022-31.03.2022	103	102	103	102	0.91	3.98	100	102	100	102	2.55	1.51	200	200	200	200	0.31	1.11
	102							107	102	107	0.84	0.79							
	2							4	0	2	0.84	0.79							
April	01.04.2022-03.04.2022	101	100	101	100	2.25	3.33	100	5	99	5	2.71	9.69	200	200	200	200	0.71	1.11
	04.04.2022-05.04.2022							50	50	49	48	0.71	1.11						
	06.04.2022-15.04.2022							200	200	200	200	0.71	1.11						
	16.04.2022-30.04.2022							200	200	200	200	0.71	1.11						
May	01.05.2022-02.05.2022	101	100	101	100	1.29	3.55	200	0	193	0	4.00	0	200	200	200	200	0.26	0.95
	03.05.2022-06.05.2022							0	0	0	0	4.00							
	07.05.2022-12.05.2022							200	0	193	0	4.00							
	13.05.2022-24.05.2022							300	0	300	0	4.00							
	25.05.2022-31.05.2022							200	0	193	0	4.00							
June	01.06.2022-30.06.2022	101	100	101	100	0.89	3.69	200	5	200	5	4.20	3.99	202	200	202	200	0.61	1.35
July	01.07.2022-31.07.2022	101	100	100	100	0.55	3.89	200	202	200	202	2.79	2.99	200	200	200	199	0.23	3
Aug	01.08.2022-12.08.2022	101	100	101	100	1.4	3.56	200	0	200	0	2.83	5.23	200	200	200	200	0.22	1.97
	13.08.2022-15.08.2022							50	0	46	0	2.83							
	16.08.2022-23.08.2022							200	157	200	157	2.83							
	24.08.2022-25.08.2022							200	0	200	0	2.83							
	26.08.2022-31.08.2022							200	0	200	0	2.83							
Sept	01.09.2022-30.09.2022	101	100	101	100	1.55	1.65	200	202	200	202	1.32	12.31	200	200	200	200	0.28	2.55
Oct	01.10.2022-02.10.2022	101	100	101	99	3.13	2.55	200	202	200	202	3.21	5.51	200	200	200	200	0.81	1.35
	03.10.2022-07.10.2022							100	102	96	98								
	08.10.2022-09.10.2022							200	202	200	202								
	10.10.2022-21.10.2022							100	102	96	98								
	22.10.2022-31.10.2022							200	202	200	202								
Nov	01.11.2022-06.11.2022	101	100	100	100	2.88	4.44	200	152	200	152	4	6.22	200	200	200	200	0.88	1.98
	07.11.2022-11.11.2022							100	152	95	152	4							
	12.11.2022-30.11.2022							200	152	200	152	4							
Dec	01.12.2022-31.12.2022	101	100	101	100	3.33	6	200	152	200	152	3.78	4.22	200	200	200	200	0.8	3.15

Figure 70 Data on Capacities Allocation Auction to the Transmission System during 2022

(Source: TSO company)

As it can be seen, in most cases there has been congestion in capacities allocation by the imports /exports.

For the capacities allocation in interconnections, during 2022 are followed the procedures according to the harmonized rules of the Coordinated Office of Capacities Allocation of the Interconnection for the Southeast Europe (SEE CAO).

The Auctions for the capacities in interconnection are held in conformity with the terms and procedures defined on the Auction Regulation on Capacities Allocation at SEE CAO.

It is worth mentioning that there were no complaints from Market Participants, participated in the auction, about the deadlines, procedures, auction process, bid evaluation process, determination of winners and auction prices, communication and publication of notice of auction and their results.

Electricity Market implementation is also a mutual cooperation and assessment process between Market Operators and Market Participants, according to their respective role in the energy market.

II. Imbalances on the electricity market

Implementing the “Albanian Electricity Balancing Market Rules” approved with ERE Board Decision no. 106, dated 02.07.2020, TSO company beginning from 1 April 2021 operated on the electricity balancing market implementing these rules with financial effects for the electricity market participants making the calculations for the imbalances invoicing for each market participant that are responsible for the imbalances caused on hourly basis. These rules set clear principles of a competitive and dynamic market regarding the electricity balancing.

The Council of Ministers according to Article 100 of the Constitution and point 4, of Article 99, Law no. 43/2015, "On Power Sector", as amended issued decision no. 389 dated 09.06.2022, “On handling the imbalances caused from electricity priority producer”. The effectiveness of this decision fully completes the legal framework for handling the imbalances in electricity market.

Above all on this Council of Minister Decision, Paragraph III “General Principles” on the respective points 1 and 2 it is defined that:

According to Article 22.5, of Law no.7/2017, “On the promotion of energy from renewable resources”, and the balancing market rules, approved by ERE, the electricity priority producers are responsible for the imbalances and their respective costs that they cause to the system, according to the Albanian electricity balancing market rules, approved by ERE.

The electricity priority producers, which have an electricity sale – purchase contract with the company charged with public service obligation for the electricity purchase from the renewable resources, from 1 April 2021 that are automatically part of the Balancing Group of the Operator for Renewable Energy (OER).

The imbalances of the market participants during 2022 are calculated and invoiced on mothly basis, for 1-hour time period.

The market operation is a continuous monitoring object by the ERE.

On the following table are submitted the imbalances for 2022 of the balancing responsible parties.

Pale Përgjegjëse Balancuse	DISBALANCAT 2022																									
	JANAR		SHKURT		MARS		PRILL		MAJ		QERSHOR		KORRIK		GUSHT		SHTATOR		TETOR		NENTOR		DHJETOR		TOTALI 2022	
	Dis. Negative (MWh)	Dis. Pozitive (MWh)	Dis. Negative (MWh)	Dis. Pozitive (MWh)	Dis. Negative (MWh)	Dis. Pozitive (MWh)	Dis. Negative (MWh)	Dis. Pozitive (MWh)	Dis. Negative (MWh)	Dis. Pozitive (MWh)	Dis. Negative (MWh)	Dis. Pozitive (MWh)	Dis. Negative (MWh)	Dis. Pozitive (MWh)	Dis. Negative (MWh)	Dis. Pozitive (MWh)	Dis. Negative (MWh)	Dis. Pozitive (MWh)	Dis. Negative (MWh)	Dis. Pozitive (MWh)	Dis. Negative (MWh)	Dis. Pozitive (MWh)	Dis. Negative (MWh)	Dis. Pozitive (MWh)	Dis. Negative (MWh)	Dis. Pozitive (MWh)
KURUM INTERNATIONAL	298	33	863	645	1,142	351	1,203	540	965	174	796	529	124	45	26	114	69	26	68	74	1,101	777	1,158	353	7,813	3,669
DEVOLL HP	34	561	164	67	120	75	23	65	439	54	18	29	18	21	54	47	9	33	9	21	12	24	490	49	1,389	1,047
DRAGOBIA ENERGY																										
GENI	762	404	629	550	759	168	866	148	778	150	560	292	491	295	1,296	544	1,308	455	863	232	988	504	851	989	10,140	4,733
ENERGIA GAS & POWER ALB	654	178	327	37	317	59	348	64	580	29	793	0	333	12	308	16	184	20	173	22						
ENER TRADE ENERGY 24									289	830	157	1,380	503	527												
AVEN AS ENERGIJ	284	107	30	73	64	49	117	104	69	38	57		58	28	46	18	148	98	99	32	172	106	315	283	1,461	936
GSA	2,749	28	1,925	131	4,701	370	1,418	521	1,344	598	3,689	200	1,527	25	2,198	231	1,279	27	319	250	271	494	218	1,465	22,638	4,338
Albanian Energy Supplier AES	1,355	79																								
Future Energy Trading																										
Furnisuesi i Trepes te Lire FTL (KESH)	3,460	22,693	4,420	26,210	3,732	25,481	4,192	27,211	3,971	14,722	3,851	10,423	3,364	15,886	3,330	13,831	2,516	18,670	1,552	14,489	5,560	17,979	2,209	33,464	41,157	241,064
KESH (Pale Përgjegjëse Balancuse)	308	2,462	759	4,118	512	2,936	344	5,900	374	2,523	421	1,878	523	1,655	794	1,505	1,021	1,944	314	2,585	1,397	2,495	4,730	1,885	11,497	31,487
EZ-S ENERGY	129	8	24	18	20	5																				
BVLLIS Tër Balah (Pa kontrate Furnisuesi)	71		61		66		15																			
KOSTI	2,703	12,584	2,683	10,333	1,137	14,239	4,576	8,666	6,960	5,197	9,615	2,280	3,806	9,169	6,288	6,007	3,465	8,126	909	14,056	11,890	1,562	12,398	2,530	66,430	94,748
OST- HUMBLET	5,028	1,506	1,278	2,229	1,619	2,889	14,685	2	8,262	49	6,931	12	3,024	504	900	1,244	955	2,021	1,326	1,055	657	3,597	1,566	49,980	13,733	
Oftuesi i Sherbimit te Balancimit	Ulte Gjenerimi (MWh)	Rendje Gjenerimi (MWh)	Ulte Gjenerimi (MWh)	Rendje Gjenerimi (MWh)	Ulte Gjenerimi (MWh)	Rendje Gjenerimi (MWh)	Ulte Gjenerimi (MWh)	Rendje Gjenerimi (MWh)	Ulte Gjenerimi (MWh)	Rendje Gjenerimi (MWh)	Ulte Gjenerimi (MWh)	Rendje Gjenerimi (MWh)	Ulte Gjenerimi (MWh)	Rendje Gjenerimi (MWh)	Ulte Gjenerimi (MWh)	Rendje Gjenerimi (MWh)	Ulte Gjenerimi (MWh)	Rendje Gjenerimi (MWh)	Ulte Gjenerimi (MWh)	Rendje Gjenerimi (MWh)	Ulte Gjenerimi (MWh)	Rendje Gjenerimi (MWh)	Ulte Gjenerimi (MWh)	Rendje Gjenerimi (MWh)	Ulte Gjenerimi (MWh)	Rendje Gjenerimi (MWh)
Devoll HP Energji Akt		117						18	13	53															13	188
Devoll HP Energji Shtese Akt																										-
Aven AS Energji Energji Akt																										-
Aven AS Energji Energji Shtese Akt																										-
KESH (k.a. Energji Akt)	6,925	4,233	8,165	3,878	8,206	4,472	6,127	4,668	6,162	5,290	5,491	4,488	5,974	5,206	6,960	3,480	7,406	3,568	4,859	4,883	5,392	5,960	11,714	1,771	83,382	51,868
KESH (k.a. Energji Shtese Akt)	2,431	175	4,569		1,740		2,289	141	1,924		1,448	44	3,619	204	4,083	1,057	8,974	1,901	3,308	1,772	2,437	5,146	7,607	3,702	44,430	14,143
TOTALI	27,120	45,168	25,837	48,288	24,070	51,093	36,189	47,658	32,129	29,707	33,827	21,576	23,364	33,576	26,273	28,095	27,855	36,958	13,867	39,895	31,856	36,085	45,458	48,411	347,844	466,510
Disbalancat mujore (MWh)		18,048		21,452		17,022		11,469		(4,422)		(12,251)		10,212		1,822		9,103		16,028		4,229		2,954		118,666

Sumarized Table for 2022

MWh	Jan	Feb	March	April	May	June	July	Aug	Sept	Oct	Nov	Dec
Negative Imbalance	17,834	13,163	14,190	27,788	24,030	26,888	13,771	15,230	11,475	5,699	24,026	26,137
Positive Imbalance	40,643	44,410	46,621	42,831	24,365	17,044	28,166	23,557	31,490	33,269	24,978	42,938

Disbalancat Mujore 2022 (MWh)

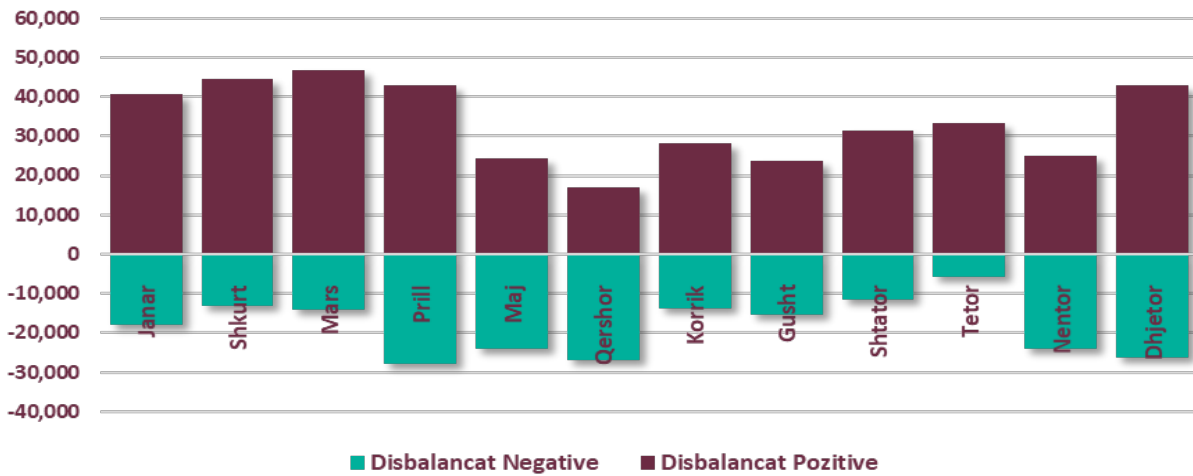

Figure 71 Total imbalances for 2022 (MWh)

Source TSO company.

2.1.3 Other monitorings related to the activity of the licensees in the Power Sector.

Periodic monitoring of the indicators and the main data of the Power Sector for 2022

On the following table are submitted the main data of the power sector for 2022, where there are reflected the values set as target on Chapter VI "Implementation plan" of the Council of Ministers Decision no. 253, dated 24.4.2019, as amended with Council of Minister Decision no. 758 dated 09.12.2021 "On the approval of the financial consolidation plan of the power public sector"

The table enables the comparison of these data as in the "Fact" column are given the realized data for 2021 period while on "Target" column are given the data defined on Council of Minister Decision no. 253/2019 as amended with Council of Minister Decision no. 758/2021. As evidenced part of 2021 indicators are realized compared to the respectively set targets, the Collection of the incomes, Net Internal Generation, Generation from Concession HPP-s and PPE, Net Generation from KESH company, while the other part of the indicators for 2021 period is not realized.

Comparison of target and fact of some of the data to the Albanian Power System for 2022 (GWh)		
	Target	Fact
Losses in distribution (import from OSHEE)	900	1,457
Losses to Transmission (TSO)	162	200
Qualified customers Industry (connected to the TSO)	826	679
Household	3 047	3 072
Total request of electricity	6 990	7 924
Net generation from KESH	3 955	3 860
Concession and Independent Electricity Producers PPE	1 935	3 143
Net Internal Generation	5 888	7 003
Total losses in distribution (%)	19.6	19.7
Collection of the revenues (%)	95	98

The amended targets with Council of Minister Decision no. 758/2021, are analyzed in details on the table and graph form as follows:

The Data on the	Losses and Collections To the Distribution System during 2022												Regarding Annual the
	Jan	Febr	March	April	May	June	July	Aug	Sept	Oct	Nov	Dec	
Collections 2022 (000 ALL)	6,859,193	6,664,376	7,719,627	6,995,838	6,306,324	6,055,583	6,545,583	7,572,519	7,399,844	6,440,598	5,984,099	6,690,562	81,234,146
Collections 2022 (%)	90.6	84.3	102.7	90.5	98.00	97.90	99.90	105.00	100.60	104.50	102.30	102.90	98.0
Target of Collections 2022	95	95	95	95	95	95	95	95	95	95	95	95	95
Losses to DSO 2022 (MWh)	228,398	134,806	171,818	118,995	95,173	92,679	109,306	98,991	72,892	90,157	103,810	140,814	1,457,840
Losses to DSO 2022 (%)	28.42%	19.66%	23.68%	18.24%	17.08%	17.30%	18.42%	16.81%	14.94%	18.36%	18.38%	19.76%	19.70%
Losses Target 2022	19.6	19.6	19.6	19.6	19.6	19.6	19.6	19.6	19.6	19.6	19.6	19.6	19.6
Losses to DSO 2022 (%)	Janar	Shkurt	Mars	Prill	Maj	Qershor	Korrik	Gusht	Shtator	Tetor	Nentor	Dhjetor	VJETORE
Losses to DSO 2022 (%)	28.42	19.66	23.68	18.24	17.08	17.30	18.42	16.81	14.94	18.36	18.38	19.76	19.70
Losses Target 2022	19.6	19.6	19.6	19.6	19.6	19.6	19.6	19.6	19.6	19.6	19.6	19.6	19.6
Collections 2022 (%)	Janar	Shkurt	Mars	Prill	Maj	Qershor	Korrik	Gusht	Shtator	Tetor	Nentor	Dhjetor	VJETORE
Collections 2022 (%)	90.6	84.3	102.7	90.5	98.00	97.90	99.90	105.00	100.60	104.50	102.30	102.90	98.0
Collections Target 2022	95.0	95.0	95.0	95.0	95.0	95.0	95.0	95.0	95.0	95.0	95.0	95.0	95.0

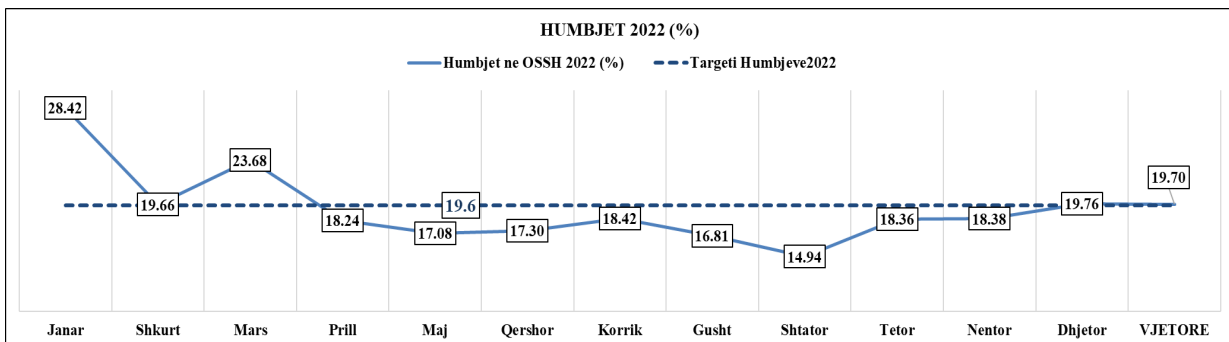
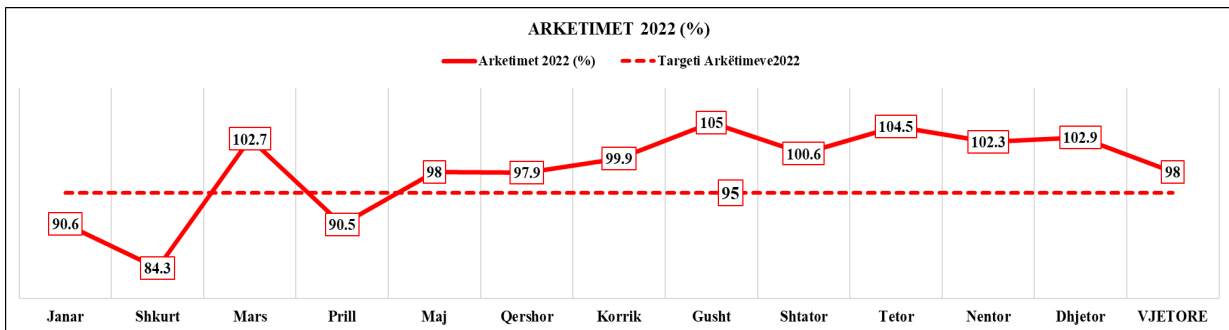

Figure 72 SEE indicators for 2022 according to the target and the fact

The target of the collections set on this Council of Minister Decision for 2022 is reached while the total losses in the distribution network for 2022 there is a slight difference with 0.1 % over the set target for the respective year.

The performed transactions from KESH company, in the open (irregulated) Market during 2022

During 2022, ERE monitored through the periodic reports the electricity purchase in the open market from the companies that are partially regulated KESH company, where it results that the average weighted price of electricity purchase in the open market from KESH company, charged with public service obligation is about 305.47 EUR/MWh, while the average weighted price of electricity sale in the open market from KESH company results about 182 EUR/MWh.

KESH company during 2022 has sold/purchased and exchanged electricity in the irregulated market mainly for optimization, implementing the “Electricity Trading Regulation from KESH company” approved with the Ministry of Infrastructure and Energy Decision no. 2762/8, dated 06.06.2019, as KESH company owner and the “General rules of organizing the commercial activity of Albanian Power Corporation KESH company.” approved with Decision no. 5233/1, dated 12.06.2020, of the

General Shareholder Assembly.

As follows it is submitted a table with the data of the detailed transactions performed during 2022 from KESH company.

Electricity purchase according to public service obligation set with Council of Minister Decision 757/2021							
Compan y	Period	Status	Quantity	Price	Amount	VAT	Amount with VAT
			MWh	Eur/MWh	Eur	Eur	Eur
Jan	01-31.01.2022	Purch	137,750	237.23	32,677,830	3,579,660	36,257,490
Febr	01-28.02.2022	Purch	209,736	230.35	48,311,804	8,254,760	56,566,563
March	01-31.03.2022	Purch	165,655	237.90	39,408,783	4,460,105	43,868,887
April	01-30.04.2022	Purch	44,328	209.62	9,291,903	276,922	9,568,825
May	01-31.05.2022	Purch	76,864	210.57	16,184,915	1,625,919	17,810,834
June	01-30.06.2022	Purch	117,973	230.84	27,233,280	3,898,089	31,131,370
July	01-31.07.2022	Purch	170,381	439.19	74,829,132	11,657,195	86,486,327
Aug	01-31.08.2022	Purch	120,030	482.32	57,892,566	8,412,720	66,305,286
Sept	01-30.09.2022	Purch	125,256	479.23	60,026,234	7,722,635	67,748,869
Oct	01-31.10.2022	Purch	144,016	339.35	48,871,988	3,573,600	52,445,588
Nov	01-30.11.2022	Purch	148,973	210.47	31,354,418	4,288,794	35,643,213
Dec	01-31.12.2022	Purch	0	0.00	0	0	0
TOTAL		Purch	1,460,962	305.34	446,082,853	57,750,399	503,833,252

Sales of KESH company on the conditions of large inflows for 2022							
Company		Status	Quanti ty	Price	Amount	VAT	Amount withH VAT
			MWh	Eur/MWh	Eur	Eur	Eur
Jan		Sale	-	-	-	-	-
Feb		Sale	-	-	-	-	-
March		Sale	-	-	-	-	-
April		Sale	11,850	143	1,688,885	290,966	1,979,851
May		Sale	-	-	-	-	-
June		Sale	-	-	-	-	-
July		Sale	-	-	-	-	-
Aug		Sale	-	-	-	-	-
Sept		Sale	-	-	-	-	-
Oct		Sale	-	-	-	-	-
Nov		Sale	47,550	196	9,334,771	909,934	10,244,705
Dec		Sale	135,136	169	22,800,882	2,958,515	25,759,398
TOTAL		Sale	194,536	174	33,824,538	4,159,416	37,983,953

Sale-purchase of electricity for financial optimization of KESH company with the procedures based on the Trading regulation							
Company	Period	Status	Quantity	Price	Amount	VAT	Amount with VAT
			MWh	Eur/MWh	Eur	Eur	Eur
Jan	01-31.01.2022	Sale	840.00	338.57	284,400.00	-	284,400.00
		Purch	-	-	-	-	-
Febr	01-28.02.2022	Sale	-	-	-	-	-
		Purch	-	-	-	-	-
March	01-31.03.2022	Sale	-	-	-	-	-
		Purch	-	-	-	-	-
April	01-30.04.2022	Sale	-	-	-	-	-
		Purch	-	-	-	-	-
May	01-31.05.2022	Sale	-	-	-	-	-
		Purch	-	-	-	-	-
June	01-30.06.2022	Sale	1,740.00	398.24	692,931.00	138,586.20	831,517.20
		Purch	1,740.00	291.37	506,983.20	101,396.64	608,379.84
Jul	01-31.07.2022	Sale	3,400.00	317.19	1,078,460.00	215,692.00	1,294,152.00
		Purch	3,400.00	281.17	955,992.70	139,636.22	1,095,628.92
Aug	01-31.08.2022	Sale	900.00	600.91	540,821.70	108,164.34	648,986.04
		Purch	720.00	525.69	378,495.00	75,699.00	454,194.00
Sept	01-30.09.2022	Sale	600.00	600.91	360,547.80	72,109.56	432,657.36
		Purch	780.00	525.85	410,160.00	82,032.00	492,192.00
Oct	01-31.10.2022	Sale	-	-	-	-	-
		Purch	-	-	-	-	-
Nov	01-30.11.2022	Sale	-	-	-	-	-
		Purch	132.00	215.79	28,484.52	-	28,484.52
Dec	01-31.12.2022	Sale	-	-	-	-	-
		Purch	-	-	-	-	-
TOTAL	Jan – Dec	Sales	7,480.00	395.34	2,957,160.50	534,552.10	3,491,712.60
		Purch	6,772.00	336.70	2,280,115.42	398,763.86	2,678,879.28

Figure 73 Transactions performed during 2022 from KESH company

On the graph of the below figure it is submitted the balance (entry – exit) electricity import – export for 2009 – 2022 period.

For the last 10-years, our country results to generally be a net importer of electricity except of the 2010, 2016, 2018 and 2021 period. Shall be clarified that the submitted values represent all entry and exit flows from all electricity market participants in Albania.

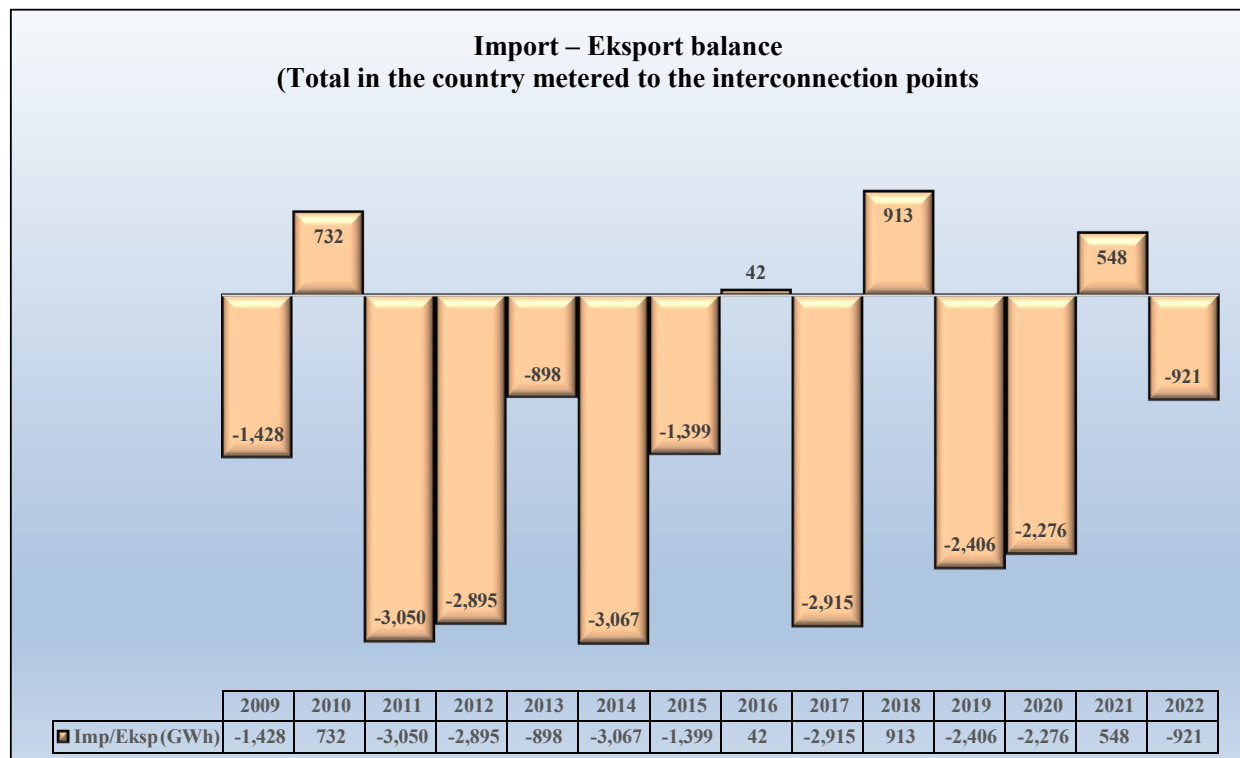

Figure 74 Import – export balance of electricity throughout the years

(Source: TSO company)

2.1.3.1 Participants registered to electricity market during 2022

On the table as follows it is submitted the full list of electricity market participants registered at TSO company, and that operate in our market. As evidenced on this table the number of electricity market participants that are registered on this table is 76, but the market participants that are active are smaller than this number.

Regarding the periodically monitored from the participants register which are registered in electricity market during 2022, it is observed that there are not encountered issues regarding its update from TSO/MO regarding the reflection of the updates for the licensees and the market participants regarding the terms issued to reflect the electricity market participants.

Also, in the framework of improving the practices for the operation and monitoring the electricity market, implementing ERE Board Decision no. 126, dated 17.05.2021, “On approving the Regulation for Wholesale Electricity Market Integrity and Transparency” (REMIT), it follows the work for its implementation.

Register of the Participants in electricity market during 2022

No	Name of the Entity	EIC Code	Registration date	TEE Role	
				Producers	Traders
	Register of Market Participants (2022)			P	T
				F	
				FSHU	
				SH	
1	Albanian Energy Supplier	54X-AEG-02-1603G	26.05.2015	T; F	
2	AXPO Albania	23X--150330-AA-K	28.1.2020	T; F	
3	Ayen AS Energji	23X--150416-A--N	17.12.2014	P; T; F	
4	Ayen Energy Trading	23X--140426-AY-W	04.05.2014	T; F	
6	Devoll Hydropower	23X--150409-DHP5	11.06.2015	T; F	
8	Energji Ashta	54X-HECASHA-059	25.05.2012	P	
9	Energy Supply-AL	54X-ES-AL -- 12Y	25.02.2022	T; F	
11	GEN-I Tirana	23X---120709GEN0	31.01.2011	T; F	
13	Green Energy Trading Albania	23X--150702GE--3	01.07.2015	T	
14	Grupi Sistemeve Automatike	22XGSA-----N	09.05.2011	T; F	
15	Korporata Elektroenergjitike Shqiptare	23X--130918APC-M	25.04.2011	P; T	
16	KURUM International	23X--131115KI--1	17.12.2013	P; T; F	
17	NOA Energy Trade	23X--150630-NE-6	10.03.2015	T; F	
18	Operatori i Sistemit të Shpërndarjes - OSSH sh.a.	54X-10101FT022OP	19.02.2020	SH	
19	Stravaj Energy	54X-STRAVAJ-E086	25.04.2014	P; T	
20	WENERG	54X-WENERG---10E	10.06.2015	P	
24	Energy Financing Team Tirana	54X-EFT-TIRANA-V	24.08.2017	T; F	
25	Alpiq Energy Albania	23X--141204AEA-T	29.04.2011	T; F	
26	URADRIN	54X-100ID101218J	10.08.2018	F	
27	Energia Gas and Power Albania shpk	23x-150309-LT-Y	22.10.2018	T; F	
28	RENRGY Trading Group	54X-10IRN102618R	12.11.2018	T;F	
29	Ener Trade shpk	54X-10 IET091118	21.12.2018	T; F	
30	Power and Gas Operations	54X-10IPG2307196	23.07.2019	T	
31	ENSCO Trading (Albania) sh.p.k	54X-110IESA1019G	02.12.2019	T	
32	KESH sh.a	23X--130918APC-M	16.12.2019	F	
33	Furnizuesi i Tregut të Lirë - FTL sh.a.	54X-10101FT0220P	19.02.2020	T; F	
34	Furnizuesi i Shërbimit Universal - FSHU sh.a.	54X-0101IFSH022Q	19.02.2020	F	
35	EZ-5 Energy shpk	54X-11LKE250319U	25.03.2019	T;F	
35	Hec Arsti shpk	54X--10IH11A-IJ	27.03.2021	P	
36	Hec Lajthiza Invest	54X-L-1011LTF-1S	15.03.2022	P	
37	Danske commodities Albania	23X--121120DCALG	30.10.2012	T	
38	Lëngarica & Energy shpk	54X-L-1010H-LENU	09.07.2021	P	
39	INFO-TELECOM	54X-I-1100-INFTI	06.08.2021	T	
40	TIRANA INTERNATIONAL DEVELOPMEN	54X-I-0101-TID-F	06.08.2021	T	
41	TEODORI 2003	54X-L-110-TE-ALU	13.08.2021	P	
42	DITEKO sh.p.k	54X-L-10101DIT-Y	13.09.2021	T	
43	S.P.E. GJADER sh.p.k	54X-L-1010-GJADJ	18.10.2021	P	
44	AlbESP Trading & Consulting sh.p.k	54X-I-1010IAESPF	17.12.2021	F;T	
45	HEC Tervoli sh.p.k	54X-I-21010IHTEI	23.12.2021	P	
46	HEC BISHNICA 1.2 sh.p.k	54X-I-1001IHB12W	23.12.2021	P	
47	ENERGAL sh.p.k	54X-I-1111EN-ALF	31.12.2021	P;T	
48	EURON ENERGY sh.p.k	54X-I-0111EU-ENB	31.12.2021	T;P	
49	Hydro-Seta sh.p.k	54X-I-1111HS-015	31.12.2021	P;T	
50	Alb-Energy sh.p.k	54X-I-0101A1-EN3	11.05.2022	T	
51	Dragobia Energy sh.p.k.	54X-I_111DRG-01W	12.07.2022	P; T; F	
52	Future Energy Trading and Exchange Dynamics shpk	54X-I-101FETED-J	27.06.2022	F;T	
53	Ada Solar SE shpk	54X-I-01001ADS-6	26.04.2022	T	
54	Tren Sun System	54X-10-I-TSS-103	22.08.2022	P	
55	Korça Photovoltaic Park	54X-I-KOPP-11011	22.08.2022	P	
56	NTSP	54X-11-I-NTSP-12	22.08.2022	P	
57	Sun Beat System	54X-I-1011-SBS-V	22.08.2022	P	
58	Hidropower Electric	54X-I-101HE1011B	26.08.2022	T;P	
59	M&K Energy Trading Co	54X-L-11010MK-1S	06.08.2022	T	
60	Erdy Energy	54X-L-101ERDY-EZ	13.09.2022	P	
61	Albanian Green Energy	54X-I---1011AGEF	05.10.2022	P;T;F	
62	Balkan Green Energy	54X-I00001BGE--R	05.10.2022	P;T	
63	Favina I	54X-L-11FAV0101R	06.10.2022	P	
64	HEC Qarr&Kaltanj	54X-L-10HQARR10G	06.10.2022	P	
65	Osoja HPP	54X-L-101OSQJ-1R	06.10.2022	P	
66	Snow Energy	54X-I10101SNE--I	06.10.2022	P;T	
67	Energy 24	54X-I-1011EN-248	12.10.2022	T	
68	Erdat Lura	54X-HEC-LURA-069	12.10.2022	T	
69	Gjo-Spa Power	54X-HEC-LAPAJ075	12.10.2022	T	
70	Power Elektrik Slabinje	54X-I-1010PESLAV	12.10.2022	T;P	
71	HydroEnergy	54X-I1011HEN-10Y	18.10.2022	T	
72	Koka & Ergi Energy Stavec	54X-1010IHSTAV1Z	18.10.2022	P	
73	EZ-5 Energy	54X-11LKE250319U	02.11.2022	P	
74	HEC Vlushe	54X-I-H-VLE-1018	02.11.2022	T	
75	NRG Power	54X-L-110-NRG-PW	02.11.2022	F;T	
76	HEC Vlushe	54X-I-H-VLE-1018	04.11.2022	P	
					Source TSO company

Figure 75 Market Participants during 2022

Source TSO company

2.1.4 Recommendations for the market operators and participants from the monitorings

During 2022 in the framework of exercising the monitoring operation from ERE, for the market operators and participants are issued the recommendations and obligations as follows:

Full implementation of the Rules for the publication of the basic data of the Electricity Market, approved with ERE Board Decision no. 118, dated 27.07.2017, from the TSO company and OSHEE Group company within the increase of the transparency level in the electricity market;

Rigorous implementation of ERE Board Decisions no. 106, dated, 02.07.2020 “On approving the Albanian Electricity Balancing Market Rules”, from the involved TSO and the guarantee of its financial neutrality as defined on these rules;

The implementation of full criteria for OSHEE Group allocation, in three licensed DSO, FSHU and FTL companies, including their reporting form of the data at ERE according to the allocation;

The taken of the measures from TSO, OSHEE GROUP company and KESH company for full implementation of the provisions of the Regulation for Cybersecurity of Critical Infrastructure in Power Sector with ERE Board decision no. 126 dated 30.07.2020.

Shall be evidenced that ERE, implementing the provisions of point 5, letter a) of Decision no. 134/2018 “On approving the guideline for periodic annual monitoring”, prepared and submitted to the Albanian Parliament the reports and six-month information for the findings from the monitoring, where there are reported the main data for the situation of the Albanian Power System and the findings from the reports and monitorings of the participants as well as energy operators.

2.2 Regulation on wholesale energy market integrity and transparency (REMIT)

With ERE Board Decision no. 126, dated 17.05.2021, it is approved the Regulation for the Wholesale Energy Market Integrity and Transparency (REMIT). This regulation transposes the REMIT Regulation no. 1227/2011 as approved and adopted for the Contracting Parties of Energy Community and aims to define the criteria that prevent the abusive practices that may happen and affect the wholesale energy market. At the same time the regulation helps the proper operation of these markets considering their specific characteristics.

2.2.1 Obligations deriving from the Regulation on Wholesale Energy Market Integrity and Transparency (REMIT)

The Regulation on Wholesale Energy Market Integrity and Transparency, prohibits the energy trading from internal persons of the companies. This is due to the fact that these persons possess internal information regarding the energy products that shall be traded and as consequence the inclusion of these persons in trading energy products may prevent competition, transparency and distorts the energy market.

2.2.2 Monitoring and registration of the participants in the market implementing REMIT regulation

ERE shall monitor the commercial activity of the wholesale energy products to detect and prevent trade based on the flow of internal information and national market manipulation.

ERE shall cooperate at regional level through the Energy Community Regulatory Board in conducting wholesale energy markets monitoring. For wholesale energy market monitoring, ERE shall also cooperate with the Competition Authority, or any other body for market monitoring. In conducting market monitoring, the Competition Authority or the body of market monitoring shall have the same rights and obligations as ERE

Market participants entering into transactions with wholesale energy products in Albania, or show interest to enter into such transactions through the trading procedures, shall be registered at ERE.

2.2.3 Registration of market participants according to REMIT

During 2022 ERE, implementing REMIT regulation established a specific part on its website at the “Energy Market” session. On this item are found the respective documents of the regulation including Annex A on which it is respectively submitted Form 1, this form shall be used to submit the Information from ERE to Energy Community Regulatory Board (ECRB) in case of doubts for abusive influences to the Contracting Parties based on article 4(1) of ECRB, procedural act 01/2020, as well as Form 5 which shall be used to establish a national register of market participants that shall be published.

The main focus of ERE work for this year has been in preparing the National Register of REMIT in Albania, that is published on ERE website. As follows there is the REMIT register established during 2022:

Legal form	Address of the Company (Headquarters)	Country where the company is located	ZIP Code	EIC Code of the Company	BIC Code of the Company	LEI Code of the Company	NIPT of the Company	Website of the company	Webpage where are published the internal information
SHPK	Njesia Bashkiake Nr.5 Rr. Ibrahim Rugova 64.	Tirane	1019	22XGSA-N	SGSBALTX		J61820031J	www.gsa.al	www.gsa.al
SHPK	Ish-Noli Business center, Rr. Ismail Qemali Nr. 27	Tirane	1000	23X--120709GEN0	SGSBALTX		K81413005A	https://www.gen-i.eu/at/en/	https://www.gen-i.eu/at/en/
SHPK	Rruga "Vaso Pasha" Nr. 20	Tirane	1001	54X-1-10101AESPF			M122210081	www.albesptc.al	www.albesptc.al
SH.A	Rruga "Viktor Eftimiu"	Tirane	1023	23X-130918APC-M	SGSBALTX		J61817005F	www.kesh.al	www.kesh.al
SHPK	Bulevardi "Deshmoret e Kombit" Kullat binjake kati 2	Tirane	1001	23X-150630-N-6			L42203031A	www.noaenergy.al	
SH.A	Autostrada Tirane-Durres KM 9 Kashar	Tirane	1051	10XAL-KESH J	SGSBALTX	K42101801N	K42101801N	www.ost.al	www.ost.al/te-dhena/
SHPK	Rruga "Faik Konica" Nr1 Pallati kuq perball fakultetit ekonomik	Tirane	1001	54X-1-1100-INFTI	SGSBALTX		K92402002P	www.infotelecom.al	
SHPK	Rruga "Dervish Hima" NR1 Tirane	Tirane	1010	54X-101RM102618R				www.rnrgy.com	www.rnrgy.com
SHPK	Rruga "Sami Frasheri" Nr5, shkalla	Tirane	1001	54x-1-0101-TID-F	PUPPALTR		J82427007R		
SHPK	Rruga e Elbasanit, Objekti Park Gate, Kati 1	Tirane	1001	54X-101ET0911180	USALALTR	8945000X1HJLANDKZY22	L82118017S		https://www.linkedin.com/company/ener-trade-

Figure 76 Register of Market Participants according to REMIT 2022

3. ALBANIAN POWER EXCHANGE (ALPEX)

Based on Council of Ministers Decisions, respectively decision no. 322, dated 15.05.2019 "On the establishment and defining the legal form of the ownership structure of the shareholder capital for the market operator" and decision no. 609, dated 11.09.2019 "On defining the criteria and procedures for the selection of the participants on the shareholder capital of the market operator", on October 2020 was established the Albanian Power Exchange (ALPEX) as a Shareholder Company, in joint ownership of the Transmission System Operators of Albania (TSO) and Kosovo (KOSTT).

Albania and Kosovo have signed the Energy Community Treaty Agreement on October 2005, which is still effective initially for a 10-year period from July 2006 until on 2026. The main purpose of Energy Community is that through the framework of legal obligations to extend the standards of the regulations and the internal principles of the European Union energy market in the SouthEast Europe, in Black Sea region and beyond through an obligatory legal framework established from a series of *acquis* in energy, environment and competition.

Law no. 43/2015 "On Power Sector", as amended, abrogates the sole purchase model in the wholesale market, by submitting a free and multi-segmented market. The new market model, as defined on Council of Minister Decision no. 519 dated 13.07.2016 "On approving the electricity market model" including the day ahead market, within day market, the balancing and ancillary services market, as well as bilateral contracts market, being in conformity with the practices followed in many European Union countries. Also, the "Power Sector Law", ensures the establishment of the Power Exchange for the electricity organized market operation in Albania.

On 27 April 2016, to comply with the objectives of the third legislative package in electricity area of EU for the establishment of the European electricity internal market and based of the decisions taken on Western Balkans summit, held in Vienna on 27 August 2015, Albania and Kosovo engaged for the establishment of the operators (exchanges) for the operation and the day ahead market coupling (DAM) and intra day market (IDM) in a regional market.

On June 2018 the transmission system operators TSO, KOSTT, the Regulatory Entities ERE and ZRrE signed the understanding memorandum for the electricity day ahead market coupling.

Based on Power Sector Law, the Albanian Government approved on July 2016 the Electricity Market Model, which defined the roles and responsibilities of the different interest parties on the organized day ahead and intra day markets, while on December 2017 the Energy Regulator Authority (ERE) approved some specific rules regarding the way of organized market operation.

On December 2020 the Energy Regulatory Office in Kosovo (ZrE) approved KOSTT request to delegate to ALPEX the authority for the day ahead and intra day market organization for the market in Kosovo. While ALPEX opened on 6 May 2021 its branch in Prishtina that will focus the management of the market participants for Kosovo, other regulatory issues etc.

On the same line with the WB6 Understanding Memorandum, dated 21 October 2021 was signed another Framework Agreement between TSO, KOSTT, ERE and ERO for the day ahead and intra day market coupling. Albania and Kosovo signed the Framework Agreement as well as other successful agreements, necessary for the operation of the day ahead and intra day market coupling.

Based on the above, ALPEX is expected to operate on the organized electricity market (of the day ahead and intra day market) in Albania and Kosovo, shall organize the electricity market coupling between Albania and Kosovo, and to facilitate the coupling with the other markets of neighboring countries in conformity with EU regulations of the electricity market and the targeted European Model.

3.1 The steps undertaken regarding the initiation of the Albanian Power Exchange ALPEX and its operational rules

On 29 September 2022 ALPEX licensed from ERE for Electricity Market Operator Activity License no. 525, Seria 022, for a 5-year period.

On October 2022, ALPEX organized a workshop with some second level banks and the Bank of Albania, regarding the clearing and settlement model that shall be applied.

On 26 October 2022, ALPEX applied to receive the observer status to the Sole Day Ahead Market Coupling (SDAC), at ENTSO-E, as a necessary step to be a full right member at SDAC which is a request to be attached to the European Markets.

With Decision no. 272, dated 27.10.2022, ERE Board decided “To initiate the procedure for approving the electricity market rules (ALPEX rules, its definitions, trading procedures as well as clearing and settlement procedures. With the initiation of the procedure on date 24.11.2022 was held a common hearing session between the Albanian, Kosovo Regulators as well as the interested parties to issue opinions in the framework of the public consultation procedure of these rules.

Referring to the Framework Agreement on electricity market coupling of Albania and Kosovo, of date 21.10.2021, was signed by Energy Regulator Authority of Albania (ERE), the Energy Regulator Office of Kosovo, the Transmission System Operator of Albania (TSO company) and the Transmission and Market System Operator of Kosovo (KOSTT company), where it is provided that the Regulators shall be coordinated on the same time to approve the terms, conditions or methodologies.

On these conditions ERE according to Articles 16; 18, point 1, letter “a” and “dh”; Article 19 letter “a”, Articles 57 and 98 of Law no. 43/2015, “On Power Sector”, as amended, Council of Minister Decision no. 519, dated 13.07.2016 “On approving the electricity market model” as well as Article 26 of the “Regulation on ERE organization, operation and procedures”, approved with ERE Board Decision no. 96, dated 17.06.2016; ERE Board on their meeting dated 27.12.2022, with Decision no. 347, dated 27.12.2022 decided to approve the electricity market rules (ALPEX Rules definitions, the trading procedures and well as the clearing and settlement procedure).

As evidenced even above, the meeting for approving these rules was coordinated and realized jointly with the Kosovo Regulator.

ALPEX rules compose of these main parts provided as follows on this report:

ALPEX Rules – General Terms: These Rules define the specific details about which ALPEX, as the Market Operator, shall perform its obligations and according to the Exchange Members shall trade to the Albanian Electricity Exchange. Above all these rules include: The establishment of the internal organizational units and the structures of ALPEX regarding market monitoring, the surveillance and the report, its duties and competences as well as the respective procedures for their operation.

The definition of the rights and obligations of ALPEX and the Exchange Members. The provision of the requirements and conditions to be accepted as Exchange Member, and following the organizational and infrastructure requirements of the Exchange Members.

The handling of the procedural actions from ALPEX in non-compliance cases of the obligations from Exchange members. Clear definition of the procedures for suspension, withdrawal and termination of the membership as well as defining the announcements and communications approach between the parties. As well as of the actions undertaken by ALPEX in non-compliance cases and the force majeure as well as the provision of the procedures for dispute settlement between ALPEX and the Exchange Members.

Trading procedures: This part of the rules above all defines the handling of ALPEX trading segments, concretely the addition of the segment for the intra day market bids. The definition for the type of Auctions and the way of giving the results for the respective auctions. The addition of the products, and their specifications for various segments of the market, clear definition of the order-books, their types and content, delivery, assessment, validity, their acceptance, as well as the cancellation of the order-books.

Defining the bidding model from the Exchange Members on the basis of price – quantity couple. The clear definition of Transactions and Contracts concepts. The presentation and the set of the trading border and its effects. The increased number of the Portfolio and defining their types depending to the members requirements.

Detailed description of the products and the operation of the continuous trading segment within for the intraday.

Provision of alternative procedures for the day ahead market and/or the auction market for the intraday, if there exist the circumstances that do not permit the Market Coupling operation. As well as the provision of the concept for holding a second auction for the provided cases. The communication between the TSO and ALPEX for the exchange of necessary data and the respective terms.

Clearing and Settlement Procedure: At the document for Clearing and Settlement Procedure it is submitted a model which is currently implemented by the Service Provider. The main features of this draft procedure are listed as follows: The Clearing and Settlement Procedure Document defines the activity conditions of the Clearing and Settlement of the transactions for wholesale electricity sale and purchase in ALPEX markets, including in this process the bank system.

The Clearing and Settlement activity is performed through an electronic platform. The Clearing is performed by ALPEX in cooperation with the participants in the exchange.

ALPEX Definitions: This document defines the terminology which shall be used by ALPEX Power Exchange, as well as ALPEX shall inform about the updates regarding the enhancement of terminology according to the definitions of the documents of the guidelines in the European markets. It is emphasized the clear reflection of the used terminology used during the draft of these rules.

On November 2022, ALPEX officialized the initiation of the training procedure through the trading platform for training purposes to guarantee the secure initiation of the Albanian Power Exchange. This training shall last until the end of March 2023 enabling ALPEX the role of the Market Operator as well as other potential members of the market to participate on a trading environment to benefit the appropriate knowledges regarding the approach of bidding in the organized electricity market as well as the result of this process in a real environment.

On 01 February 2022, ALPEX is accepted as an Associated Member at the European Power Exchange Organization (EUROPEX), that is an important organization in policy making in the trading area of energy and natural gas.

4. LICENSING AND SUPERVISION AND THE ISSUE OF THE AUTHORIZATIONS OF THE LICENSEE ACTIVITIES IN THE POWER SECTOR

4.1 Licensing and applications handled by ERE during 2022 period

During 2022 ERE reviewed all applications submitted from the entities for licensing in various activities of power and natural gas sector, implementing the effective legal and by-legal framework.

For all submitted applications, it is respected the transparency provided on the licensing procedures, pursuant to Law no. 43/2015 "On Power Sector", as amended, Law no. 102/2015 "On the natural gas sector", as amended as well as the "Regulation on the Procedures and Terms for License Issue, Modification, Transferring, Renewal or License Termination on Power and Natural Gas Sectors", as recently amended with ERE Board Decision no. 220 dated 01.09.2022 and the "Regulation on the procedures and terms on license issue, modification, transferring or license removal on natural gas sector". According to the mentioned legal framework, the terms for publication in the print media to obtain the opinion of the interested parties have been implemented. Also, each license application was subject to the legal, administrative, financial, technical documentation assessment and to receive the respective permissions of using the water and environmental permissions, data from other institutions in conformity with the activities that the entities required to be licensed.

4.2 License in electricity production activity

On the above table are listed the entities licensed by ERE, during 2022, in electricity production activity. On this table are evidenced the data such as the installed capacity of the generation unit and the number of ERE decisions for licensing the entity. During 2022 are licensed in electricity production activity 22 entities and the innovation for this year has been the high number of the applications and as consequence the licensing in electricity production activity from the Photovoltaic plants mainly located on Fier area.

No.	Entity	Electricity producers	Installed capacity	ERE decision
1.	"BREÇANI - R.O.S.P" company	"Drita" HPP	1980 kW	Decision no. 9, dated 21.01.2022
2.	"LAJTHIZA INVEST" company	"Qami 1" HPP	1730 kW	Decision no. 40, dated 10.03.2022

3.	"AGE KUÇ" company	"Kuç" HPP	1930 kW	Decision. 41, dated 10.03.2022
4.	"HEC TERFOJA" company	"Terfoje" HPP	1980 kW	Decision no.59, dated 31.03.2022
5.	"ECO - ELB" company	Generation plant of urban wastes processing	2850 kW	Decision no. 92, dated 28.04.2022
6	"VOKOPOLA ENERGI" company	"Vokopola 1" HPP "Vokopola 2" HPP "Vokopola 3" HPP	274 kW 3104 kW 2297 kW	Decision no. 161, dated 17.06.2022
7	"Egnatia Hydropower" company	"Gostima 1" HPP "Gostima 2" HPP "Gostima 3" HPP "Gostima 4" HPP "Gostima 5" HPP "Gostima 5/1" HPP "Gostima 6" HPP	3047 kW 5586 kW 5335 kW 7396 kW 10321 kW 450 kW 16819 kW	Decision no. 248, dated 29.09.2022
8	"KESH" company	Photovoltaic Plant of Qyrsaqi Dam, Vau i Dejës	5143 kW	Decision no. 62, dated 11.04.2022
9	"KARAVASTA SOLAR" company	Photovoltaic Plant Remasit – Karavasta area, Lushnjë and Libofshë, Fier	140 000 kW	Decision no. 97, dated 09.05.2022
10	"SPV BLUE 1" company	Photovoltaic Plant Blue 1, Sheq Marinas	50 000 kW	Decision no. 116, dated 24.05.2022

11	"NTSP" company	Photovoltaic Plant Bitinckë area, Bilisht, Korçë	2000 kW	Decision no. 190, dated 21.07.2022
12	"KORÇA PHOTOVOLTAIC PARK" company	Photovoltaic Plant Bitinckë area, Bilisht, Korçë	2000 kW	Decision No. 191, dated 21.07.2022
13	"TREN SUN SYSTEM" company	Photovoltaic Plant at Bitinckë area, Bilisht, Korçë	2000 kW	Decision no. 192, dated 21.07.2022
14	"SUN BEAT SYSTEM" Company	Photovoltaic Plant Bitinckë area, Bilisht, Korçë	2000 kW	Decision no. 193, dated 21.07.2022
15	"GREEN ENERGY BILISHTI" company	Photovoltaic plant Bitinckë area, Bilisht, Korçë	2000 kW	Decision no. 194, dated 21.07.2022
16	"EZ-5 ENERGY" company	Photovoltaic plant Dërmenas area, Fier	10 000 kW	Decision no. 237, dated 22.09.2022
17	"ERNI SOLAR" company	Photovoltaic Plant Bilishtit area, Korçë	2000 kW	Decision no. 304, dated 25.11.2022
18	"CONSTRUCTION ENERGY PARTS (C.E.P)" company	Photovoltaic Plant Povelçë area, Fier	2000 kW	Decision no. 306, dated 30.11.2022
19	"HYDROPOWER" company	Photovoltaic Plant Povelçë area, Fier	2000 kW	Decision no. 307, dated 30.11.2022

20	“DIMAX ALBANIA” company	Photovoltaic Plant Povelçë area, Fier	2000 kW	Decision no. 308, dated 30.11.2022
21	“ALBSOLAR” company	Photovoltaic Plant, Bisht Kamzës, Administrative Unit Katund i Ri, Durrës Municipality	2000 kW	Decision no. 320, dated 12.12.2022
22	“BIGWIND” company	Photovoltaic Plant Darzezë, Dërmenas, Fier Municipality	2000 kW	Decision no. 332, dated 19.12.2022

Figure 77 Licensed entities, in electricity production activity for 2022

In total during 2022 the electricity production capacity from the licensed entities is 289.392 MW, from which 62.3 MW from hydro electricity production resources and 227.143 MW from photovoltaic resources.

4.3 Licensing in electricity trading activity

During 2022 period ERE continued to license the entities in electricity trading activity. On the following table are submitted the entities licensed by ERE in electricity trading activity. As evidenced for 2022 period are carried out 16 licenses from ERE in electricity trading activity.

No.	Entity	Licensed Activity	Date of ERE Board Decision Bordit
1	"ADA Solar SE" company	Trading	Decision no. 53, dated 29.03.2022
2.	"HEC TERFOJA" company	Trading	Decision no. 60, dated 31.03.2022
3.	"M.C INERTE LUMZI" company	Trading	Decision no.79, dated 13.04.2022
4.	"Duferco Shqipëria" company	Trading	Decision no. 125, dated 31.05.2022
5	"Salillari Energy Trade" company	Trading	Decision no. 168, dated 28.06.2022
6	“NRG Power “company	Trading	Decision no. 181, dated 13.07.2022

7	"ALB - ENERGY" company	Trading	Decision no. 182, dated 02.12.2021
8	"M & K ENERGY TRADING CO" company	Trading	Decision no. 200, dated 03.08.2022
9	"Egnatia Hydropower" company	Trading	Decision no. 238, dated 22.09.2022
10	"Cosmogral" company	Trading	Decision no. 257, dated 10.10.2022
11	H&K @ Vala Mar Residences	Trading	Decision no. 275, dated 27.10.2022
12	"IDRO ENERGIA PULITA" company	Trading	Decision no. 288, dated 10.11.2022
13	"HYDRO ENERGY SOTIRA" company	Trading	Decision no. 289, dated 10.11.2022
14	"HYDROPOWER" company	Trading	Decision no. 300, dated 18.11.2022
15	"H & E ENERGY" company	Trading	Decision no. 331, dated 19.12.2022
16	"Alb Energy Trade" company	Trading	Decision no. 349, dated 28.12.2022

Figure 78 Licensees in Electricity Trading activity during 2021

At the same time during 2022 are submitted at ERE 6 requests for license renewal of electricity trading activity due to the termination of the 5- year term and are approved the licenses as follows:

The renewal of "Danske Commodities Albania" company license, no. 374, Series T12/T17/T22, in electricity trading activity, approved with ERE Board Decision no. 94, dated 04.07.2017 and renewed with Decision no. 150, dated 10.06.2022, for a 5-year period.

The renewal of "PPC Albania" company license, no. 373, Series T17/T22, in electricity trading activity, approved with ERE Board Decision no. 93, dated 04.07.2017 and renewed with Decision no. 203, dated 10.08.2022, for a 5 – year period.

The renewal of "Enegy Financing Team Tirana" company license, no. 377, Series T17/T22, in electricity trading activity, approved with ERE Board Decision no. 119, dated 27.07.2017 and renewed with Decision no. 127, dated 31.05.2022, for a 5 – year period.

The renewal of "ALBPETROL" company license, no. 381, Series T17/T22, in electricity trading activity, approved with ERE Board Decision no. 140, dated 06.09.2017 and renewed with Decision no. 224, dated 06.09.2022, for a 5 – year period.

The renewal of "BINDI" company license no. 387, Series T17/T22, in electricity trading activity, approved with ERE Board Decision no. 170, dated 26.10.2017 and renewed with decision no. 236, dated 22.09.2022, for a 5-year period.

The renewal of "Smart Trade & Consulting" company license, no. 389, Series T17/T22, in electricity trading activity, approved with ERE Board Decision no. 173, dated 26.10.2017 and renewed with ERE Board Decision no. 235, dated 22.09.2022, for a 5 – year period.

4.4 Entities licensed in electricity supply activity

During 2022 ERE continued to license the entities in electricity supply activity. On the table as follows is the list of the entities licensed by ERE in electricity supply activity, which for 2022 are 5 companies.

No.	Entity	Licensed Activity	Date of ERE Board Decision
1	H&K @ Vala Mar Residences	Supply	Decision no. 163, dated 20.06.2022
2	"Salillari Energy Trade" company	Supply	Decision no. 168, dated 28.06.2022
3	"NRG Power" company	Supply	Decision no. 199, dated 03.08.2022
4	"Alb Energy Trade" company	Supply	Decision no. 303, dated 25.11.2022

Figure 79 Licensed entities in electricity supply activity during 2022

During 2022 at ERE are submitted 5 requests for license renewal in electricity supply activity due to the termination of the 5-year period and are approved as follows:

The renewal of "KURUM INTERNATIONAL" company license, no. 372, Series F12/F17, in electricity supply activity, approved with ERE Board decision no. 126, dated 28.10.2013, and renewed with ERE Board Decision no. 145, dated 06.06.2022, for a 5-year period.

Renewal of "Albanian Green Energy" company license, no. 376, Series F17/F22, in electricity supply activity, approved with ERE Board Decision no. 114, dated 27.07.2017, and renewed with ERE Board Decision no. 157, dated 17.06.2022, for a 5-year period.

Renewal of the "ALBPETROL" company license, no. 382, Series T17/T22, in electricity trading activity, approved with ERE Board Decision no. 141, dated 06.09.2017 and renewed with Decision no. 225, dated 06.09.2022, for a 5-year period.

Renewal of "Enegy Financing Team Tirana" company license no. 390, Series F17/F22, in electricity supply activity, approved with ERE Board Decision no. 174, dated 26.10.2017 and renewed with ERE Board Decision no. 126, dated 31.05.2022, for a 5 – year period.

Renewal of "Eneji Ashta" company license, no. 395, Series F18/F23, in electricity supply activity, approved with ERE Board Decision no. 26, dated 30.01.2023 and reviewed with Decision no. 340, dated 21.12.2022, for a 5-year period.

4.5 Licensing of the Albanian Power Exchange ALPEX company

A new development on ERE decisions for 2022, was the licensing of the “Albanian Power Exchange – ALPEX”, in electricity market operation activity, with ERE Board decision no. 247, dated 29.09.2022.

The Albanian Power Exchange - “ALPEX company, is established according to Law no. 43/2015 “On Power Sector” as amended, Law no. 9901, dated 14.04.2008, “On entrepreneurs and companies” as amended, Council of Minister Decision no. 519, of date 13.07.2016, "On approving the electricity market model"; Council of Minister Decision no. 609, dated 11.09.2019 "On defining the criteria and procedures of selecting the participants for the share of the market operator. This enterprise shall operate on the Electricity Albanian Market and also opened its affiliate even in Kosovo, according to Decision no. 1, dated 27.01.2021 “On approving the opening for the Electricity Power Exchange affiliate in Kosovo”.

4.6 Licensing in Natural Gas activity

During 2022, ERE has not approved licensing processes and there have not been licenses modification in natural gas sector.

4.7 Qualification and equipment with the Guarantee of Origin Certification during 2022

During 2022 ERE handled some requests and took 1 (one) decision for qualification and equipment with the Guarantee of Origin Certificate for 3 (three) electricity generation plants. On the table as follows are issued the data regarding the plants equipped with the Guarantee of Origin.

No.	Entity	Plant	Qualificati on/ issue GO	Date of ERE Board Decision
1	“DEVOLL HYDROPOWER” company	Banjë HPP	GO equipment	Decision no. 47, dated 23.03.2022
2	“DEVOLL HYDROPOWER” company	Moglicë HPP	Plant qualification and GO equipment	Decision no. 64, dated 11.04.2022
3	“KORPORATA ELEKTROENERGJITIKE SHQIPTARE” (KESH) company	Photovoltaic Plant of Qyrsaqit Dam Vau i Dejës	Plant qualification	Decision no. 187, dated 21.07.2022

Figure 80 Plants equipped with the Guarantee of Origin for 2022

4.8 Issue of authorizations from ERE during 2022

During this year at ERE implementing the effective legislation are taken the decisions as follows for issuing the authorizations as follows:

With ERE Board Decision no. 119, dated 24.05.2022 it is approved the request of “IRARBA ENERGJI” company for transferring the immovable assets in favour of BANKËS SË BASHKUAR TË SHQIPËRISË.

With ERE Board Decision no. 153, dated 13.06.2022 it is approved the issue of authorizations from ERE for amending the partner that controls the interests of “AlbEsp Trading & Consulting” company.

With ERE Board Decision no. 154, dated 13.06.2022 it is approved the issue of authorization from ERE for amending the partner that controls the interests of “HEC-i KABASH POROCAN” company.

With ERE Board Decision no. 171, dated 28.06.2022 it is approved the issue of authorizations from ERE for amending the partner that controls the interests of “M.T.C ENERGY” company.

Also, during this year ERE reviewed also other requests of the licensees, for which it is decided not to open the procedure or to refuse the issue of approval due to the applicant have not fulfilled the requirements of the legal and by-legal effective acts regarding the applications at ERE.

During this year at ERE are decided not to initiate the procedure for 4 (four) applications for licensing in production; 4 (four) applications for trading licenses; 5 (five) applications for license renewal; 2 (two) applications for license modification; 1 (one) application for license transferring. Also, it is approved the refusal for 7 (seven) applications for licensing into production activity; for 1 (one) application for license renewal; for 1 (one) application to receive the authorization for asset transferring.

Also, due to the failure of completing the application documents on time, ERE Board took 21 decisions for post-poning the administrative term of final decision regarding these applications.

Regarding the above, in the framework of completing the licensing conditions from the licensees, are taken 19 decisions to review these decisions.

During 2022, it is removed 1 (one) license in electricity trading activity due to failure to liquidate the regulatory payment; as well as 2 (two) licenses, one in electricity production activity and one in electricity trading activity, on the request of the licensees.

4.9 Supervision of licensees during 2022.

During 2022 the supervision of the licensees by ERE continued with the control and assessment of the information provided from the reports regarding the licensed activity of any entity.

Based on the obligations deriving from the licenses in Power and Natural gas activity there continued the periodic reports referring according to the terms defined for these reports.

According to the data collected from the metering records of the Free Market Supplier (FTL), they respond on time to any licensee that invoices the sold electricity according to the Free Market Supplier contract.

From the collected data are processed and analysed the technical – economic indicators for 2022 where according to the periodic evidences it results that the reporting entities have fulfilled their

expectations regarding the electricity production.

For the supervision of the licensees it is maintained and updated continuously the information received from the Safety Policy reports of employee health as well as of the immovable assets regarding the licensed activity. The issued conclusions show an engagement from the licensee to correctly comply the tasks deriving from the license that they possess.

Also, in the framework of the monthly report from some companies are evidenced the issues as result of the voltage fluctuatiions as well as electricity disconnection in the area where they operate. Regarding these cases ERE according to the “*New Connection Agreement*” approved with ERE Board Decision no. 166, dated 10.10.2016, “the *Distribution Code*” approved with ERE Board Decision no. 100 dated 26.08.2008, as well as the “*Regulation on the standard criteria of the quality of service and performance of the electricity distribution network safety*”, approved with ERE Board Decision no. 181 dated 10.11.2017, case by case addressed by the respective official letters to the network operators reminding them the completion of the tasks deriving from the abovementioned acts, as well as requiring information on the concrete actions that are undertaken to settle the encountered issues from the licensees. As observed and referring to the problems reported from the entities it is evidenced the need for attention added to the TSO or DSO companies on defined areas, which according to the network Operator are on the attention to be involved on the respective investment plans.

4.10 The annual compliance report of the Transmission System Operator for Electricity TSO company

Implementing the definitions of ERE Board Decision no. 43, dated 15.03.2017, “*On approving the final certification of “Transmission System Operator” for electricity TSO company in conformity with article 54, point 6, of law no. 43/2015, “On Power Sector” and article 9, point 6, of Directive 72/2009 EC after receiving the opinion of Energy Community Secretariat” as well as implementing the definitions of the Compliance Program of TSO company, approved with ERE Board Decision no. 103, dated 30.04.2018, the Compliance Officer of TSO company, in fulfilling its tasks, submitted at ERE the compliance report of TSO company for 2021 period.*

From this report it was observed that TSO company during 2021 performed a good job regarding the provisions of the certification decision, but there is still work to be done regarding the implementation of the compliance program and the implementation of the compliance officer recommendations. From ERE are issued some recommendations in the framework of the improvements to fulfill this task which shall be considered by TSO staff and shall be reported from the Compliance Officer during the report of the next year.

4.11 The annual Compliance report of the Electricity Distribution Operator, DSO company.

Following the Compliance Program of the Distribution System Operator (DSO company) approved with ERE Board Decision no. 257, dated 21.12.2020, are defined the conditions for the allocation and independence of the DSO company, implementing Law no. 43/2015, "On Power Sector" as amended with the official letter protocol no. 730/1, dated 01.03.2022, ERE protocol no. 166/1, date 05.04.2022, from the Distribution System Operator (DSO) is submitted the respective information regarding the implementation of this program. After reviewing this information, for DSO company was evidenced that the information shall be further completed and are let the respective recommendations.

Apart of the above, implementing Article 16 of Law no. 43/2015, "On Power Sector" as amended; as well as point 1.2 and point 2 of the Compliance Program, approved with ERE Board Decision no. 250, of date 21.12.2020, with Decision no. 343, of date 21.12.2022, it is approved the Contract for providing the services of the Compliance Officer of the Distribution System Operator, DSO company giving to the DSO company the task to submit at ERE for approval the Compliance Program after the approval from its governing bodies.

411 Compliance program of the Transmission System Operator of Natural Gas ALBGAZ company.

ERE Board, with Decision no. 345, dated 21.12.2022, decided the final approval of the *Compliance Program of the Transmission System Operator for Natural Gas, "ALBGAZ" company, by assigning the responsibility that "ALBGAZ company" shall implement the tasks deriving from the effective legal and bylegal acts, regarding:*

the relations of the shareholders of "ALBGAZ" company engaged in natural gas or electricity production and/or supply, or those that have any commercial interest (point 5 of the Compliance Program of "ALBGAZ" company)

the allocation and independence of the public bodies which are authorized to represent the rights of the state shares on one part and the companies engaged in production and supply on the other side (point 6 of the Compliance Program of "ALBGAZ" company)

412 The annual compliance report of the Transmission System Operator of Natural Gas ALBGAZ company.

Based on Law no. 102/2015, "On natural gas sector", as amended, the requests of the "Compliance Programme", approved with ERE Board Decision no. 77, dated 26.05.2017, "On approving the Compliance Programme of the Transmission System Operator for Natural Gas"; according to the obligations left out from ERE Board Decision no. 78, dated 26.05.2017, "On approving the contract for providing the compliance officer services in natural gas", The Compliance Officer of ALBGAZ company, with the official letter dated 31.03.2021, submitted the Annual Compliance Report for Albgaz company (Combined Operator of Natural Gas).

Referring to the officer report, regarding the implementation of the compliance programme for 2021 period, its findings and recommendations, it is evidenced that this report is generally performed according to the requests of the compliance program, and as follows there are left some tasks and recommendations that shall be taken into consideration on the periodic report of the Compliance Officer and ALBGAZ company itself.

5. ERE ACTIVITY IN TARIFF AND PRICES REGULATION OF POWER AND NATURAL GAS SECTORS

Implementing articles 19,20,79 and 83 of Law No. 43/2015 “On Power Sector”, as amended, and articles 16, 17, 32, 75 and 92 of Law 102/2015 “On Natural Gas Sector” as amended, as well as article 10 of Law 7/2017 “On the promotion of the use of energy from renewable resources”, ERE is the responsible authority for imposing the tariffs and prices for the regulated activities and those that have the public service obligation in power sector, based on the respective effective methodologies. Within this framework, ERE main activities in tariff and prices regulation of Power and Natural Gas sectors during 2022 have been:

Review of the applications, cost analysis and approve of tariffs and prices from the licensee in power and natural gas sectors for:

Electricity transmission activity;

Electricity distribution activity;

Supply activity from the electricity universal service supplier;

Supply activity from the supplier of last resort for electricity;

Natural gas transmission and distribution activities;

Defining the purchase price of electricity generated from small renewable resources from solar and from small renewable resources from the small generators with renewable resource from the biodegradable part of solar waste, utilising the industrial, urban and rural wastes;

Defining the average purchase price of electricity generated from photovoltaic plants with installed capacity up to 2 MW;

Defining the electricity sale price from the existing priority producers;

Indicators of production and income from the sale of electricity for the electricity priority producers;

Electricity purchase cost implementing the conditions for setting public service obligation from the licensees on power sector;

The drafting, review and approval of the Methodologies for calculating the tariffs for the licensees on power and natural gas sectors:

Approval of the Methodology for calculating the tariffs for the natural gas storage service.

Tariffs and prices approved by ERE over the years as well as electricity prices compared to the countries in the region.

During 2022, ERE has reviewed and assessed the costs of the activities of the regulated companies of the power and natural gas sector, as it has done for each exercise year in implementation of the legislation in force.

As highlighted in the 2021 annual report, during the second 6 months of 2021, the international energy market faced an increase in demand, while the electricity and natural gas supply could not meet the market's needs. The situation created at the international level derives significant effects on the Albanian electricity market as well. The Albanian Government through decision no. 584, dated 08.10.2021 announced the State of Emergency for Energy Supply, where, among other things, it decided to suspend the investment plans of "KESH" company, "TSO" company and "OSHEE" company in addition to the necessary investments for the exercise of the activity with the aim of guaranteeing uninterrupted electricity. The emergency for electricity supply continued throughout 2022, affecting the costs of the activities of regulated companies in the power sector.

The international electricity market was also affected by electricity prices traded on the day ahead market on the Hungarian Power Exchange HUPX DAM which realized an average price of 271.67 Euro/MWh for 2022.

In order to review the adequacy of electricity transmission and distribution tariffs, as well as considering the significant increase in the cost of purchasing energy in the free market, ERE continued with the review of the applications submitted by TSO company and DSO company. This process, which consisted in the calculation and evaluation of the average transmission tariff, electricity distribution tariffs and their accommodation in the electricity sale price to end-use customers, was finalized with the approval of the new tariffs for 2022.

The Albanian Government with decision no. 456, dated 29.6.2022, approved the conditions for establishing the public service obligation, which shall be applied to licensees in the power sector, who exercise the activity of production, transmission, distribution and supply of electricity. The public service obligation to the licensees in the power sector was established taking into consideration the public interest in the exercise of the activities of production, transmission, distribution and supply of electricity, among others for the conditions related to the security of supply, the quality of service, renewable energy sources, energy efficiency, tariffs and prices for customers who benefit from the public service obligation, etc. This decision also determined the necessary provisions for coping with the emergency situation in the electricity supply, based on the provisions of Law no. 43/2015, "On Power Sector", as amended.

5.1 Review of the applications for the approval of the tariffs and prices for the licensees in power and natural gas sectors for 2022

5.1.1 The application of TSO company to approve the electricity transmission service tariff for 2022 and for 2022-2024 period.

Transmission System Operator (TSO) Company with official letter Protocol no. 5215, dated 31.08.2021 submitted at ERE the application for the electricity transmission tariff for 2022 as well as for 2022-2024 period.

TSO company in the submitted application requested from ERE the approval of the average electricity transmission tariff for the 3-year period 2022 - 2024 in the amount of **1.47 ALL/kWh** from the current tariff of **0.75 ALL/kWh**.

In this context, ERE with decision no. 234, dated 19.11.2021, decided "to open the procedure to review the application of TSO company for the electricity transmission tariff for 2022 and 2022-2024 period".

ERE has constantly requested from TSO company to submit an application for the transmission tariff for a 3-year regulatory period, aiming at stability in network usage tariffs, a principle that is provided for in the Methodology for determining the electricity transmission tariff.

Pursuant to the "Regulation for ERE Organization, Operation and Procedures", during the process for reviewing the request of TSO company the necessary procedural actions were carried out to ensure transparency through publications and hearing sessions, as well as receiving opinions from the interested parties.

During this process, ERE continued with a series of correspondences with TSO company on handling the issues which have been necessary in order to be provided with further information, documentation and arguments which have been published on the official website of ERE.

The company in the application request for the electricity transmission tariff for 2022 and 2022-2024 period, presented updates of the costs of its activity, which were justified by the unusual situation of the increase in the price of electricity purchased on the free market in order to cover losses in the electricity transmission network.

During this process, the data and documents submitted were reviewed to calculate reasonable costs for the exercise of the Transmission System Operator's activity, based on Law 43/2015 "On power sector" as amended, as well as the Methodology for calculating electricity transmission tariffs" approved by ERE Board with decision no. 180, dated 08.11.2017.

At the end of this process, ERE Board with decision no. 72, dated 13.04.2022 decided on the approval of the electricity transmission service tariff for May 1, 2022 - December 31, 2024 period, of about **0.85ALL/kWh**.

5.1.2 Application of the Electricity Distribution System Operator for the determination of electricity distribution service tariffs

Based on Article 19, letter "c" of Law no. 43/2015, "On Power Sector", as amended, ERE is the institution responsible for the approval and publication, in accordance with the principle of transparency and taking into consideration the cost of the service provided, of the electricity distribution service tariffs as well as the approval of tariffs for licensed activities for which the public service obligation has been imposed.

Following ERE Board decision no. 233, dated 19.11.2021, for opening the procedure to review the application of DSO company tariffs for 2022, ERE requested DSO company that the application shall consider updating the data in accordance with the requirements of the Regulation "Regulation for ERE Organization, Operation and Procedures", approved with ERE Board decision no. 96, dated 17.06.2016, "Methodology for calculating the tariffs of the Distribution System Operator", approved with ERE Board decision no. 182, dated 10.11.2017 as well as Council of Ministers decision no. 584, dated 08.10.2021 "On declaring the state of emergency in the electricity supply", as amended.

DSO company has stated that from the calculations made with the updated information, the average electricity distribution tariff for 2022 is required to be 6.69 ALL/kWh. Distribution tariffs for voltage levels according to the updated calculations of DSO company are requested as follows:

Electricity distribution tariff for 2022 at 35 kV voltage of 2.62 ALL/kWh, from the current tariff of 1.5 ALL/kWh;

Electricity distribution tariff for 2022 at 20/10/6 kV voltage of 4.14 ALL/kWh, from the tariff of about 3.9 ALL /kWh that is currently in force for the 20 kV voltage level;

The electricity distribution tariff for 2022 at the 0.4 kV voltage is 7.37 ALL/kWh, from the average distribution tariff of 4.79 ALL/kWh in force, which has served for the 0.4 kV voltage level.

At the end of the review of the application submitted by DSO company together with all the supporting documentation submitted at ERE during the application review phase, ERE Board with Decision no. 73, dated 13.04.2022, decided on the approval of the electricity distribution service tariffs according to the voltage level, for May 1 - December 31, 2022 period, as follows:

Electricity distribution tariff for customers connected at the 35kV voltage level - 1.55 ALL/Kwh;

Electricity distribution tariff for customers connected at 0.6 voltage level - 20 kV -3.99 ALL/Kwh;

Electricity distribution tariff for customers connected at 0.4 kV voltage level - 6.42 ALL/Kwh;

Approval of the applicable price for reactive energy billing for May 1 - December 31, 2022 period of 1.92 ALL/kVarh.

Regarding the approval of electricity distribution service tariffs for 2023, ERE with Official letter Protocol no. 1472 dated 18.08.2022, requested the Distribution System Operator (DSO) company to submit the application for the determination of electricity distribution tariffs for the following year, accompanied by the information and documentation required according to the legal and by-laws in force.

DSO company has not submitted an application at ERE for the determination of electricity distribution tariffs for 2023 and therefore with the aim that DSO company also for 2023, can carry out the electricity distribution activity, in accordance legislation in force, ERE Board with Decision no. 324, dated 14.12.2022, decided to postpone the legal force of ERE board decision no. 73, dated 13.04.2022, until the adoption of a decision based on the application of DSO company for 2023 or ascertaining the change of costs based on the legal and by-laws in force. In the event that this decision shall have effects on the income of DSO company they shall be updated and compensated according to the provisions of Article 20, letter "c" of Law no. 43/2015, "On Power sector", as amended.

5.1.3 Review and approval of retail electricity prices for end-use customers served by Universal Service Supplier company

The Universal Service Supplier company did not submit at ERE an application for the approval of retail electricity sale prices for end-use customers served by the universal service supplier for 2022.

Found in the above circumstances, in order that the Universal Service Supplier company shall continue exercising the activity for which it is licensed even for 2022, in accordance with law no. 43/2015, "On Power Sector", as amended, ERE Board with decision no. 252, dated 21.12.2021, approved the postponement of the legal force of ERE Board decision no. 214, dated 15.12.2020, until ERE evaluation on the transfer of costs of electricity transmission and distribution of the retail prices of the end-use customers who are served by the Universal Service Supplier, in accordance with the requirements of the legal and by-laws in force.

In the absence of the company's application and cost estimates, which Universal Service Supplier company expected to perform for 2022, ERE carried out its evaluations regarding the effects of the transfer of electricity transmission and distribution costs on the retail prices of end-use customers served by the Universal Service Supplier for 2022 in accordance with the requirements of legal and by-law acts in force. In this process, the data from the reports of the Universal Service Supplier

company were also considered relevant and the calculations made by ERE for each year of the 2015-2020 period, which are also supported by the respective decision-making.

At the end of this evaluation, it was found that the average sale price of electricity of about 10.7 ALL/kWh is expected to recover all the costs of the universal service supply activity after the transfer of the costs of transmission, distribution and purchase of electricity for the universal service activity. Consequently, the prices approved by ERE for the Universal Service Supplier company were left into force in order to continue the normal activity of the Universal Service Supplier company.

Revenues realized above/below those allowed shall be corrected by ERE in accordance with the "Methodology on Defining the Retail Electricity Sale Price for the End-Use Customers Supplied from the Universal Service Supplier (USS) approved with ERE Board decision no. 189, dated 23.11.2017, at the time of submission of the application for revision of retail prices of the Universal Service Supplier company according to the provisions of the legislation in force.

5.1.4 Costs included in the calculation of the electricity retail price for household customers with consumption over 800 kwh per month

With official letter Protocol no. 6358, dated 20.09.2022, the Universal Service Supplier Company (USS) submitted at ERE the request for approval of the electricity sale price for consumption over 800 kWh/month for household customers. This request was justified with the increase in the cost of purchasing electricity that is procured for the purpose of covering the needs of the Universal Service Supplier Company from the Albanian Power Corporation, (KESH company), which by the decision of the General Assembly no. 6645/1, dated 08.09.2022, decided that the electricity price of household customers for consumption over 800 kWh/month is about 34.3 ALL/kWh.

In the above circumstances the Universal Service Supplier Company requested recognition of the cost of purchasing electricity for household customers who would consume over 800 kWh/month with a value of 1,820 million ALL, for October - December 2022 period, including other costs associated with the sale price of electricity for these customers. The company argued that the applicable price for consumption above 800 kWh/month for household customers would cover the costs of purchasing electricity, which decreased exponentially in the regional and European energy market. This proposal did not affect the sale price of electricity for household customers consuming up to 800 kWh/month as well as non-household customers, as the tariffs for the use of electricity transmission and distribution networks continued to be the same.

In the conditions where the company was expected to face an increase in the costs of purchasing electricity, as well as based on Law no. 43/2015 "On power sector", as amended, where its main purpose is to guarantee stable and safe supply of electricity to end-use customers, ERE considers it reasonable that: in addition to the recognized costs according to the Board's decision no. 74, dated 13.04.2022, to also recognize the additional costs of purchasing energy from the company charged with the public service obligation for the supply of electricity to customers who are supplied by the universal service supplier. The purpose of this decision was to maintain and ensure the liquidity necessary for the continuity of the electricity supply activity, based on the public service obligation.

ERE Board with decision no. 242, dated 23.09.2022, after evaluating the findings reflected in this decision, decided, among other things, to approve the electricity sale price of about 42 ALL/kWh for consumption over 800 kWh/month for household customers for 1 October - 31 December 2022 period.

Following this decision, the Universal Service Supplier has submitted at ERE according to the relevant correspondence, the update on the costs of purchasing electricity in order to cover the energy needs of end-use customers after the suspension of the application of electricity sales tariffs for the Universal Service Supplier company from KESH company based on the respective decisions of the General Assembly of the Shareholders of KESH company. The suspension of the effects brought as a result the need for successive changes of each month of the last 3 months of 2022, circumstances which led ERE Board to taking decision no. No. 323, Dated 14.12.2022 for the repeal of decision no. 242, dated 23.09.2022, "On the request of FSHU company regarding the costs that shall be included in the calculation of the retail price of electricity for household customers with consumption over 800 kwh per month"

5.1.5 Determination of electricity sale prices by the Supplier of Last Resort for 2022

Pursuant to Article 87, point 4 of Law no. 43/2015 "On power sector", as amended, as well as the "Methodology of determining the price of the sale of electricity from the Supplier of Last Resort", approved with Decision no. 201, dated 04.12.2017, amended by ERE Board decisions no. 144, dated 25.06.2018 and no. 233, dated 20.12.2019, the Energy Regulatory Authority has determined the sale price of electricity supplied by the Supplier of Last Resort (FMF) for each month of 2022, for the categories of customers as follows:

Customers connected at the 35 kV voltage level;

Customers connected to the 20/10/6 kV voltage levels, who from 01.01.2022 enter the unregulated market.

Calculations of electricity sale prices from the Supplier of Last Resort are made in accordance with the formula defined in the above-mentioned methodology.

For customers connected to the 35 kV voltage level

Below are presented in tabular form the sale prices of electricity supplied by the Supplier of Last Resort for customers connected at the 35 kV voltage level. Alongside them are reflected the respective decisions of ERE Board as well as the weighted average prices of electricity purchase to cover the energy demand of this category of customers. For comparison purposes, in addition to the data of 2022, the data of the previous year 2021 have also been reflected.

FMF 35 kV	DECISION	Electricity sale price approved by ERE (ALL/kWh) 2021	Weighted average price of electricity purchase (ALL/kWh) 2021	2022	DECISION	Electricity sale price approved by ERE (ALL/kWh) 2022	Weighted average price of electricity purchase (ALL/kWh) 2022
January	No. 38, Dated 11.02.2021	10.80	6.56	January	No. 75, Dated 13.04.2022	32.76	27.88
February	No. 71, Dated 12.03.2021	10.79	6.55	February	No. 76, Dated 13.04.2022	32.85	27.97
March	No. 103, Dated 16.04.2021	10.54	6.31	March	No. 77, Dated 13.04.2022	32.92	28.04
April	No. 119, Dated 11.05.2021	10.57	6.34	April	No. 105, Dated 19.05.2022	32.72	27.84
May	No. 133, Dated 07.06.2021	10.48	6.26	May	No. 148, Dated 10.06.2022	32.14	27.84
June	No. 161, Dated 12.07.2021	10.48	6.26	June	No. 173, Dated 07.07.2022	31.75	27.47
July	No. 179, Dated 23.08.2021	15.34	10.97	July	No. 207, Dated 17.08.2022	31.20	26.93
August	No. 182, Dated 10.09.2021	15.03	10.67	August	No. 229, Dated 12.09.2022	31.29	27.02
September	No. 213, Dated 15.10.2021	24.74	20.19	September	Nr. 261, Datë 14.10.2022	31.15	26.88
October	No. 229, Dated 09.11.2021	32.73	27.85	October	No. 287, Dated 10.11.2022	31.50	27.22

November	No. 246, Dated 13.12.2021	38.73	33.68	November	No. 318, Dated 12.12.2022	31.21	26.94
December	No. 16, Dated 26.01.2021	31.73	26.88	December	No. 318, Dated 12.12.2022	30.59	26.34
ANNUAL AVERAGE		18.50	14.04	ANNUAL AVERAGE		31.84	27.36

Figure 81 Sale prices and weighted average price of electricity supplied by Supplier of Last Resort for 35 kV
(Source: ERE)

As noticed in the table above, the weighted average price of electricity purchase to cover the demand of customers connected to 35 kV supplied by the Supplier of Last Resort, in contrast to the previous year, during 2022 did not show significant fluctuations. Its trend has continued to remain at levels similar to the last three months of 2021. The reason for the monthly price differences of 2022 below 2% has come as a result of providing the entire amount to cover the electricity demand for this category of customers only through two purchase procedures by the Universal Service Supplier company where the weighted average price of 230.57 Euro/MWh was 18% lower than the weighted average price of energy traded for the year 2022 in HUPX. Below is the moving curve of the weighted average price of electricity purchase for the purpose of supply of last resort for customers connected to 35 kV, for 2021 - 2022.

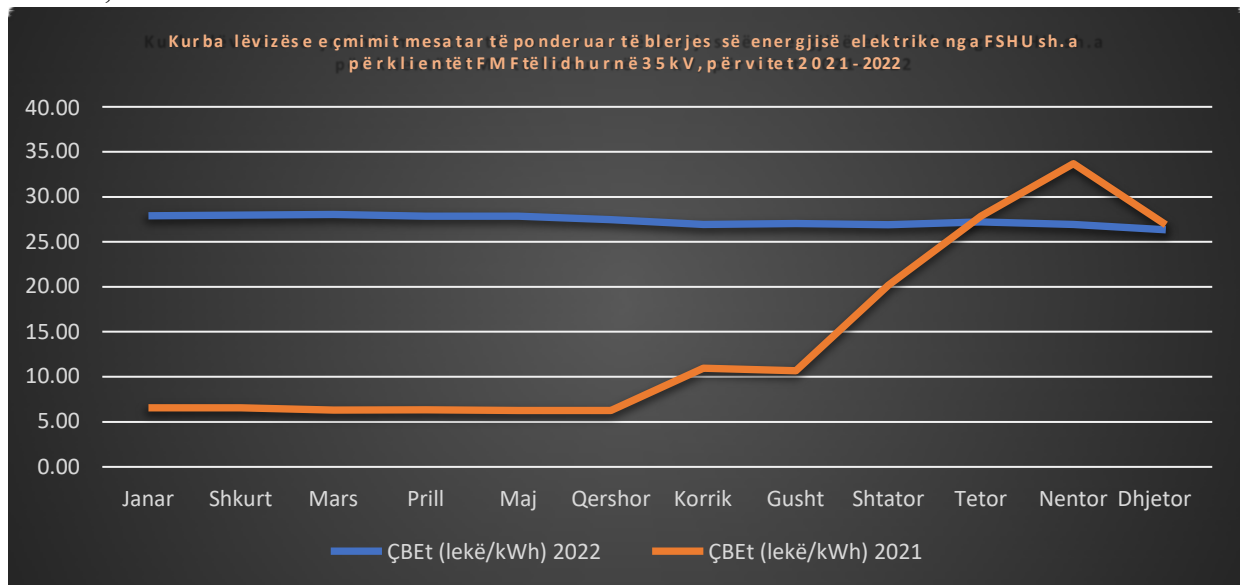

Figure 82 Moving curve of the weighted average price of electricity purchase from the Universal Service Supplier for customers connected at the 35 kV voltage level, which are supplied by the Supplier of Last Resort, for 2021-2022 (Source: ERE)

The graphic above clearly reflects the stability of the cost of purchasing energy throughout the months of 2022. The purchase price of electricity to cover the demand of the Supplier of Last Resort customers connected at 35 kV voltage level has undergone a significant increase compared to the previous year, as a result of the unusual dynamics of the energy markets in the region and beyond. Through the concrete data of the following table, the significant differences of these costs are easily evident, where the comparison of the weighted average of 2021 with the weighted average of 2022 results in an increase of 48.68%.

	Janar	Shkurt	Mars	Prill	Maj	Qershor	Korrik	Gusht	Shtator	Tetor	Nentor	Dhjetor	Mesatare
ÇBEt (lekë/kWh) 2022	27.88	27.97	28.04	27.84	27.84	27.47	26.93	27.02	26.88	27.22	26.94	26.34	27.36
ÇBEt (lekë/kWh) 2021	6.56	6.55	6.31	6.34	6.26	6.26	10.97	10.67	20.19	27.85	33.68	26.88	14.04
Diferenca në përqindje	325%	327%	344%	339%	345%	339%	145%	153%	33%	-2%	-20%	-2%	95%

Figure 83 Electricity purchase price from the Supplier of Last Resort to cover the needs of the Supplier of Last Resort (FMF) customers connected at the 35 kV voltage level for 2021 – 2022 period (Source ERE)

The graphic below presents the moving curve of electricity sale prices from the Supplier of Last Resort for customers connected at the 35 kV voltage level, approved by ERE Board for 2022, compared to the curve of the sale price for 2021:

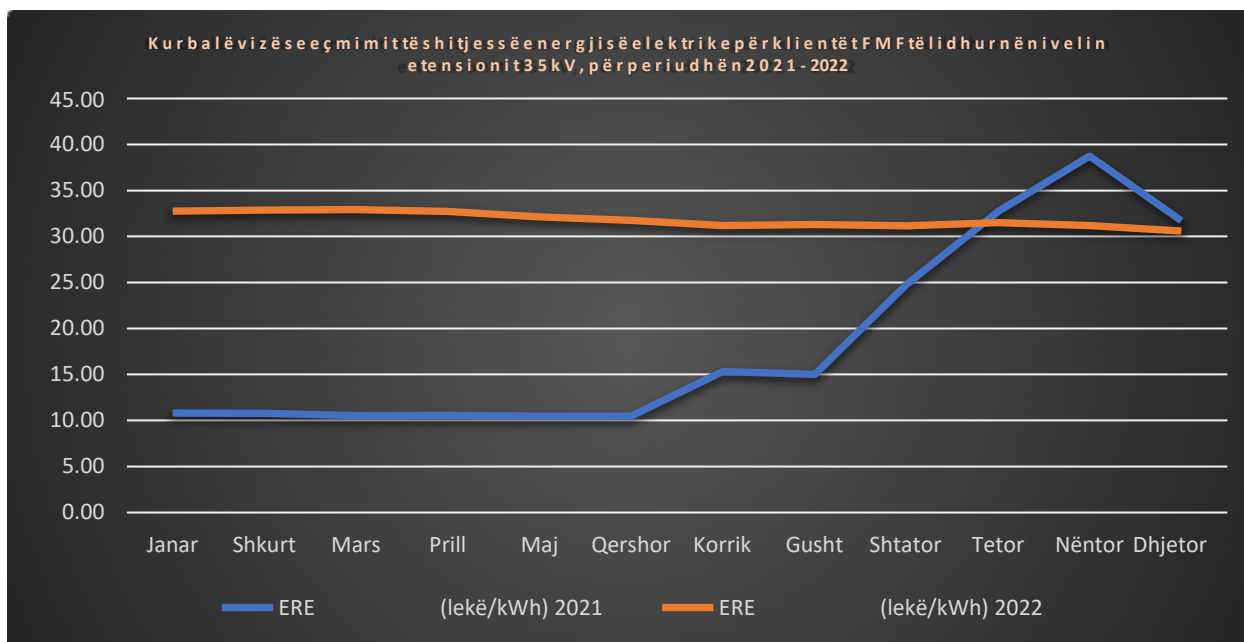

Figure 84 Moving curve of electricity sale prices from the Supplier of Last Resort for customers connected to the 35 kV voltage level, approved by ERE for 2021-2022

(Source ERE)

As it can be noticed in the graphic above, the curve of the electricity sale price approved by ERE Board for 2022 for customers connected at the 35 kV voltage level, who are supplied by the Supplier of Last Resort, is almost horizontal, which means that stability in purchase costs is also reflected in sale prices.

From the analysis of the periodic reports of 2022, it is evident that the amount of electricity sold to the Supplier of Last Resort customers, connected at 35 kV voltage level, was 22.9 GWh, with an invoiced value of 735 million ALL, resulting at an average annual price of ALL 32.11/kWh. In the following table, the differences of these indicators for 2022-2021 are presented.

Periudha (Klientët e lidhur në 35 kV)	Sasia (kWh)	Vlera (Lekë)	Çmimi mesatar i realizuar (Lekë/kWh)
2021	20,938,063	377,010,344	18.01
2022	22,906,846	735,517,781	32.11
Diferencë	9%	95%	78%

Figure 85 Realization of indicators of the Supplier of Last Resort for 2021 - 2022

(Source: OSHEE company, ERE)

For customers connected to the 20/10/6 kV voltage level

With the notification from the Distribution System Operator on the fulfillment of the technical conditions for entering the liberalized market of customers connected to the medium voltage 20/10/6 kV, pursuant to Law 43/2015 "On Power Sector", as amended, starting from January 1, 2022, ERE has published on its website the above announcement and has recalled the right of these customers to freely choose their supplier. Also, it was clarified that in the inability to secure a supply agreement with one of the subjects licensed in this activity, customers have the right to be supplied with electricity by the Supplier of Last Resort.

Pursuant to the decision of the General Assembly of the shareholder, KESH company supplied all the required amount of electricity to the customers of Supplier of Last Resort company, including the customers connected to the 20/10/6 kV voltage levels, who found themselves in the supply conditions of the last resort after 1 January 2022. The cost of purchasing the amount of energy to cover the demand of this category of customers determined in the aforementioned decision was 12 ALL/kWh.

The table below presents the prices approved by ERE Board as well as the respective decisions.

2022	DECISION	Voltage Level	Sale price approved by ERE (ALL/kWh) 2022	Weighted average purchase price of electricity (ALL/kWh) 2022
January	No. 75, Dated 13.04.2022	20 kV	18.80	12.00
		10 kV - 6 kV	19.69	
February	No. 76, Dated 3.04.2022	20 kV	18.80	12.00
		10 kV - 6 kV	19.69	
March	No. 77, Dated 13.04.2022	20 kV	18.80	12.00
		10 kV - 6 kV	19.69	
April	No. 105, Dated 19.05.2022	20 kV	18.80	12.00
		10 kV - 6 kV	19.69	
May	No. 148, Dated 10.06.2022	20 kV - 10 kV - 6 kV	18.26	12.00
June	No. 173, Dated 07.07.2022	20 kV - 10 kV - 6 kV	18.26	12.00

July	No. 207, Dated 17.08.2022	20 kV - 10 kV - 6 kV	18.26	12.00
August	No. 229, Dated 12.09.2022	20 kV - 10 kV - 6 kV	18.26	12.00
September	No. 229, Dated 12.09.2022	20 kV - 10 kV - 6 kV	18.26	12.00
October	No. 229, Dated 12.09.2022	20 kV - 10 kV - 6 kV	18.26	12.00
November	No. 229, Dated 12.09.2022	20 kV - 10 kV - 6 kV	18.26	12.00
December	No. 229, Dated 12.09.2022	20 kV - 10 kV - 6 kV	18.26	12.00
ANNUAL AVERAGE			18.75	12.00

Figure 86 Electricity sale prices for customers connected to 20/10/6 kV voltage levels, supplied by the Supplier of Last Resort for 2022

(Source: ERE, FSHU, KESH)

As evidenced in the table, with the approval of the new electricity distribution service tariffs by ERE Board decision no. 73, dated 13.04.2022, for customers connected to the 20/10/6 kV voltage levels, a single tariff of 3.99 ALL/kWh was determined. The entry into force of this decision from May 1, 2022 was also reflected in the calculations of the sale price of electricity from the Supplier of Last Resort for customers connected to 20/10/6 kV. In the conditions where each component continues to remain unchanged, with decision no. 229, dated 12.09.2022, ERE Board decided to approve the price of 18.26 ALL/kWh, for 01.08.2022 - 31.12.2022 period.

Referring to the energy balance, it results that the amount of energy consumed by customers connected to the 20/10/6 kV voltage levels for 2022 is 1,079 GWh with an invoiced value of approximately 20,058 million ALL.

Period (customers connected at 20/10/6 kV)	Quantity (kWh)	Amount (ALL)	Average realized price (ALL/kWh)
2022	1,079,440,181	20,058,932,674	18.58

Figure 87 Realization of the indicators of Supplier of Last Resort for 2022, for customers connected to 20/10/6 kV voltage levels

(Source: OSHEE company, ERE)

5.1.6 On the approval of the temporary natural gas transmission tariff from Albgaz company for 2023

Implementing Article 17, letter “e”, of Law no.102/2015, “On natural gas sector”, as amended, it is defined that “ERE shall have the right to approve temporary transmission or distribution tariffs when the transmission or distribution operators fail to approve the amendment of the tariffs”

In the absence of the application to review the transmission tariff of Albgaz company, for 2023 period, the submission of the investment plan for 2023 as an important component of calculating the natural gas transmission tariff for 2023 period, as well as implementing the directives of Energy Community, although the access to the network for the users of the Transmission System shall be guaranteed and this company shall provide its services with tariffs regulated by ERE, ERE Board decided to postpone the legal effect of ERE Board Decision no. 206 dated 16.12.2019, for 2023 period, until the approval of a tariff supported on the application of “Albgaz” company where the update and compensation of the required incomes of Albgaz company from the temporary required incomes shall be based on the definitions of Article 17, point “e” of Law no. 102/2015 “On natural gas sector” as amended.

5.2 On defining the electricity purchase price generated from solar, wind and the biodegradable part of solid wastes that utilise the industrial, urban and rural wastes for 2021 and 2022

5.2.1 Defining the electricity purchase price generated from small renewable resources from solar and the biodegradable part of solid wastes that utilise the industrial, urban, rural wastes for 2021

Based on Article 10, point 3 of Law no. 7/2017 “On the promotion of energy usage from renewable resources” and the definitions of Council of Minister Decision no. 369, dated 26.4.2017 “On approving the methodology for defining the electricity purchase price generated from small renewable resources from solar and wind ” and Council of Minsiter Decision no. 27, dated 17.1.2018 “On approving the Methodology for defining the electricity purchase price generated from small generators of renewable resouces from the biodegradable part of solid wastes, that utilize the industrial, urban and rural wastes”, ERE is obliged to define the electricity purchase price generated from small generators of renewable resources from the biodegradable part of solid wastes, that utilize the industrial, urban and rural wastes with installed capacity respectively 2 MW.

Implementing the above legislation as well as MIE orientation where for defining the electricity price generated from small photovoltaic generating sources shall be taken into consideration the methodology of accessing the electricity costs from renewable resources, which shall be based on the same LCOE formula, according to Council of Minister Decision no. 369, dated 26.04.2017.

ERE Board with Decision no. 222, dated 09.11.2021, opened the procedure to define the electricity purchase price generated from small renewable resources from solar, wind and the biodegradable part of solid wastes that ulitize the industrial, urban and rural wastes for 2021 period.

Based on the communications with the Ministry of Infrastructure and Energy, it resulted that for 2021 period it is not issued the final approval for the construction of the acts from small renewable resources from solar or from small generators with renewable resource from the biodegradable part of solid wastes that utilise the industrial, urban and rural wastes.

In the absence of the entities equipped for the final approval and the data on the real investment cost, it was not applicable to define the electricity purchase price generated from photovoltaic plants as well as the biodegradable part of solid wastes that utilize the industrial, urban and rural wastes with installed capacity up to 2 MW for 2021 period.

On these conditions, ERE Board with Decision no. 26, dated 14.02.2022 approved the termination of the procedure on defining the electricity purchase price generated from small renewable resources from solar and the biodegradable part of solid wastes that utilize the industrial, urban and rural wastes for 2021.

5.2.2 Defining the price of electricity produced by the urban waste processing plant in the city of Elbasan for "Albtek Energy" company

Regarding the small renewable resources from solar and the biodegradable part of solid wastes that utilise the industrial, urban, rural wastes during 2022, ERE has addressed the problem arising for the determination of electricity sale price from the urban waste processing plant of Albtek Energy company with an installed capacity of 2850 KW". The Ministry of Infrastructure and Energy (MIE) with official letter Protocol no. 797/2 dated 06.06.2022, requested from ERE the handling of the subject's request for determining the electricity sale price of the urban waste processing plant in Elbasan, from "Albtek Energy" company, referred to the plant operation costs, according to the legal provisions and ERE competencies.

Meanwhile, "Albtek Energy" company was seized by decision no. 484, dated 13.12.2021, of the Special Court of First Instance Against Corruption and Organized Crime, and for its administration an administrator has been appointed by the Agency for Administration of sequestrated and confiscated assets, near the Ministry of Internal Affairs.

With official letter dated 14.06.2022, protocolled at ERE with Protocol no. 165/8, dated 14.06.2022, "Albtek Energy" company has informed that: "Determination of the electricity sale price from the urban waste processing plant in the city of Elbasan, as requested by MIE with official letter Protocol no. 797/2 dated 06.06.2022, would provide a solution to the created problem and, as a result, would bring the end of the judicial process between ERE and Albtek Energy".

Following these communications, ERE assessed that it was necessary to determine the electricity sale price of the urban waste processing plant in Elbasan based on the plant's operating costs.

Pursuant to Council of Ministers Decision no. 907, dated 17.12.2014 "On granting the approval for securing the necessary financing of the concession contract for the construction and administration of the urban waste processing plant of the district of Elbasan and the production of energy" as well as the concession contract in the "BOT" form " (Build—Operate-Transfer) for the construction and administration of the urban waste processing plant of the district of Elbasan, signed between the Ministry of Environment and "Albtek Energy" company, ERE has the obligation to approve the price of electricity produced by the concessionaire for the entire term of the concession agreement, as defined in article 5.2.1, 144 letter"d", point (iii) of this contract.

Under these conditions, ERE Board, with decision no. 159, dated 17.06.2022 decided to approve the electricity sale price of 5.77 ALL/kWh, for the electricity generated by the urban waste processing

plant in the city of Elbasan with an installed capacity of 2850 KW, throughout the entire period of the agreement the concession.

5.2.3 Defining the purchase price of electricity produced by small renewable solar sources with an installed capacity up to 2MW for 2022

Pursuant to the aforementioned legislation, ERE Board with decision no. 27, dated 14.02.2022 approved to open the procedure to define the purchase price of electricity produced from small renewable sources from the sun, wind and from the biodegradable part of solid waste that uses industrial, urban and rural waste for 2022.

After reviewing the documentation submitted at MIE and ERE of the companies that were provided with the final approval for the construction of photovoltaic plants, in accordance with the Methodology approved by Decision No. 369, dated 26.04.2017, and ERE assessments, ERE Board with decision no. 166, dated 28.06.2022 approved the purchase price of electricity produced by photovoltaic plants with an installed capacity of up to 2 MW of 97.21 Euro/MWh, for 2022.

5.2.4 Electricity purchase price from existing priority producers for 2022

Based on the definitions of Law no. 7/2017 “On the promotion of using electricity from renewable resources”, the electricity purchase price from existing priority producers shall be calculated by ERE, in conformity with the “Methodology for approving the annual electricity purchase price that shall be paid to existing priority producers”, approved with Council of Minister’s Decision no. 687, dated 22.11.2017, as amended with Council of Minister Decision no. 396, dated 13.5.2020 “On some amendments on Council of Minister’s Decision no. 687, dated 22.11.2017, “On approving the methodology for defining the annual electricity purchase price, that shall be paid to existing priority producers”.

From the data of the annual Power Exchange Report of Hungary (HUPX) the average annual price for the day ahead market (HUPX/DAM) of electricity in the base load profile for 2021 period resulted **101.40 Euro/MWh**.

From the data published from the Bank of Albania on the power exchange ALL/EUR for each day of 2022, resulted that the average exchange rate for 2021 period shall be **122.61 ALL/EUR**.

Following the collection of the aforementioned data and the implementation of the definitions of Council of Minister Decision no. 687 dated 22.11.2017 of the “Methodology for setting the annual electricity purchase price that shall be paid to existing priority producers”, as amended, the electricity purchase price from the existing priority producers for 2022, resulted **8.5652 ALL/kWh**.

According to the above, Board of ERE, with Decision no. 253, dated 21.12.2021, approved the annual price of **8.5652 ALL/kWh** that shall be paid to existing priority producers for 2022.

5.3 The indicators of production and income from the electricity sale of the priority producers of electricity & Ashta HPP for 2022

Electricity production from priority producers of electricity (HPPs with capacity up to 15 MW) in 2022, had a decrease of 10.16% compared to the electricity production of 2021. Also, the production of Ashta HPP for 2022 has a decrease of 19.97% compared to the 2021 production.

The following graphic shows the progress of the electricity produced in years from the electricity sale for priority producers and Ashta HPP.

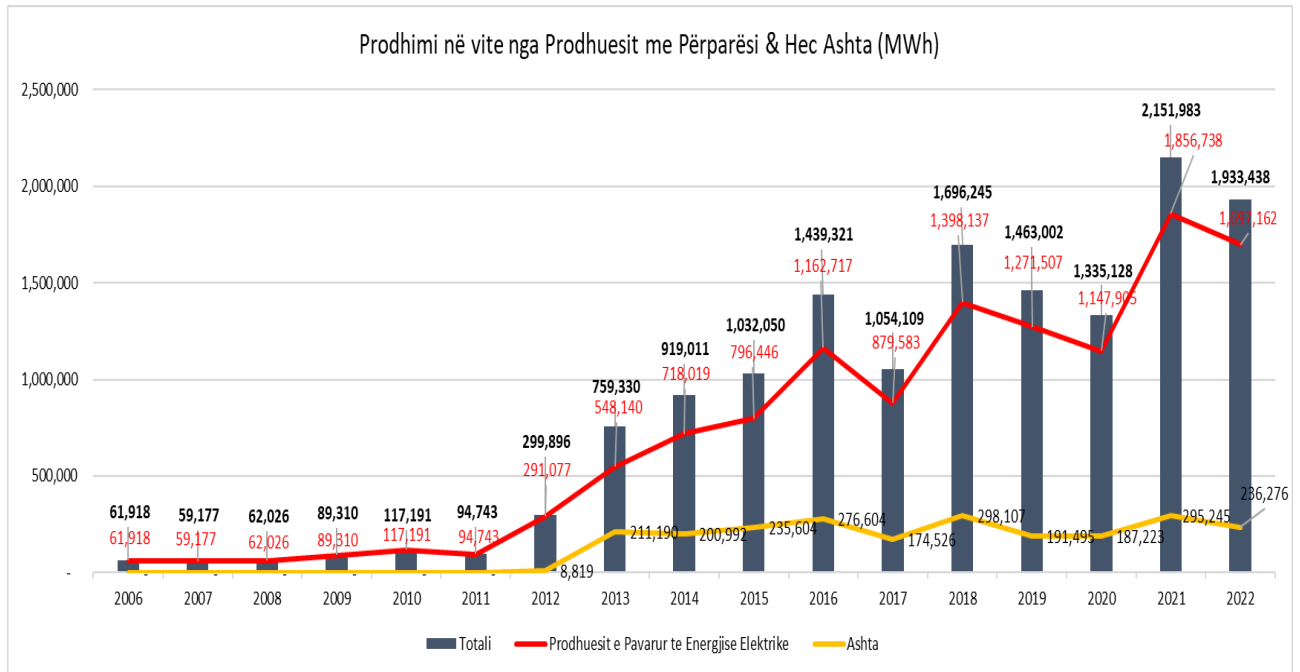

Figure 88 Production progress in years by Priority Producers and ASHTA HPP

The following graphic presents the progress of the income realized from the sale of electricity for priority producers and Ashta HPP over the years.

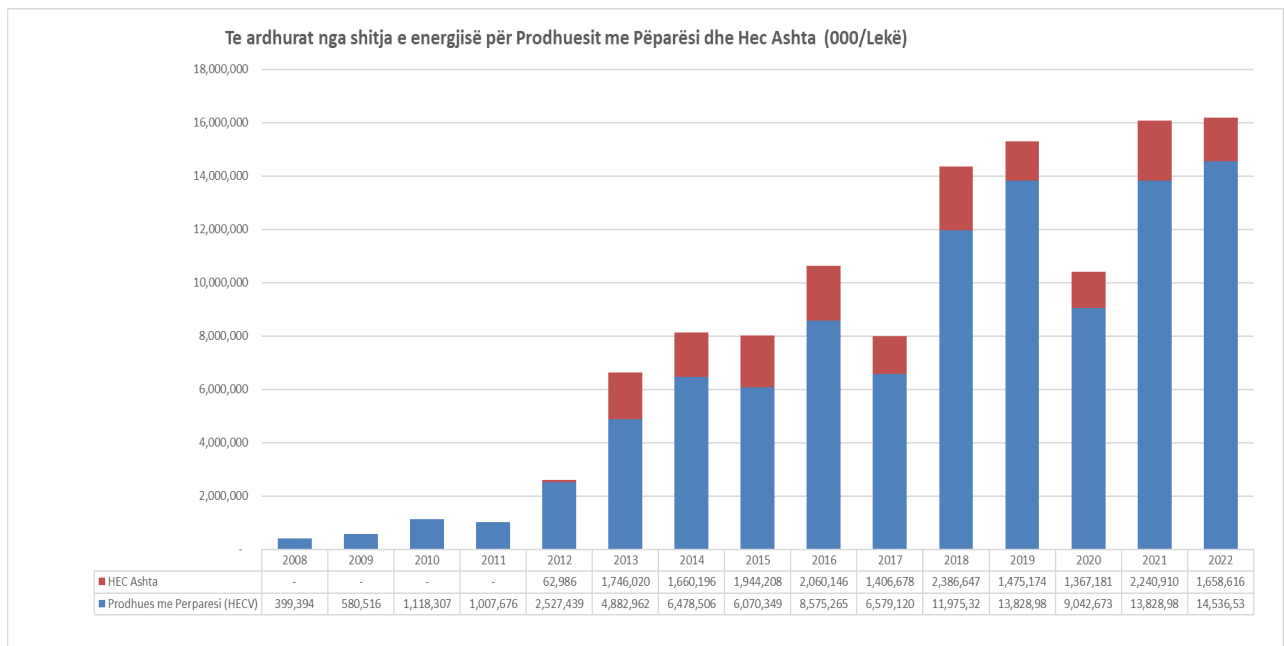

Figure 89 Income from priority producers

(Source: OSHEE company)

As can be noticed from the graphic above for 2022, the level of the realized income by Existing Priority Producers has had an increase of 5.12%, while the income realized by Ashta HPP has had a decrease of 25.98% compared to the previous year. The changes in income have come as a result of the price increase for Existing Priority Producers, while for Ashta HPP it has come as a result of the

drop in the exchange rate of ALL/Euro for 2022.

5.3 Electricity purchase cost implementing the conditions for setting public service obligation from the licensee on the power sector for 2021 period

5.3.1 The electricity purchase cost from the “Universal Service Supplier” company

FSHU company implementing public service obligation, that shall be implemented to the licensee on power sector, which perform electricity production, transmission, distribution and electricity supply activity, shall have the obligation of electricity purchase produced from the electricity production company, whose shares are controlled by the state (KESH company), as well as electricity purchase in the irregulated market, by the public company of supply in the free market (FTL) for the unsecured quantity from the electricity production company according to the value defined on the contract.

With the announcement of the state of emergency in the electricity supply, the Council of Ministers with decision no. 620, dated 22.10.2021, approved the conditions for establishing the public service obligation for licensees in the power sector, during the state of emergency in the electricity supply and for coping with its prevention and reviewed it through decision no. 758, dated 9.12.2021. Subsequently, in this decision, it was foreseen that the Universal Service Supplier, in order to fulfill the requirements of the customers who benefit from the Universal Supply Service, in accordance with the provisions of point 1, article 109, of Law no. 43/2015, "On Power Sector", as amended, imposes the public service obligation to purchase the necessary amount of electricity, produced by the electricity production company, whose shares are fully or partially controlled by the state. The production company, charged with the public service obligation, supplies the Universal Service Supplier with all the necessary quantity, for the purpose of meeting the full demand of the Universal Service Supplier, according to the price per unit of electricity, approved by the General Assembly of the Company. In the following, during 2022, as mentioned above, the Albanian Government through decision no. 456, dated 29.6.2022, decided to approve the conditions for establishing the public service obligation, which shall be applied to licensees in the power sector, who exercise the activity of production, transmission, distribution and supply of electricity, decision which also determined the necessary provisions for coping with the emergency situation in the electricity supply, based on the provisions of Law no. 43/2015, "On Power Sector", as amended.

As mentioned above, the amount of energy purchased for the purpose of the universal service supply during 2022 was provided by KESH company. The electricity purchase price from KESH company according to the decision of the General Assembly of the Company in 2022 was about 2.6 ALL/kWh.

During 2022, the company's financial position has been improving as a result of the procurement of electricity for the purpose of supplying customers who are served by the universal supply, which during 2022, were only customers connected at the 0.4 kV voltage level.

The incomes realized by household customers have resulted in the same levels as those realized during 2021. As for the incomes realized by non-household customers, a marked difference is evident in the decrease due to the fact that already connected customers at 20/10/6 kV voltage level; which are already supplied from January 1, 2022 under the conditions of the last resort, as mentioned above in this report. Consequently, the income realized from the sale of electricity from Universal Service Supplier company during 2022, from the universal service supply there was a decrease of 20.4% compared to the income of 2021, as reflected in the following table.

	Amount (kWh)		Difference in quantity 2022-2021	Difference in % 2022-2021
	2022	2021		
Non - household	1,332,357,733	2,361,544,884	(1,029,187,151)	-43.6%
Household	3,071,883,298	3,081,617,068	(9,733,770)	-0.3%
Total	4,404,241,031	5,443,161,952	(1,038,920,921)	-19.1%
Income (ALL)				
Description	Income (ALL)		Difference in (ALL) 2022-2021	Difference in % 2022-2021
	2022	2021		
Non - household	18,200,287,643	30,247,533,596	(12,047,245,954)	-39.8%
Household	29,182,934,335	29,279,819,610	(96,885,274)	-0.3%
Total	47,383,221,978	59,527,353,206	(12,144,131,228)	-20.4%

Figure 90 The amount of energy sold and the income from the sale of electricity of the Universal Service Supplier

(Source: Universal Service Supplier, OSHEE company)

5.3.2 Electricity purchase cost from "Distribution System Operator" company to cover the losses in the electricity distribution network for 2022

The amount of electricity purchased for the purpose of covering the losses of the electricity distribution network, consists of:

94% of the amount was procured from private HPPs and Ashta HPP

3% of the amount was procured from the free market

3% of the amount was procured from the production of renewable photovoltaic sources

In the following graphic, it is presented the amount of electricity for the purpose of covering the losses of the distribution network, according to the source, for 2022 compared to 2021.

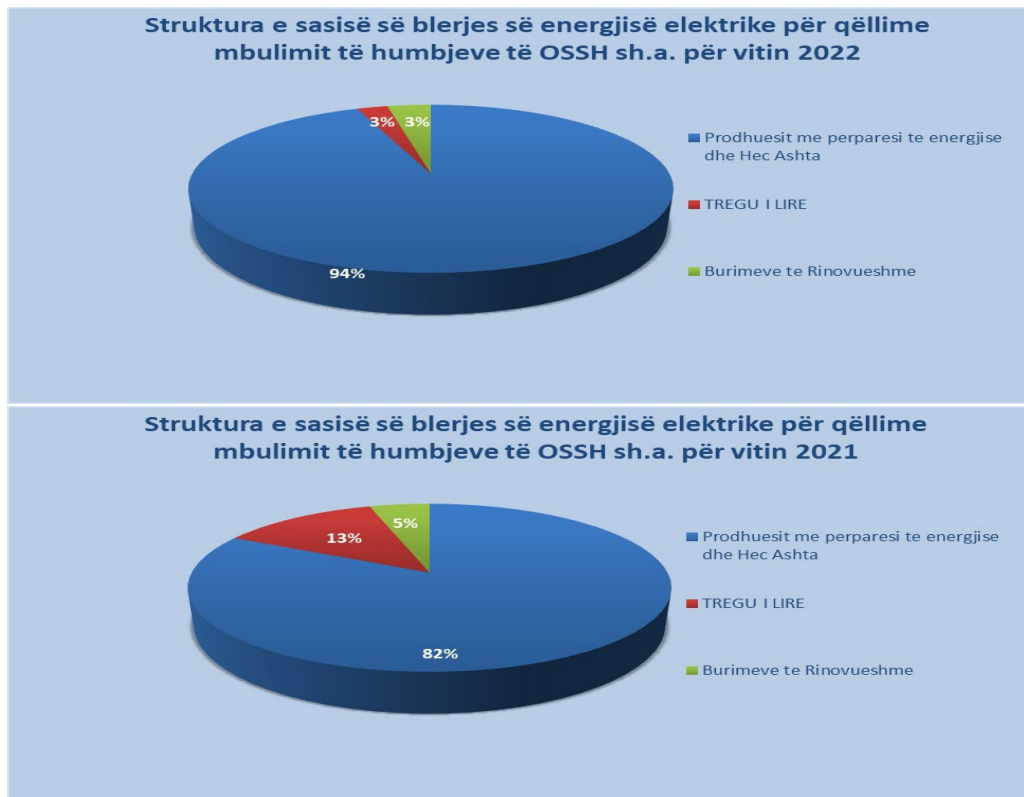

Figure 91 The structure of the amount purchased to cover the losses of the distribution network for 2022-2021

(Source DSO company, OSHEE company)

The structure of the expenses of DSO company for the purchase of electricity to cover losses, for 2022, is presented as follows:

86% of the purchase costs are represented by the energy purchased from private HPPs and Ashta HPP.

10% of purchase costs are represented by energy purchased from the free market

4% of the purchase expenses is represented by the energy purchased from BRE (photovoltaic plants).

In the following graphic, it is presented the structure of electricity purchase expenses from DSO company for 2022 compared to 2021.

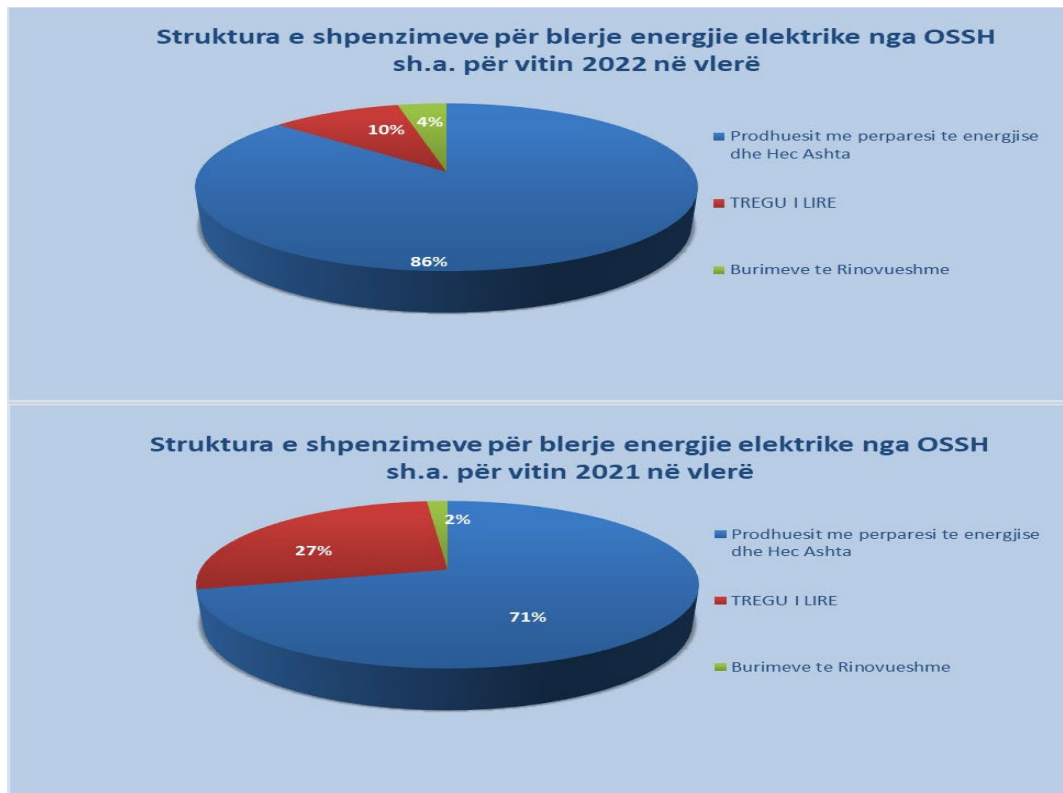

Figure 92 Structure of electricity purchase expenses to cover the losses in the distribution network for 2022 - 2021 (Source DSO company, OSHEE company)

As mentioned above, the Albanian Government through decision no. 456, dated 29.6.2022, decided to approve the conditions for establishing the public service obligation, which shall be applied to licensees in the power sector, who exercise the activity of production, transmission, distribution and supply of electricity. In this decision, it is foreseen that the excess monthly amount of electricity, created by the public production company, after fulfilling the demand of universal customers, in accordance with the provisions of the contract arranged between the parties, according to the provisions established in point 4, of this article, as well as after the exhaustion of the amount of energy produced from renewable energy sources in the preceding periods is sold to the Free Market Public Supplier, for the account of the Distribution System Operator, to cover losses, at the price of energy purchase of producers with water advantage. This provision of the aforementioned decision has enabled DSO company maintaining in a balanced manner the costs of covering the losses of the distribution network without being affected by the high costs of free market procurement which have been at high levels generally throughout 2022.

The Draft, Review and Approval of the Methodologies of calculating the tariffs on Power and Natural gas sectors

Approval of the “Methodology for Calculating the tariff of Natural Gas Storage Service”

ERE Board, with decision No. 107 dated 19.05.2022 decided to open the procedure to approve the Methodology for Calculating the tariff of Natural Gas Storage Service.

After this decision-making, ERE published the draft methodology for consultations and invited the "Ministry of Infrastructure and Energy", the "Competition Authority", the "Commissioner for the right to information and the protection of personal data" to submit their comments and opinions. Albanian Consumer Association", "Consumer Protection Office, consumer association in focus", "Albpetrol" company, "Albgaz" company, "Phoenix Petroleum", "C.G.C", "Balkgaz", " TAP AG ALBANIA", "GSA", as well as electronically notified the "Energy Community Secretariat".

In response to the above request, the Commissioner for the right to information and the protection of personal data stated that the act does not conflict with the legislation under the competence of the Office of the Commissioner for the Right to Information and the Protection of Personal Data."

Also, the Energy Community Secretariat expressed its agreement on the draft methodology.

The Methodology for Calculating the tariff of Natural Gas Storage Service, the purpose of this methodology, is to define the criteria, conditions and the approach for calculating the tariff of Natural Gas Storage service (the injection, storage and withdrawal of natural gas), based on clear calculation of costs principles regarding this service for the determination of fair and transparent prices, in accordance with the regulatory acts approved by ERE, carried out by the Operator of the licensed natural gas storage system. The service tariffs for the operation of the natural gas storage facilities defined in this Methodology shall be applied by the Storage System Operators, who are legal entities, licensed by ERE, and who:

perform the storage activity and are responsible for the Operation of natural gas storage plants according to Article 59 of Law no. 102/2015 “On Natural Gas Sector”;

received the approval to use the existing plants of the system, in conformity with Articles 11 and 59 of Law no. 102/2015 “On Natural Gas Sector”, as amended

implement the general rules for the access and ensuring the facility to the users of the storage plant and that are monitoring object by ERE according to Article 64, letter c) of Law no. 102/2015 “On Natural Gas Sector” as amended;

shall provide to the storage facility users both bundled and unbundled services of storage, injection and withdrawal facilities of natural gas, according to the signed contracts supported on Article 67 of Law no.102/2015 “On Natural Gas Sector” as amended;

ERE Board, with decision no. 107 dated 19.05.2022, decided to approve the " Methodology for Calculating the tariff of Natural Gas Storage Service".

Tariffs and prices approved throughout the years by ERE and the electricity prices in the Region Countries for 2022

Tariffs and prices approved by ERE throughout the years

On the following graph and table it is submitted the progress of the electricity prices and tariffs approved by ERE throughout the years implementing the effective legislation.

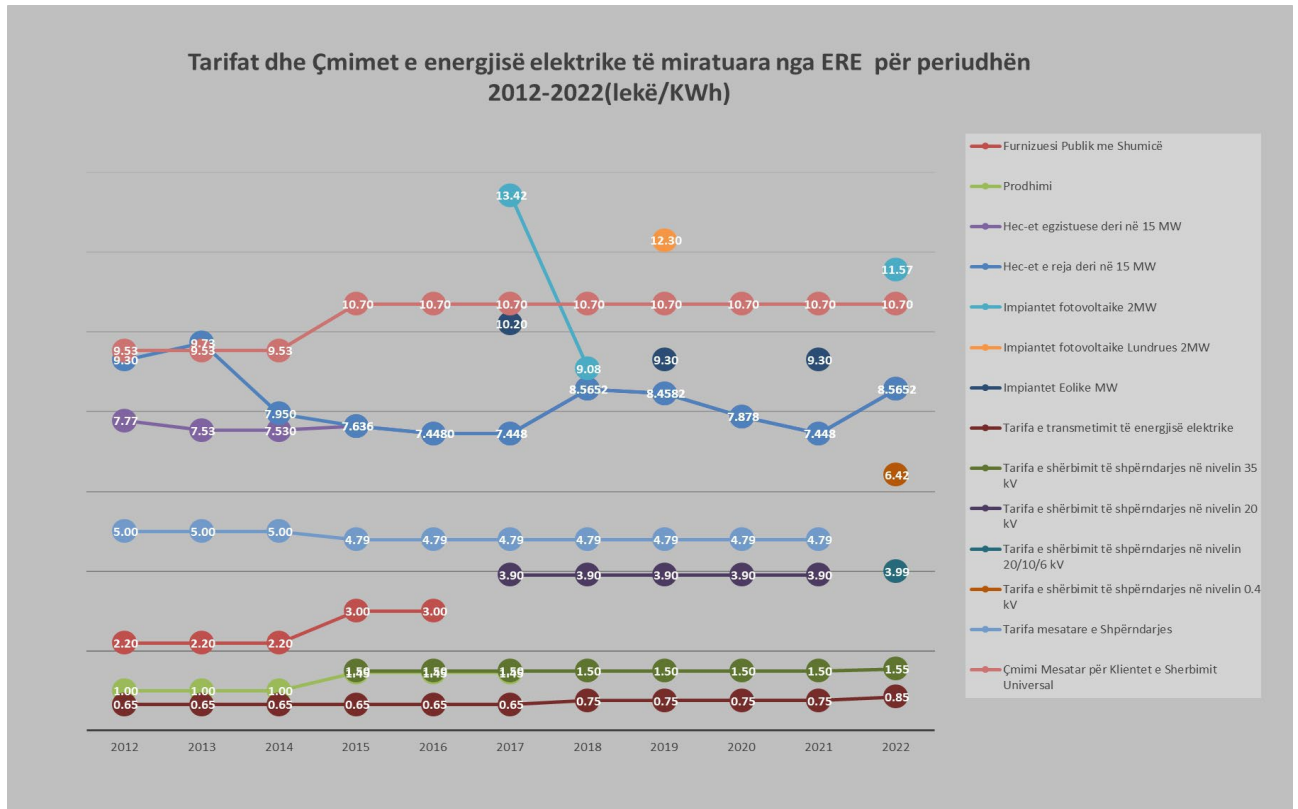

Figure 93 Tariffs and prices of electricity approved by ERE throughout the years for 2012-2022 period

The following graphic presents the progress of the realized average prices of electricity sale from FSHU company for customers supplied under the conditions of universal service.

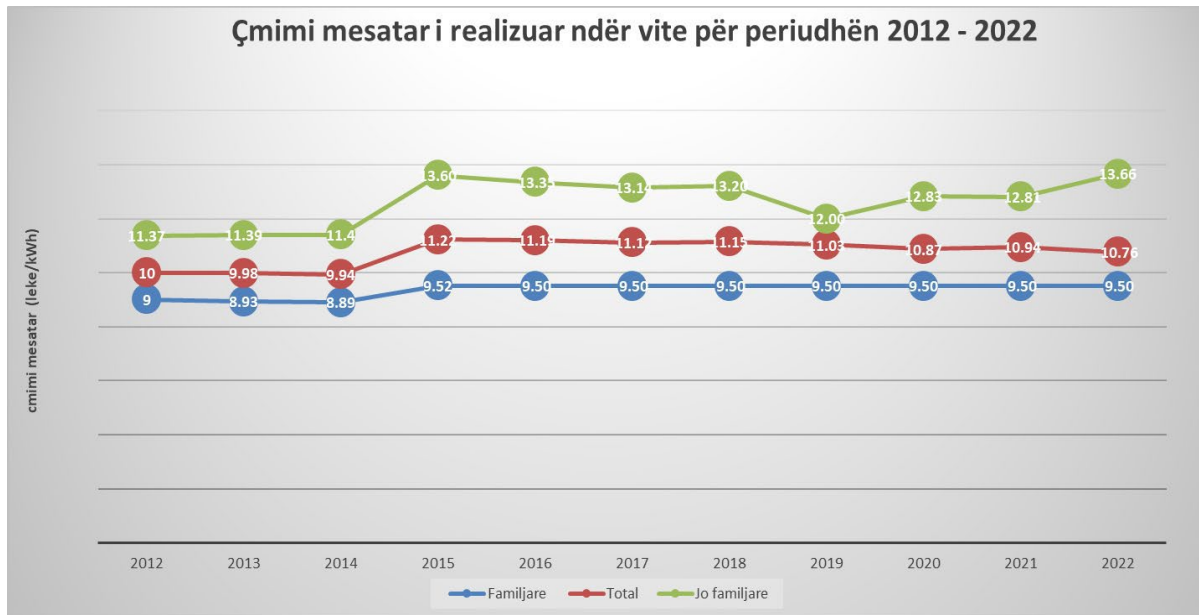

Figure 94 Average electricity sale price from FSHU company, for 2012-2022 period

Based on the sale structure analysis of FSHU company for 2022, the realized average sale price of electricity for end – use customers resulted 10.76 ALL / kWh. The table as follows submits the realized average prices for electricity sale for different categories of end use customers compared to the prices approved by ERE for 2021.

Customer Category	Approved price for 2022		Realized average price for 2022	
	Aktive	Ne pik	Aktive	Ne pik
Customers connected in 0.4kV	14.00	16.10	14.03	16.09
Bakery and flour production at 0.4 kV	7.60	8.74	7.60	8.73
Cult facilities/Religious community	9.50	10.93	7.60	8.73
Household	9.50		9.50	
Shared premises	9.50		9.50	
Average price	10.70		10.76	

Figure 95 Average electricity sale price for different categories of end use customers

5.4 Electricity prices in Region countries for 2022

On the following graphic are submitted the electricity prices in eurocent/kWh and ALL/kWh before VAT for non-household customers for 2022. According to data published by EuroStat, the average electricity price for non-household customers in the region countries for 2022 period resulted 13.18 ALL /kWh.

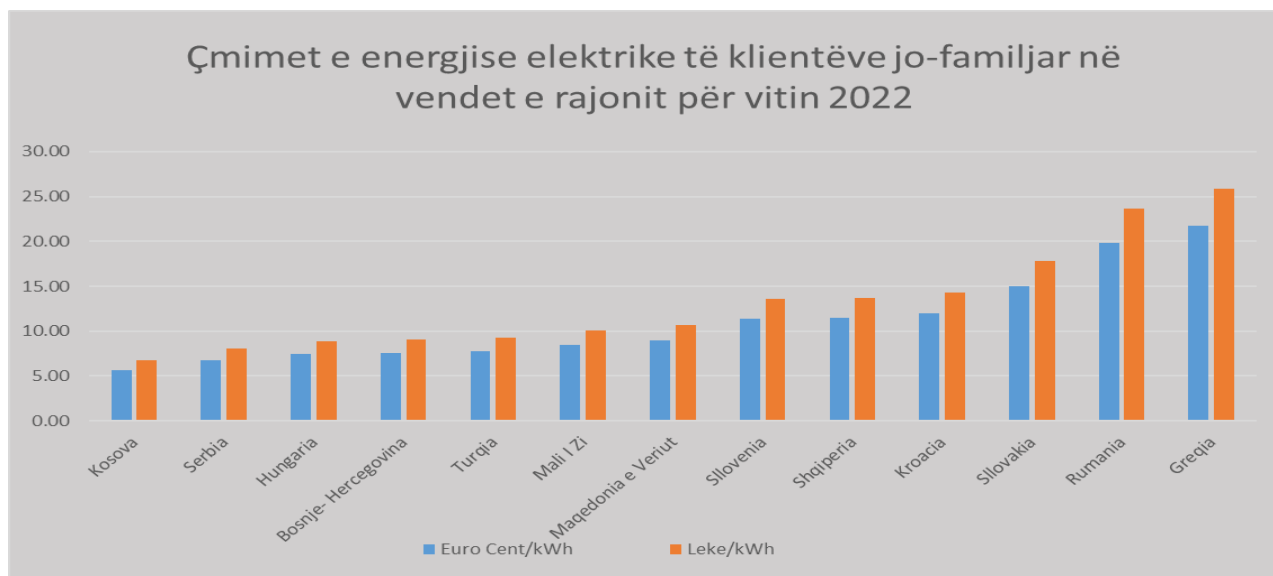

Figure 96 Electricity prices for non-household customers of electricity in region countries for 2021

(Source Eurostat)

In the following graphic are submitted the electricity prices in eurocent / kWh and ALL / kWh before tax (VAT) for household customers for 2022. The average price of electricity for household customers for the regional countries for 2021 resulted in 17.45 ALL/kWh

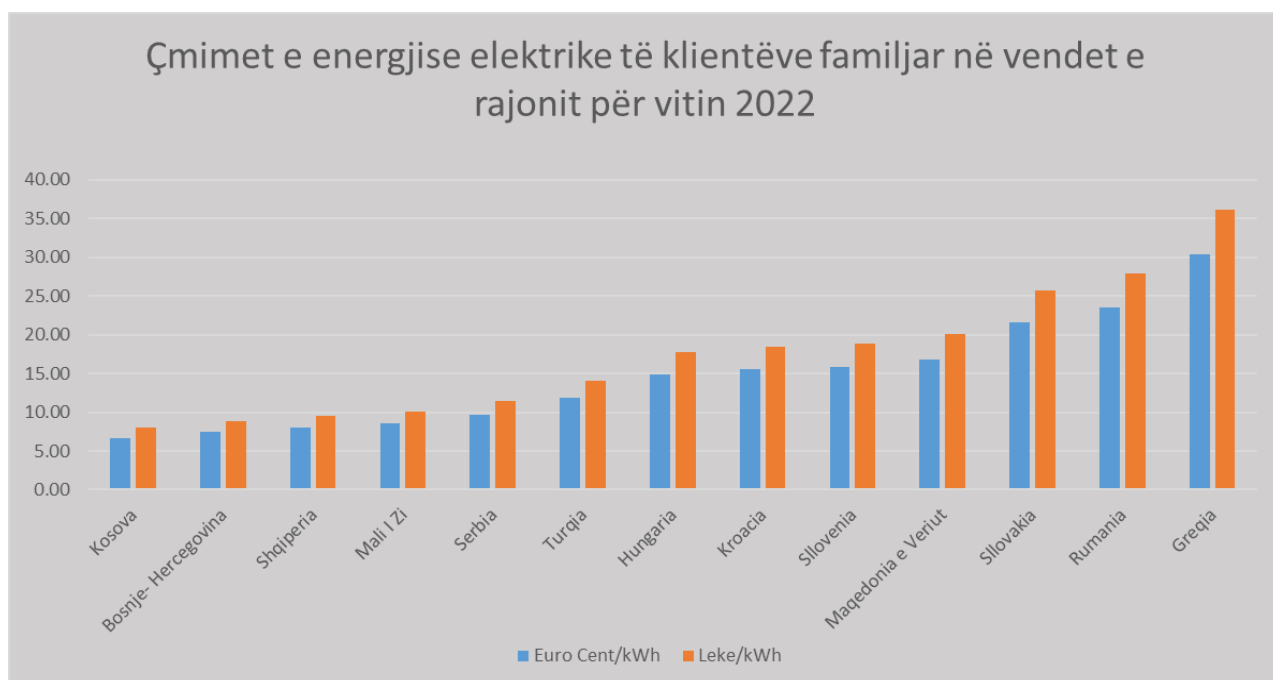

Figure 97 The electricity prices for household customers in region countries for 2022

1. REGULATION OF NATURAL GAS SECTOR

European and global natural gas markets are not yet out of danger created by a reduction in supply from Russia. Conditions have been and remain unstable, prices have been extremely volatile. Overall gas demand in the European Union (EU) is down by around 10% in 2022, a drop of around 50 billion cubic meters (bcm). About 10 bcm of this decrease is due to the limited production and not the increase in efficiency or the change of the type of fuel (Oil or Gas), the other part as the policy of the EU to reduce consumption and increase the efficiency of natural gas usage.

As of early December 2021, gas storage levels in Europe remain above their five-year average.

The European Union as a whole is set to add around 40 bcm of LNG import capacity by the end of 2023.

According to experts, mild weather in Europe in the fall and winter of 2022 has reduced gas demand by more than 10 bcm.

The graphic below (according to the International Energy Agency IEA) presents the world's largest natural gas producers, on which the world's gas market also depends. These countries have influenced and continue to influence the reduction of the energy crisis and are mainly the USA, Australia, Qatar, etc.

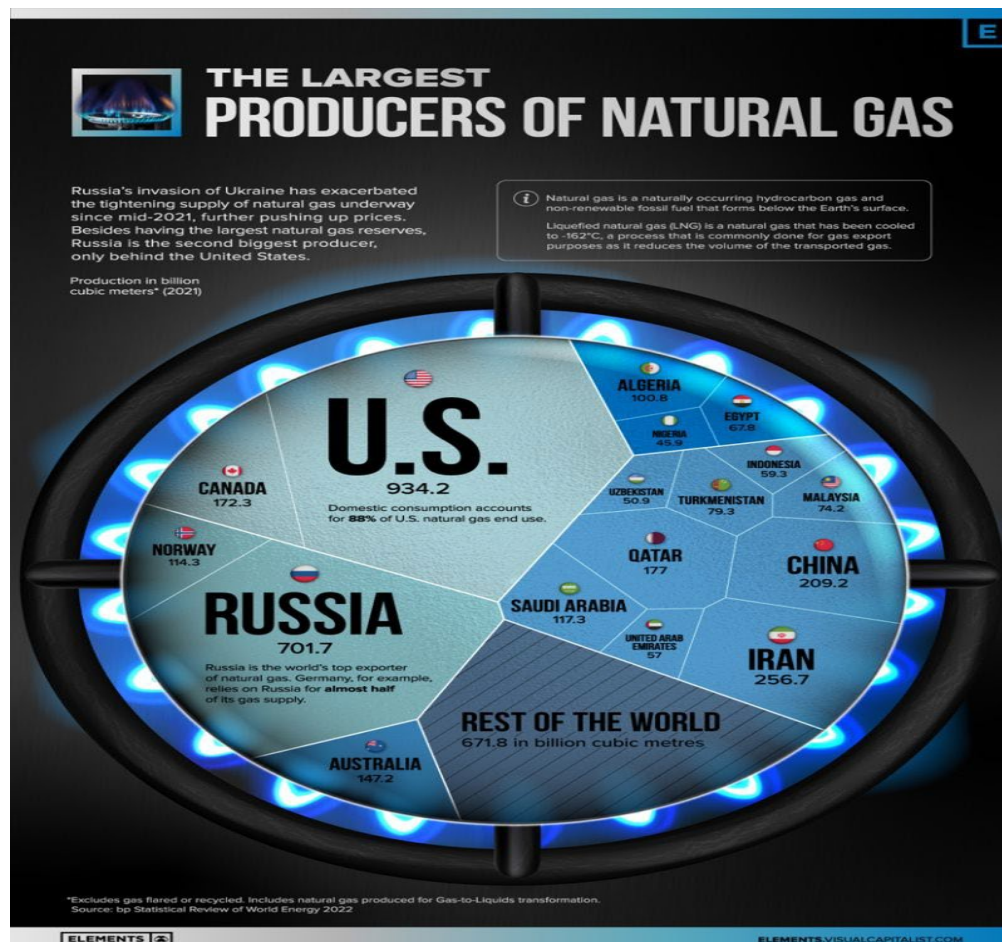

Figure 98 The world's largest producers of natural gas

A number of measures have been adopted by the European Union and by individual European

countries to increase the security of supply. These shall help in new improvements in energy efficiency, installations of renewable resource capacities, etc.

In these conditions it is imperative to encourage the rapid deployment of renewable resources, as shown in the graphic below (according to the International Energy Agency IEA).

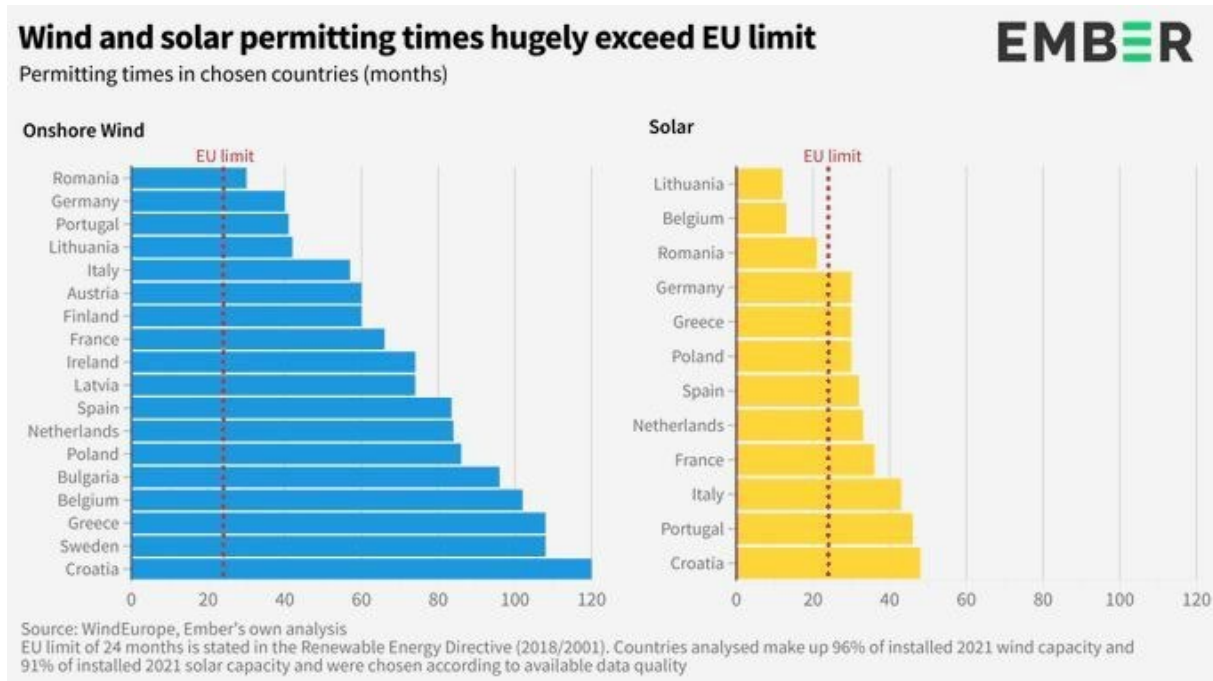

Figure 99 Graphic of deployment of renewable sources from Wind and Sun in Europe

In the graphic below we shall look at the producers of electricity from coal (according to the IEA).

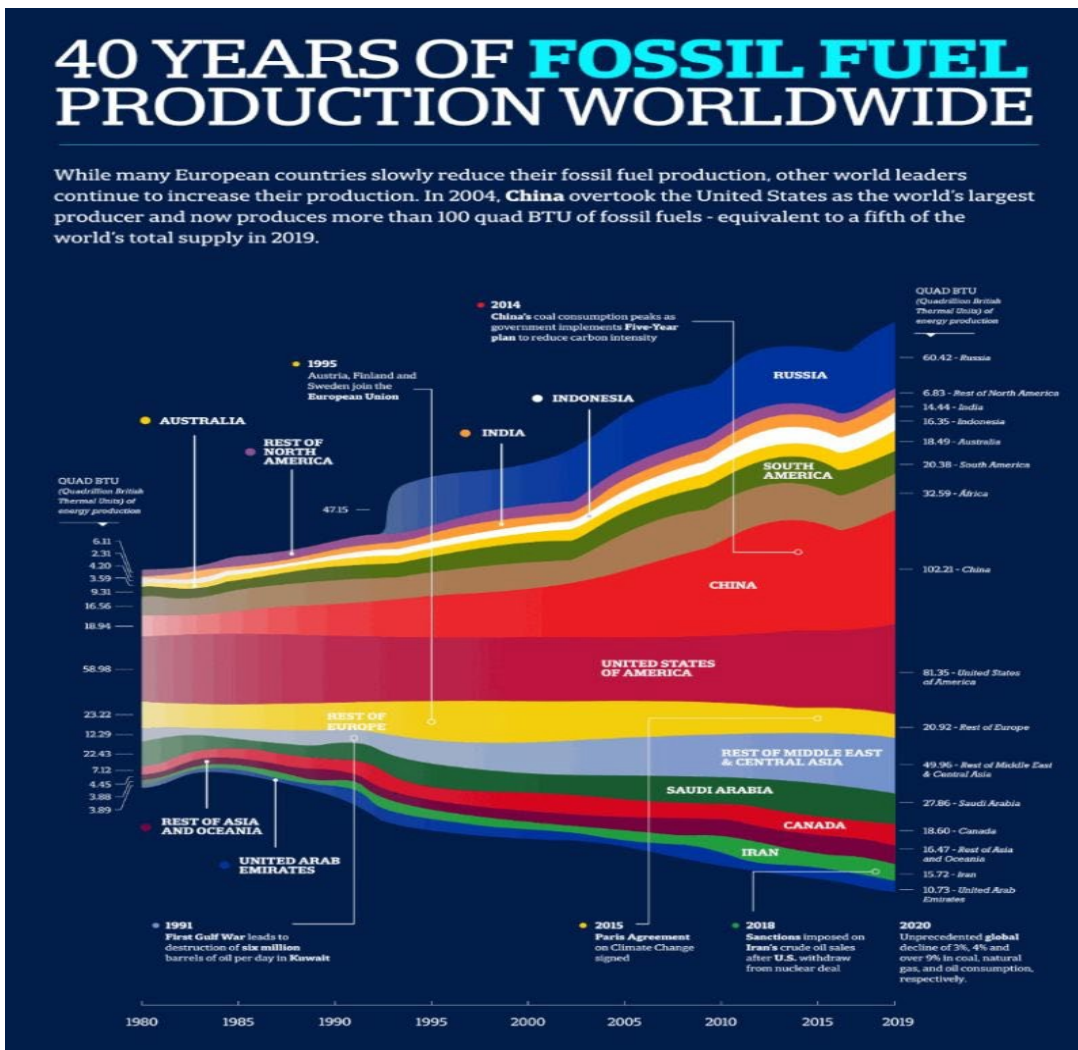

Figure 100 Production of fossil resources in the world

Risks to Europe's gas balance in 2023

The combination of lower demand, a strong increase in non-Russian gas supplies and unseasonably mild weather conditions during October and early November and beyond have allowed the European Union to increase its gas storage levels by a record amount so far for 2022. Injections into EU gas storage facilities were over 70 bcm between April and mid-November, enabling them to reach 95% fill levels by mid-November. As of December 9, 2022, they are about 15% (or 11 bcm) above their five-year average.

High storage levels and lower demand put downward pressure on natural gas prices in October and November and reduced the risk of physical gas supply shortages for the 2022-2023 heating season. However, the buffer provided by relatively high storage levels should not lead to overly optimistic forecasts for the future, as market fundamentals may tighten again in 2023.

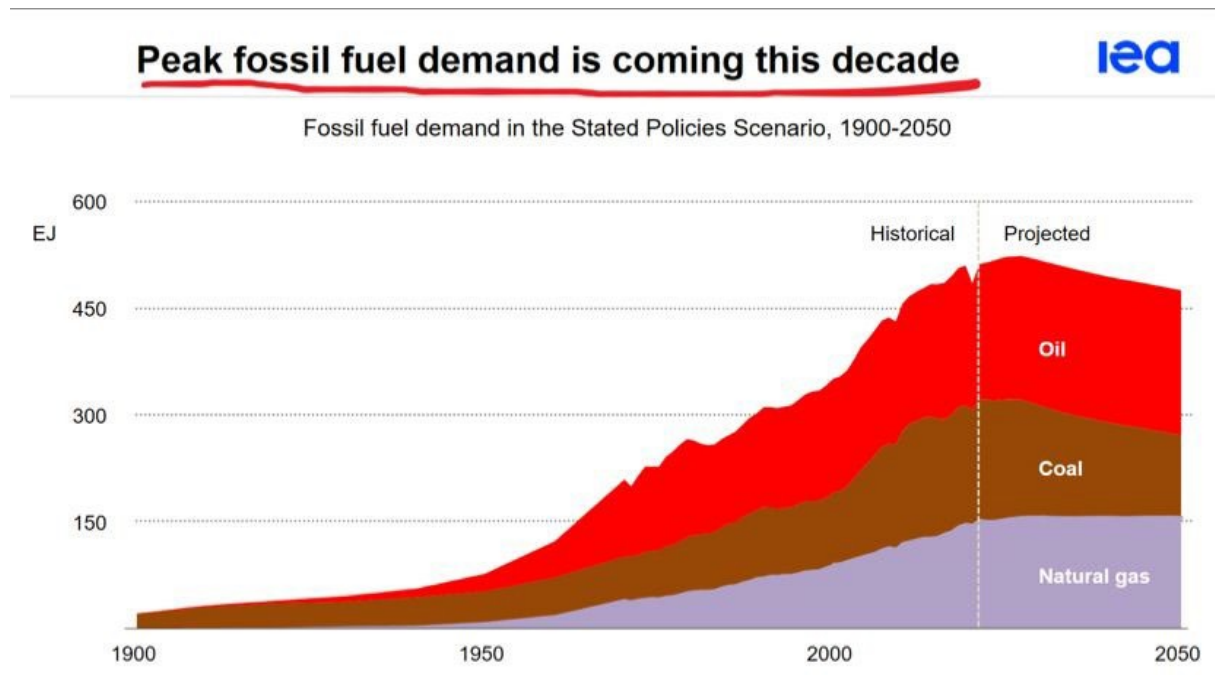

Figure 101 The turning point for fossil energy

In the IEA chart above, this shows that it is one of (many) historical findings according to experts. After decades of transition, the global energy system appears concretely to have reached a turning point.

As mentioned several times by the IEA, there is a powerful combination of key factors pushing for a new era of energy which are; security, climate, economic.

In the chart below, it is presented the world's outlook for energy performance.

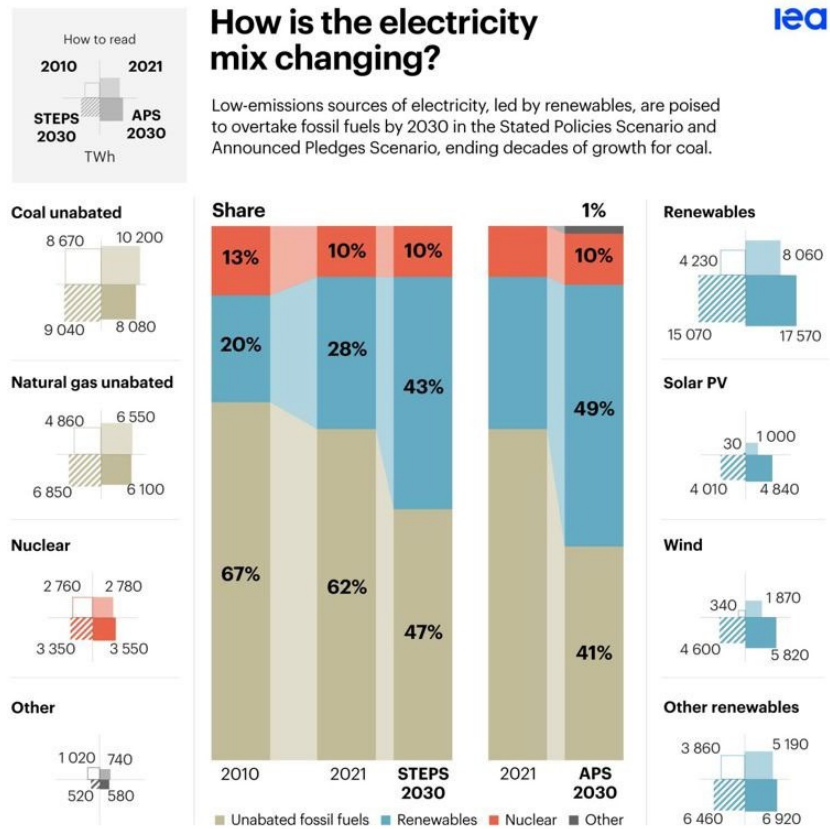

Figure 102 World outlook for mixed energy demand for 2030

The growth of renewable energy production is fast enough to reduce the contribution of fossil fuels for energy according to the new IEA World Energy Outlook.

Gas production in the European Union

Natural gas production in the European Union fell by about 9% (or 3.6 bcm) in the first nine months of 2022.

6.1 Situation in Our Country

In the long-term plan, although new routes avoiding Russia are being developed, the export capacities of the Caspian coastal countries are insufficient to transform into powerful actors for guaranteeing energy to the EU. Therefore, one thing is clear:

The Southern Gas Corridor can bring competition to all EU countries and reduce the role of Russia in the natural gas market.

Regarding the gas situation:

TAP expansion can be done, and is on the way, by adding compressor units to already existing compressor stations and building new compressor stations, after successful Market Tests, which TAP should organize at least every two years, in accordance with its regulatory framework.

TAP has organized its first Market Test in July 2019 and launched another Market Test in July 2021. The 2021 and 2022 Market Test is still ongoing and is now in the binding phase. In the January 16-22, 2023 period, TAP opens the binding bidding phase, where interested parties can submit binding bids to expand capacity at existing and potential TAP interconnection points: Kipoi, Melendugno, Nea Mesimvria, Relievi Roskovec, Kucove and Fier.

In our country, according to TAP's regulatory framework, TAP is cooperating with the Albanian Government and "Albgaz" company for the development of an entry/exit point in Fier locations. In this regard, on July 6, 2021, TAP AG, the Albanian Ministry of Infrastructure and Energy and Albgaz company signed a Cooperation and Handover Agreement on the Fier South Facility. According to the agreement, as soon as the construction of the Fier South facility is completed, it shall be transferred to the Albanian state. The works are in progress.

In the light of recent developments and announced priorities of the Government of Albania, during 2022, represented by the Ministry of Infrastructure and Energy (hereinafter referred to as "MIE") regarding the creation of a terminal for the distribution of liquefied natural gas (in hereinafter referred to as "LNG") as well as the construction of a natural gas pipeline from the Vlora Terminal to Fier, there has been an increased interest from foreign companies (it is worth emphasizing with many years of consolidated experience in the natural gas market) who seek to cooperate with "Albgaz" company for various projects in this sector.

6.2 Trans Adriatic Pipeline (TAP)-Greece, Albania, Italy

6.3 The shareholders of the company

During 2022, there were not any changes of shareholders, all interested parties have been informed about this, including the three National Authorities, the Greek, Italian and Albanian.

TAP AG shareholding is comprised of: SOCAR (Azerbaijan) with 20%, BP (England) with 20%, SNAM S.p.A (Italy) with 20%, Fluxys (Belgium) with 19%, Enagas (Spain) with 16% and Axpo (Switzerland) with 5%.

6.4 TAP a strategic project for Albania and South-Eastern Europe

TAP is the European part and the main part of the Southern Gas Corridor, a strategically and economically important project for the EU and the Energy Community.

TAP is necessary to ensure reliable access to a new source of natural gas from the Caspian Sea and in a new route. TAP strengthens the diversification of sources and supply routes and enables the gasification of Southeast Europe and the Western Balkans, including the gasification of our country. TAP is actively present in the creation and operation of the Albanian gas market.

Among other things, TAP supports the EU's goals to become climate neutral by 2050 and promotes the achievement of the decarbonization goals of the EU and the Energy Community in particular TAP allows the further use of gas (natural, renewable, or decarbonized) replacing more polluting fuels such as coal, diesel/gasoline and heavy oils in the transport, heating and power generation sectors, used more in South-Eastern Europe and the Western Balkans.

TAP pipeline is designed to double its capacity up to 20 billion cubic meters per year (up to 20 bcm / year) and to allow any interested party to submit a request regarding the TAP pipeline, as long as it complies with the technical and regulatory conditions from the Final Joint Opinion.

TAP pipeline has entered the Market Test period for increasing the capacity to 20 billion NM³/year(bcm/year) and now is the public consultation phase.

Following the 2021 market testing, during the non-binding expression of interest phase for 2022, TAP has received significant interest in capacity and connection requirements in Albania.

TAP shall facilitate greater interconnection between countries in the Southeast European region and the creation of a regional gas market fully integrated with the European Market. Through this project, our country is given the opportunity to create an indispensable node for the region because it gives the possibility of underground gas storage as well as an LNG liquefied gas terminal.

6.3 Contribution of TAP actively to European market integration and security of supply

TAP, as the European part and a key part of the Southern Gas Corridor, is an important strategic and economic project for the EU and the Energy Community.

TAP entered commercial activity on November 15, 2020. This was a historic achievement as a new source of gas supply and a sustainable, reliable and cost-effective route was put into operation and began to materially contribute to the security of supply of the EU and the Energy Community, market integration, competition and decarbonisation objectives.

In 2022, in view of the geopolitical situation and TAP's great contribution to alleviating the existing pressure on energy markets, TAP has been recognized by the EU as a solution for energy independence in the REPowerEU plan. On 18 May, the Commission released the RePowerEU plan that recognizes the need to accelerate the energy transition, but acknowledges the important role of gas in achieving the ambitious targets of this plan.

Regarding TAP and the Southern Gas Corridor (SGC), the RePowerEU plan underlines: "The EU shall intensify cooperation with Azerbaijan within the strategic importance of the Southern Gas Corridor. Increasing the capacity of the Trans Adriatic Pipeline (TAP) would increase the supply of gas to the EU and the countries of the Western Balkans. For this purpose, on July 18, the EU signed a Memorandum of Understanding for a Strategic Partnership in the field of Energy with Azerbaijan. This includes a commitment to double the capacity of the Southern Gas Corridor to deliver at least 20 billion cubic meters to the EU per year by 2027.

6.4 TAP – Brief summary of notable developments for 2022

From the date of TAP's commercial operations (November 15, 2020) to date, TAP has transported approximately a total of 19 bcm from the Greek-Turkish border to Kipoi without capacity cuts, with 16 bcm transported all the way to Italy passing through Albania and approximately 2.30 bcm exiting Greece and 0.50 bcm going to Bulgaria, via the IGB pipeline.

From COD (15/11/20) until 16 january 2023	Total KWh	Total bcm	Total BCMA
Entry TAP (Kipoi)	222,404,197,419	18,949,694,799	18.95
Exit TAP (Nea Mesimvria - Greece)	26,893,670,396	2,293,719,204	2.29
Exit TAP (Komotini – IGB)	5,548,357,203	474,232,555	0.47
Entry TAP (Melendugno - Italy) transiting Albania	187,788,869,965	16,020,894,632	16.02

During 2022, TAP became a fully interconnected TSO: the Komotini TAP Interconnection Point connecting TAP with the Greece-Bulgaria Interconnector (IGB pipeline) became operational on

October 1, 2022. Since that moment, TAP has started transporting of gas to Bulgaria, Romania and beyond through the IGB pipeline.

The start of operation of Komotini Interconnection Point, together with the challenging environment of energy markets in 2022, has generated great interest from the market for TAP; Thus, at the end of December 2022, TAP had 25 registered parties and another 12 in the registration process. For information, the list of TAP users can be found and regularly updated on the TAP website. During 2022, in view of the changes in the TAP Network Code, as well as the start of commercial operations of Komotini Interconnection Point, the portfolio of TAP services has been expanded, to respond to the demands and needs of the changing environments of market and shippers. By offering a very large range of products, TAP is contributing to market integration.

Specifically, as of April 14, 2022, TAP began offering a product with Virtual Input Capacity in Nea Mesimvria IP. This added a new (virtual) entry point to the TAP pipeline to provide a forward flow from Nea Mesimvria to Melendugno and improve market integration. In addition, from October 1, at Komotini Interconnection Point, TAP offers the following products on the PRISMA platform with capacity:

Forward firm capacity:

Commercial Reverse Capacity (Route 2: Melendugno – Komotini and Line 3: Nea Mesimvria – Komotini).

Virtual Entry to Komotina (for forward flow to Nea Mesimvria or Melendugno).

To make accessible the products that are available on the market, TAP is conducting capacity auctions in accordance with the ENTSOG Auction Calendar on the PRISMA Capacity Booking Platform. Between the date of TAP's commercial operations and 16/01/23, TAP conducted the following auctions at Kipoi Interconnection Point, Melendugno Interconnection Point and Nea Mesimvria Interconnection Point and Komotini Interconnection Point:

4,114 day-ahead auctions; 127 monthly auctions; 103 quarterly auctions; 2 year auction (commercial reverse capacity only).

During 2022, TAP has provided non-stop transport services; Shippers' bids for the TAP pipeline have been processed immediately and gas deliveries have been successfully brought to the Interconnection Points with the national transmission system in Italy and Greece (SRG and DESFA networks) and the IGB pipeline, starting on October 1, 2022.

TAP has also maintained very close communication with its shippers, connecting TSOs and national regulatory authorities in Albania, Greece and Italy.

In accordance with EU Regulation 715/2009, the Transparency Annex and the non-binding documents issued by the European Network of Transmission System Operators for Gas (ENTSOG), the Annual Maintenance Plan must be published for the next gas year before the November 15 every year. Therefore, on November 15, 2022, TAP published the annual maintenance plan for 2022-2023.

TAP has drafted and approved a special Maintenance Plan for Albania and based on it, it has carried out several maintenance activities within the reporting period according to the "Maintenance Activities Albania 2022" list.

In accordance with the REMIT Regulation, in 2022 TAP has published on the TAP website and on the ENTSOG Transparency Platform 8 (eight) Urgent Market Messages (UMM) that inform the market about the availability of capacities in the TAP pipeline, the offer of new products, the gas tender for commercial operations.

TAP has continuously uploaded operational information on TP ENTSO, such as available, reserved and technical capacities, scheduled firm outages and scheduled outages of interrupted capacity, as well as tariff information. TAP has also published its annual maintenance plan in accordance with the deadline set by Regulation 715/2009 until November 15, 2022.

On December 28, 2020, ERE published decision no. 265, on approving the rules on monitoring the gas market. According to the provisions of the ERE decision, the Gas Monitoring Regulation entered into force on July 1, 2021. TAP has submitted at ERE an overview that explains TAP's fulfillment of reporting and transparency obligations from the Regulation mentioned above in ERE in October 2021. In March 2022, ERE accepted with official letter protocol number 356, the method of reporting information and confirms the fulfillment of the obligations arising from the implementation of the Rules on the Monitoring of the Natural Gas Market in Albania.

Last but not least, it must be mentioned that TAP is fully compliant with all EU and national regulations and is transparent to the market. From the COD onwards TAP has published information on its operational activity and tariffs on transparency platforms defined by the EU on TAP's website and on its electronic data platform, as required by EU regulation- and the Albanian Natural Gas Law 102/2015. TAP is in the top 3 EU TSOs that publish data correctly, completely and on time.

During the calendar year 2022, pursuant to the provisions of Decision No. 15 of ERE from January 31, 2019, TAP:

It has submitted its financial statements (Statement of Financial Position; Statement of Profit or Loss and Other Comprehensive Income; Statement of Cash Flows - Explanatory Notes) for 2021 at ERE.

ERE was also granted insurance certificates in the amount of USD 10,000,000 - for General Liability to Third Parties, valid from November 15, 2022 to April 2024 and with no. Austria Sha and Additional Insured: Energy Regulatory Authority. The certificate is issued in Albanian and English. This obligation to provide the insurance certificate is a recurring obligation that TAP must fulfill throughout the validity period of the Transmission License. This obligation was introduced in the Transmission License through the amendment of the Transmission License in Decision no. 120 of ERE Board, dated 11.05.2021. ERE has been provided with information on the process of asset registration for the Trans Adriatic Pipeline, according to paragraph 2 of ERE Decision on the Transmission License, which stipulates that "no later than 12 months from the start of operation of the gas pipeline, the company shall provide ERE with complete documentation showing the ownership titles on the assets it owns for the purposes of performing its functions or fulfilling its obligations under the license required in the territory of Albania." TAP has provided ERE with the electronic form of the documentation and is currently working on finding a solution to provide them in material form, as requested by ERE, Prot. No. 1073/4, dated December 16, 2021. In decision no. 152 of ERE Board, dated June 13, 2022, ERE amended the above paragraph: "No later than July 1, 2024, the company shall provide ERE with complete documentation on the display of title deeds on the assets it owns for the purposes of performing functions or fulfilling obligations according to the license required in the territory of Albania, in accordance with the provisions of law no. 107/2021 "On co-governance". Decision no. 152 goes beyond to explain that since the ownership documentation - as pointed out by the company - is voluminous, it can be filed in electronic format (on CD) within 24 months, provided it is stamped or issued electronically in accordance with the circumstances for the provisions of law no. 107/2021.

In addition, according to TAP's broader regulatory framework:

- After closing the public consultation on the proposed revision of TAP Network Code, TAP received approval for the requested revision from the Albanian, Italian and Greek NRAs and published a new version of the TAP Network Code in April 2022. In view of TAP's obligations stemming from the TAP Network

Code itself, TAP has continued with the organization of a new public consultation, which opened on December 20, 2022, referring to congestion management procedures and timelines for tenders for the purchase of gas for commercial operations.

➤ TAP opened a new public consultation on TAP network code on 20 December 2022. The current review aims to implement obligations for TAP regarding short-term congestion management procedures, as well as guide tendering requests.

6.5 TAP capacity expansion

TAP expansion can be realized by adding compressor units to already existing compressor stations and building new compressor stations, after successful Market Tests, which TAP must organize at least every two years, in accordance with its regulatory framework.

TAP has organized its first Market Test in July 2019 and launched another Market Test in July 2021. The 2021 Market Test is still ongoing and is now in the binding phase. In 16-22 January 2023 period, TAP opens the binding bidding procedure, where interested parties can submit binding bids to expand capacity at existing and potential TAP interconnection points: Kipoi, Melendugno, Nea Mesimvria, Relievi Roskovec, Kucove and Fier.

Specifically, the Incremental Capacity Project consists of the following:

Incremental Capacity offered by TAP and SRG at the Melendugno Interconnection Point as a connecting product for capacity, with exit from TAP and entry from SRG.

Incremental Capacity offered by TAP and DESFA at the Interconnection Point of Nea Mesimvria as a connecting product for capacity, with exit from DESFA and entry from TAP.

Incremental Capacity offered by TAP and DESFA at the Interconnection Point of Nea Mesimvria as a connecting product for capacity, with exit from TAP and entry from DESFA.²

Incremental Capacity offered by TAP at the Interconnection Point of Kipoi, as unbundled entry capacity.

Incremental capacity offered by TAP at the Interconnection Point of Komotini as unbundled exit capacity.

The capacity provided reflects the available capacity of the TAP exit point at the Komotini Interconnection Point without factoring in any expansion capacity on the Greece-Bulgaria Interconnector (IGB). Therefore, the Participants shall be solely responsible for ensuring that the relevant expansion capacity is available on the other side of the Komotini Interconnection Point with the Greece-Bulgaria Interconnector and TAP offers no guarantee and has no liability to the Participants regarding this situation. Participants should also note that the Greece-Bulgaria Interconnector itself shall not participate as a neighboring TSO in the market test.

Offers for incremental capacity from TAP at the possible exit point in Kuçovë as unbundled capacity.¹

The offer for incremental capacity from TAP, at the possible exit point in Fier as an interruptible exit capacity.²

¹ The products of this capacity in Nea Mesimvria are based on a relevant TSO initiative and do not attempt to cover non-binding demand indications presented during the non-binding phase.

² It is the Participant's responsibility to initiate any procedures that may be necessary to make capacity available downstream of the TAP. TAP makes no representation as to the availability of such capacity or the existence of required facilities outside of TAP.

The offer for incremental capacity from TAP, at the possible entry point in Fier as unbundled entry capacity³

Incremental capacity offered by TAP as unbundled exit capacity at the prospective Exit point of Relievi Roskovec.

Incremental capacity offered by TAP as unbundled exit capacity at the possible exit point of Relievit Roskovec.⁴



Figure 103 TAP project capacity expansion

After receiving the binding offers, TAP shall continue with capacity distribution and signing long-term gas transport agreements with the parties whose offer has passed TAP's economic viability test.

Depending on the level of expansion for which bids are received by January 22, 2023, expansion capacity may be available as follows:

1. Level 1: TAP minimum expansion – to an actually built total capacity entry Kipoi of 39.8 MSm³ per day (387 GWh/day) (Minimum Expansion Project)
2. Level 2: TAP limited expansion – to an actually built total capacity entry Kipoi of 45.3 MSm³ per day (440 GWh/day) (Limited Expansion Project)
3. Level 3: TAP partial expansion – to an actually built total capacity entry Kipoi of 52.7 MSm³ per day (512 GWh/day) (Partial Expansion Project)
4. Level 4: TAP full expansion – to an actually built total capacity entry Kipoi of 62.6 MSm³ per day (608 GWh/day) (Full Expansion Project)

It is worth emphasizing that TAP expansion is included in the REPowerEU plan by the European Commission.

6.6 Requests for incoming connections for TAP in Albania

In addition to the non-binding capacity requests, TAP has received the following non-binding connection requests:

³ It is the Participant's responsibility to initiate any procedures that may be necessary to make the downstream capacities of the TAP available. TAP makes no representation as to the availability of such capacity or the existence of required facilities outside TAP. TAP makes no representation as to the availability of capacity downstream of TAP or the existence of required facilities outside TAP.

⁴ TAP makes no representation as to the availability of capacity downstream of TAP or the existence of required facilities outside TAP.

an exit point in Relievi Roskovec, Albania with a technical capacity of about 7,500,000 KWh/d.

an exit point in Kucove, Albania with a technical capacity of about 7,500,000 KWh/d.

2 (two) non-binding connection requests in terms of Fier (with a required technical capacity for exit of about 7,500,000 kWh/d and for entry of 1.8 billion cubic meters per year respectively), potentially making the interconnection point two-way.

The DAR (Demand Assessment Report) concluded that the demand indicators received from TAP, SRG and DESFA were sufficient to initiate the design phase of a Capacity Expansion Project in accordance with paragraph 2 of article 26 of the NC CAM .

TAP has a strategic and essential role for decarbonization, security of supply and interconnection in Albania and SEE.

TAP plays an essential role in providing reliable access to a new source of natural gas from the Caspian Sea and a new route. TAP thus contributes to the diversification of sources and supply routes and can enable the gasification and decarbonization of South-eastern Europe and the Western Balkans, including that of Albania. TAP thus promotes access to cleaner and more affordable energy in the Western Balkans and increased gas penetration in not well-consolidated and/or new markets

TAP can also contribute significantly to the decarbonisation process by facilitating the decarbonisation of European economies by accelerating the phase-out of coal, particularly in South-Eastern Europe and the Western Balkans. TAP shall allow gas to replace the most polluting fuels in the region. To this end, TAP has been included by DG Neighborhood & Enlargement as a possible solution for decarbonisation as part of the energy transition from coal to gas in the Western Balkans.

Furthermore, in line with the objectives of the European Green Deal and decarbonisation objectives, it is planned that the TAP interconnector may also allow new renewable sources and/or any other low carbon gas (including hydrogen) from countries along the SGC, transported to Europe (including from decentralized production in Greece and Albania), creating an opportunity to connect significant volumes of H₂ to growing demand in Europe (both residential and industrial).

TAP reinforces its contribution to the decarbonisation objectives of the EU and the Energy Community through participation in various Important Projects of Common European Interest (IPCEI) for hydrogen initiatives. In Greece, TAP was pre-announced to participate in IPCEI's (Important Projects of Common European interest) Hydrogen Technologies and Systems Projects and then joined IPCEI's RHATL- (Regional Hubs And Their Links) project.

Last but not least, it is important to mention that TAP is closely monitoring the energy transition. As sustainability is one of TAP's top priorities, TAP has developed an energy transition strategy to contribute towards reaching the EU's net zero emissions target by 2050, while also ensuring that it plays a critical role in the EU's security of supply.

6.7 Southern Gas Corridor Operations and Energy Transition Forum.

The purpose of the Energy Transition and Operations Forum is to facilitate discussion, exchange of views, exchange of best practices between partners and promote their alignment. This forum is a

platform of cooperation between the main partners of the Southern Gas Corridor, on key topics including issues related to the energy transition for Southern Gas Corridor.

6.8 Carbon Management Plan 2022-2025

TAP has drafted its Carbon Management Plan as part of the Long-Term Energy Transition Strategy, as a guide for the company to contribute towards reaching the EU's target of net zero emissions by 2050. The Carbon Management Plan (CMP) contains emission sources, emission targets (GHG and Methane emissions) and detailed annual initiatives to achieve these targets and reduce TAP's carbon footprint from 2022-2025. The CMP identifies a number of studies, projects and initiatives to achieve this goal. Some examples can be found below:

- Hydrogen (material testing and re-certification of TAP assets).
- Electrification (connection to the public grid and reliability of energy sources).
- Biomethane (feasibility studies to partially or completely replace fuel gas).
- Sustainable mobility (travel compensation, car fleet replacement).
- Reduction of methane emissions (reduction of distant emissions, reduction of vents and incomplete combustion).
- Energy efficiency (reduction of energy use in TAP facilities).

Finally, we would like to emphasize the uniqueness of TAP from a regulatory point of view as a partially exempted interconnector, crossing the jurisdictions of Albania, as a Contracting Party of the Energy Community, which is actively aligning the national legislation with the substantive legislation of the EU for energy, the so-called "acquis communautaire", and of two EU member states (Italy and Greece).

TAP had and shall continue to have a successful cooperation with ERE on the above issues and shall ensure continued compliance with the conditions set for TAP in the Transmission License granted by ERE.

TAP shall also continue to fulfill any other obligations arising from the decisions issued by ERE or from the laws approved by the Parliament of Albania.

In the TAP Market Test for 2021-2022, there was increased interest in capacity and connections in Albania.

The Market Test for capacity expansion has already started. It is harmonized with the provisions of the Final Joint Opinion of the Energy Regulators on the Application of the Exemption of TAP AG, dated 6 June 2013, issued by the Authorities under Directive 2009/73/EC, ('Final Joint Opinion') of the Tariff Code of TAP 5 with EU Regulation 2017/459 creating the network code on Capacity Allocation Mechanisms for gas transport systems ("CAM NC").

According to Paragraph 4.1.7 of the Final Joint Opinion, the Guidelines are approved by the competent Regulatory Authorities of Italy, Greece and Albania. ('Authorities'), respectively ARERA, RAE and ERE.

The mechanism to expand and give the opportunity to any interested party to submit a request for connection to the TAP gas pipeline including the territory of Albania is Market Testing. TAP has organized the first Market Testing in July 2019 and started another Market Testing in July 2021 and continues in 2022 and shall end in 2023.

6.9 By-laws approved by ERE during 2022 for the exercise of activity in the Natural Gas sector:

Decision no. 13 dated 26.01.2022 “On the request of Albgaz company to extend the term of ERE Board final decision on licensing Albgaz company for the operation activity in natural gas storage facilities.”

Based on Article 16, of Law no. 43/2015, "On Power Sector", as amended, Article 59, of Law no. 102/2015, "On Natural Gas Sector", as amended; article 53, point 3, of law no. 44/2015, "Code of Administrative Procedures of the Republic of Albania", as well as Article 15 of the “Regulation on ERE organization, Operation and Procedures”, approved by the decision of the Energy Regulatory Authority (ERE) Board no. 96, dated 17.06.2016; ERE Board, on their meeting dated 26.01.2022, reviewed the report with Protocol no. 128/1 dated 21.01.2022, prepared by the Technical Directories, with subject "On the request of "ALBGAZ" company to extend the term of ERE board decision on licensing "ALBGAZ" company for the operation activity in natural gas storage facilities”

"ALBGAZ" company addressed ERE through the official e-mail dated 20.01.2022, arguing that in the framework of completing the specific documentation for the license to operate natural gas storage facilities, it is currently working on the final report "EB20-ALB-ENE-01 Albania, Dumrea Underground Natural Gas Storage", which fulfills the unfulfilled requirements for this procedure. Under these conditions, the company requests the understanding of ERE to extend the term of ERE Board final decision on licensing Albgaz company for the operation activity in natural gas storage facilities, until 20.12.2022.

- Regarding the extension of procedural terms by the public body, law no. 44/2015, "Code of Administrative Procedures of the Republic of Albania", in article 53, point 3, cites that: "The procedural time limit specified by law or sub-legal acts may be extended only if this is explicitly provided in the law or sub-legal acts, whereas the time-limit set by the public body may be extended upon justified request of the interested party submitted prior to expiry of the time limit.”

⁵ Approved in November 2013 by the Italian, Greek and Albanian Regulatory Authorities. An amendment was also approved in July 2018

In conclusion, ERE Board decided as follows: To accept the request of "Albgaz" company to extend the term of ERE Board final decision on licensing Albgaz company for the operation activity in natural gas storage facilities, until 20.12.2022.

"ALBGAZ" company must report to ERE every three months from the approval of this decision, on the progress of the process for completing the missing documentation.

Decision no. 14 dated 26.01.2022 "On an amendment in ERE Board decision no. 187 dated 10.11.2017, "On licensing of "Albgaz" company in Natural Gas distribution activity" (as amended).

In support of Article 16, of Law no. 43/2015, "On Power Sector", as amended, Article 59, of Law no. 102/2015, "On natural gas sector", as amended; article 53, point 3, of law no. 44/2015, "Code of Administrative Procedures of the Republic of Albania", as well as Article 15 of the Regulation on the ERE Organization, Operation and Procedures, approved the Energy Regulatory Authority (ERE) Board decision no. 96, dated 17.06.2016; ERE Board, on their meeting dated 26.01.2022, reviewed the report with Protocol no. 128/2 dated 21.01.2022, prepared by the License, Authorizations and Supervision Directory and Natural Gas Directory, with subject "On an amendment in ERE board decision no. 187, dated 10.11.2017, "On licensing "ALBGAZ" company in Natural Gas distribution activity, as amended" on the approval of the amendment of point 1, of ERE Board decision no. 187, dated 10.11.2017, (as amended),

"ALBGAZ" company with official letter Protocol no. 93 dated 21.06.2021, protocolled at ERE with Protocol no. 764 dated 21.06.2021, informed that it has been provided with a "Preliminary EIA Decision", a document submitted at ERE and necessary for the application for equipment with an Environmental Permit, which remains in the process to be obtained during 2022.

- Regarding the condition related to the "Certificate of Insurance", "ALBGAZ" company informed that the relevant payment is foreseen in its budget for 2022 and shall be concluded throughout this year.
- The company requested to extend the term for fulfilling the condition related to the submission of the "Certificate of Insurance" in ERE, on a date with the condition set for the submission of "Permits and Environmental Authorizations" in ERE, thus, on 20.01 .2022.

In law no. 44.2015, "Code of Administrative Procedures of the Republic of Albania", in article 53, point 3, it is quoted that: "The procedural time limit specified by law or sub-legal acts may be extended only if this is explicitly provided in the law or sub-legal acts, whereas the time-limit set by the public body may be extended upon justified request of the interested party submitted prior to expiry of the time limit."

Regarding the above, ERE Board approved the following:

To license "Albgaz" company in the Natural Gas distribution activity, for a 30-year term, with the condition that within 12.21.2022, it shall submit the permits and environmental authorizations and the insurance certificate in ERE.

Decision no. 15 dated 26.01.2022 "On an amendment in ERE Board decision no. 187 dated 10.11.2017, "On licensing "Albgaz" company in Natural Gas transmission activity" (as amended).

Based on Article 16, of Law no. 43/2015, "On Power Sector", as amended, Article 59, of Law no. 102/2015, "On Natural Gas Sector", as amended; article 53, point 3, of law no. 44/2015, "Code of

Administrative Procedures of the Republic of Albania", as well as Article 15 of the Regulation on ERE Organization, Operation and Procedures, approved by the Energy Regulatory Authority (ERE) Board decision no. 96, dated 17.06.2016; ERE Board, on their meeting dated 26.01.2022, reviewed the report with Protocol no. 128/2 dated 21.01.2022, prepared by the License, Authorizations and Supervision Directory and the Natural Gas Directory, with subject "On an amendment in ERE board decision no. 187, dated 10.11.2017, "On licensing "ALBGAZ" company in Natural Gas transmission activity, as amended" on approving the amendment of point 1, of ERE Board decision no. 187, dated 10.11.2017, (as amended),

"ALBGAZ" company requested to extend the term for fulfilling the condition related to the submission at ERE of the "Certificate of Insurance", to a date with that of the condition established for the submission in ERE of " Permits and Environmental Authorizations".

- Regarding the extension of the procedural terms by the public body, law no. 44/2015, in the "Code of Administrative Procedures of the Republic of Albania", in article 53, point 3, it is mentioned that: "The procedural time limit specified by law or sub-legal acts may be extended only if this is explicitly provided in the law or sub-legal acts, whereas the time-limit set by the public body may be extended upon justified request of the interested party submitted prior to expiry of the time limit."

Regarding the above, ERE Board decided as follows:

1. To approve the amendment of point 1 of ERE board decision no. 188, dated 10.11.2017, amended as follows:

To license "Albgaz" company in Natural Gas transmission activity, for a 30-year term, on the condition that within 21.12.2022, it shall submit the permits and environmental authorizations and the insurance certificate in ERE"

Decision no. 17, dated 26.01.2022 "On an amendment in ERE board decision no. 179, dated 08.11.2017, " On the Certification of the Company Combined Natural Gas Operator, AlbGaz company, (as amended)."

Based on Article 16, of Law no. 43/2015, "On Power Sector", as amended, Article 59, of Law no. 102/2015, "On Natural Gas Sector", as amended; article 53, point 3, of law no. 44/2015, "Code of Administrative Procedures of the Republic of Albania", as well as Article 15 of the Regulation on ERE Organization, Operation and Procedures, approved by Energy Regulatory Authority (ERE) Board decision no. 96, dated 17.06.2016; ERE Board on their meeting dated 26.01.2022, after reviewing the report with Protocol no. 128 dated 21.01.2022 prepared by License, Authorizations and Supervision Directory and Natural Gas Directory, "On an amendment in ERE board decision no. 179, dated 08.11.2017, On the Certification of the Company Combined Natural Gas Operator, AlbGaz company, as amended, ERE Board observed that:

As for the condition related to the submission to ERE every fiscal year of information on the independence of financial auditors established by ERE Board, with decision no. 152, dated 30.06.2021, "Albgaz" company submitted the respective documentation and as such this condition is considered fulfilled/updated for 2020 and point 5.1 of decision no. 179/2017 remains unchanged.

For the condition related to inter-institutional cooperation for the implementation of changes in the legal framework, Article 11 and 46 (10), of the Law on Natural Gas Sector and the transfer of powers to the Ministry of Economy, "Albgaz" company informs that it has been in constant written and verbal communication with MIE in order to fulfill this condition. Also "Albgaz" company informs that it is close to reaching a solution accepted by the parties, and therefore requests from ERE to extend the term set in decision no. 152/2021, until 20.11.2022.

ERE Board decided: -“...To amend point 5.2, of ERE Board decision no. 179, dated 08.11.2017, (as amended), as follows:

"...5.2 "Albgaz" company shall take measures to present at ERE by 20.11.2022 documentary evidence for inter-institutional cooperation for the implementation of changes in the legal framework, article 11 and article 46, point 10, of the law "On Natural Gas Sector", as amended and the transfer of powers to the Ministry of Economy and Finance..."

Decision no. 45, dated 18.03.2022 “On approving some additions and amendments on TAP network code”

With the proposal of TAP AG company, referring to the TAP Network Code, approved with ERE Board Decision no. 97, dated 15.06.2020"; Article 22 of decision no. 97, dated 15.06.2020 of the Energy Regulatory Authority (ERE) Board, "On the approval of the TAP Network Code"; Directive 2009/73/EC of the Parliament and the Council of Europe, of July 13, 2009 "Regarding the Common Rules for the internal market of Natural Gas and the repeal of Directive 2003/55/EC"; Regulation of the Parliament and Council of Europe, 942/2019 of June 5, 2019, "On the establishment of a European Union Agency for the Cooperation of Energy Regulators"; Regulation of the European Parliament and Council 715/2009 of July 13, 2009 amended by the Commission Decision of August 24, 2012, EU Commission Regulation 312/2014 of March 26, 2014; "On the conditions for access to natural gas transmission networks"; EU Commission Regulation 2017/459 of March 16, 2014 "On the establishment of a network code for gas balancing of transmission networks; The decision of the European Commission dated May 16, 2013, which contains the "Exemption of the Tran Adriatic pipeline from the requirements for third-party access, tariff regulation and ownership sharing, defined in articles 9, 32, 41(6), 41 (8) and 41(10) of Directive 2009/73/EC; the provisions of the Final Joint Opinion of the Energy Regulators on the Application of the Exemption of TAP AG, dated June 6, 2013, issued by the Authorities under Directive 2009/73/EC, (Final Joint Opinion), Article 4.7.1 of the Final Joint Opinion; the provisions of Regulation 715/2009 and the European Network Codes which are not in conflict with the Final Joint Opinion; addressed to the Regulatory Authorities, for some amendments in the Network Code recorded in Annex A that were related to:

Functional additions to make more efficient the necessary formalities for obtaining and maintaining the status of "registered user", necessary to request the distribution of transport capacity; -

The introduction of provisions aimed at strengthening and making more efficient the safeguards to guarantee the exposure of TAP AG to users; -

The introduction of provisions allowing the management of a transport service in terms of volumes of gas injected upstream by defining a new virtual entry point that includes the physical points of Komotini and Nea Mesimvria.

As well as the Update of the official proposal of TAP AG on March 7, 2022, with the final version of the TAP Network Code, as well as the request to the three Regulatory Authorities, namely ERE (Albania), RAE (Greece) and ARERA (Italy), for approval of amendments in the TAP network code, based on Article 22 of the "TAP Network Code", ERE Board decided:

To approve together with the Regulatory Authorities of Italy (ARERA) and Greece (RAE), the amendments to the TAP Network Code reported in Annex B, based on the common reasons set out in Annex A.

Decision no. 106, dated 19.05.2022 " On approving the Regulation for the Use of the Liquefied Natural Gas Terminal (LNG)”

This Regulation is drafted pursuant to Article 16, Article 74, Articles 82 to 88 of Law No. 102/2015, "On Natural Gas Sector" as amended, as well as in accordance with the "Natural Gas Transmission

Network Code" and "Natural Gas Metering Code".

The regulation on the use of the liquefied natural gas terminal defines a set of rules that establish the operation of the liquefied natural gas terminal, and specifically determines how the activities shall be carried out and how the operators of the LNG system shall cooperate taking into account the general technical-economic rules related to: 1. Characteristics and technical conditions; 2. Construction, maintenance and operation of the LNG terminal; 3. Contractual relations and general terms of use of the LNG terminal; 4. Reservation and use of LNG Terminal Capacity; 5. Metering rules and distribution rules; 6. Publication and exchange of LNG Terminal data.

For all of the above: In support of Article 16, of Law no. 43/2015, "On Power Sector", as amended, articles 16, 17 and 74, of law no. 102/2015, "On natural gas sector", as amended; Article 16 of the Regulation on ERE organization, operation and procedures, approved with the Energy Regulatory Authority (ERE) decision no. 96, dated 17.06.2016; ERE Board, on their meeting dated 19.05.2022, after reviewing the report prepared by the Technical Directories with no. 668/8 prot. dated 17.05.2022, decided

On the approval of the Regulation for the Use of the Liquefied Natural Gas Terminal (LNG) with Decision no. 106, dated 19.05.2022.

Decision no. 152 dated 13.06.2022. On an amendment in ERE Board decision no. 15, dated 31.01.2019 "On licensing Trans Adriatic Pipeline AG Albania in the natural gas transmission activity, registered at the National Registering Center (QKB) as a branch of the foreign joint stock company of Trans Adriatic Pipeline

ERE Board, on their meeting dated 13.06.2022, after reviewing the report with Protocol no. 910/1 dated 10.06.2022, prepared by the technical directories of ERE, On an amendment in ERE Board decision no. 15, dated 31.01.2019 "On licensing Trans Adriatic Pipeline AG Albania in the natural gas transmission activity, registered at the National Registering Center (QKB) as a branch of the foreign joint stock company of Trans Adriatic Pipeline", it was observed that: "Trans Adriatic Pipeline Ag Albania" company, through official letter Protocol no. LT-TAP-ERE-00038, dated 11.04.2022, informed that it has secured a part of the servitude and land ownership for the above-ground structures through voluntary agreements and the remaining part of the ownership and servitude rights, acquired through the process of expropriation, have passed to the Ministry of Infrastructure and Energy (MIE) and shall then be transferred to TAP (in application of letters (h) and (i), Part 2, Appendix 1 of the Agreement with the Government of the Host country (MQP). The company also states that it has already secured all the rights over the land and is at the end of the process of registering these rights with the relevant local cadastre directorates, a process which, due to its complexity, has not terminated yet. TAP AG company also suggests to consider the possibility of the amendment of ERE board decision on the Transmission License, removing the condition provided for in point 2 of ERE board decision No. 15, dated 31.01.2019, "On licensing Trans Adriatic Pipeline AG Albania in the natural gas transmission activity, registered at the National Registering Center (QKB) as a branch of the foreign joint stock company of Trans Adriatic Pipeline, arguing that: - When the voluntary agreements have not been possible, all ownership rights have been secured in cooperation and with the support of MIE. On this basis and within the provisions of the Agreement with the Government of the Host country (MQP), MIE has granted TAP with Certificate of Use for all sections of the gas pipeline and its respective structures, which guarantees that the rights over the land are secured and that TAP can to operate the gas pipeline. Regarding the above, ERE Board decided:

To amend point 2 of the provision of ERE no. 15, dated 31.01.2019, "On licensing Trans Adriatic Pipeline AG Albania in the natural gas transmission activity, registered at the National Registering Center (QKB) as a branch of the foreign joint stock company of Trans Adriatic Pipeline" as amended,

as follows: "It is done: 2. No later than 01.07.2024, the company submits at ERE the complete documentation, showing the ownership titles on the assets it has to perform the functions or fulfill the obligations under the required license in the territory of Albania, according to the provisions of law no. 107/2021 "On Co-governance".

Decision no. 185, dated 21.07.2022 "On approving the Methodology for calculating the tariff for the natural gas storage system service"

The methodology of calculating the tariff on the way of calculating the tariff for the natural gas storage system service is based on clear principles of calculating the costs related to this service, for determining fair and transparent prices, in accordance with the regulatory acts approved by ERE. The methodology for calculating the tariff for the natural gas storage system service is aimed at determining the criteria, conditions and way of calculating the tariff for the natural gas storage system service (injection, storage and withdrawal of natural gas), based in clear principles of calculating the costs related to this service for the determination of fair and transparent prices, in accordance with the regulatory acts approved by ERE, carried out by the licensed operator of natural gas storage system.

This methodology defines the natural gas storage service tariffs and is applied by Storage System Operators, who are legal entities, licensed by ERE, and that; a) carry out the storage activity and are responsible for the operation of natural gas storage facilities according to Article 59 of Law no. 102/2015 "On Natural Gas Sector"; b) have received approval for the use of existing plants of the system, in accordance with Article 11 and Article 59 of Law 102/2015 "On Natural Gas Sector", as amended; c) implement general rules for access and service provision to users of the storage facilities and who are subject to monitoring by ERE, according to Article 64, letter c) of Law 102/2015 "On Natural Gas Sector", as amended; d) provide, for the users of the storage facilities, separate and undivided services of the storage space, injection and withdrawal of natural gas, according to the signed contracts, based on Article 67 of Law 102/2015 "On Natural Gas Sector" , as amended;

Decision no. 270, dated 02.11. 2022 "On the approval of the Project Proposal of TAP, SRG and DESFA for the incremental capacity process 2021- October 2022" Proposed by TAP AG and attached as Appendix B

Considering that, pursuant to Article 4.1.7, TAP AG is obliged to fulfill the mandatory capacity requirements resulting from any market test taking into account the provisions of points 3, 6 and 9 of §4.7 of the Final Joint Opinion. The expansion takes place if it is economically sustainable, namely if the additional revenue from the capacity resulting from each market test is equal to or greater than the efficient incremental costs, determined according to the methodology of TAP AG as defined in the TAP Tariff Code. • On June 28, 2021 (ARERA Review 273/2021/R/gas), ERE Decision No. 151, dated 29.06.2021, RAE Decision 571/2021) respectively ARERA, ERE and RAE approved the " Guidelines for the 2021 Market Test of Trans Adriatic Pipeline". The main points of the Guidelines relevant to this decision are:

- Interested parties must submit a statement to the Authorities to ensure that their non-binding request indicator complies with any applicable Capacities; they must also confirm to TAP AG, at least two weeks before the end of the Assessment Phase, that the Authorities have considered the request in line with the capacity limits.
- The binding phase is foreseen in the proposed Guidelines because its detailed rules shall depend on the requests received during the non-binding phase and shall be subject to further approval by the Authorities. On October 31, 2022, TAP AG, SRG and DESFA submitted a joint Project Proposal for approval to the Authorities, in accordance with the provisions set forth in Article 28 of the CC of

October 2022" concerns 7 (seven) Interconnection Points (IP) along the TAP route: Kipoi (TR-GR), Nea Mesimvria (GR), Komotini (GR), Kuçovo (AL), Relievi Roskovec (AL), Fier (AL), and Melendugno (IT). This Project Proposal, for the part of Albania, includes the following:

Additional capacity offers from TAP at the future exit point of Kuçova as separate exit capacity;

Additional capacity offers from TAP at the future exit point of Fier as unbundled exit capacity;

Additional capacity offers from TAP at the future entry point of Fier as unbundled entry capacity;

The additional capacity provided by TAP as unbundled exit capacity in the relevant future exit points of Relievi Roskovec.

For all of the above, ERE Board decided:

To approve the Project Proposal of TAP, SRG and DESFA for the incremental capacity process 2021-October 2022" Proposed by TAP AG submitted by TAP AG, SRG and DESFA with official letter dated 31 October 2022 (Appendix B) " as stated in the joint decision with Italy and Greece, respectively ARERA and RAE (Appendix A);

Decision no. 326, dated 14.12.2022 "On letting into force the temporary tariff for the transmission of natural gas from Albغاز company for 2023"

ERE with official letter Protocol no. 1471 dated 18.08.2022 "Request for information" addressed to "Albغاز" company to take measures to fulfill the obligations, in implementation of the legal and by-laws in force. "Albغاز" company with official letter Protocol no. 101/1 dated 21.09.2022 responded to the above-mentioned request, emphasizing that in the circumstances in which the company carries out its daily activity as OST-G, there have been no significant developments that would directly affect the elements of who determine the tariff methodology and, in the end, Albغاز company requested that for 2023 the current transmission tariff remains in force.

From the above, based in articles 13 point 1, 16 point 2, 17 letter "e" and article 33 of law no. 102/2015, "On natural gas sector" as amended; Article 21 of the Regulation on ERE organization, operation and procedures, approved with the Energy Regulatory Authority (ERE) Board decision no. 96, dated 17.06.2016; "Methodology for tariff calculation of natural gas transmission and distribution network", approved with ERE board decision no. 178, dated 18.11.2017; ERE Board, on their meeting dated 14.12.2022, as well as after reviewing the report with Protocol no. 2061/2 dated 12.12.2022, prepared by the Tariff and Prices Directory "On letting into force ERE board decision no. 206, dated 16.12.2019, "On approving the temporary tariff for the transmission of natural gas by ALBGAZ company for 2023", was observed as follows:

"Albغاز" company with official letter Protocol no. 99/1, dated 5.12.2022, has informed that it is working closely with international experts in the field who, based on the best international practices, are drawing up the company's short-term and long-term investment plan, where the expected results shall be fully in accordance with articles 7 and 8 of the regulation on the procedures of submitting and approving the investment plans from the natural gas transmission and distribution operators, as well as with the submission of the investment plan where the factual evidence on company assets shall be presented.

"Albغاز" company also declares that it is still at an early stage regarding the possibilities of cooperation with other local or foreign parties and in the case of signing binding agreements with other parties, it shall inform in advance in a written form at ERE in application of the legal and regulatory provisions in force.

In conclusion, the company requests the extension and unification of the deadlines provided by ERE in the aforementioned official letter until 30.06.2023. Until the moment of submitting the company's application for the approval of a tariff for the transmission of natural gas based on the provisions of the legislation in force, it becomes necessary to extend the legal force of decision no. 206 dated 16.12.2019.

For all of the above, ERE board decided:

Letting into force the temporary natural gas transmission tariff from Albgaz company for 2023., approving the extension of the legal force of decision no. 206, dated 16.12.2019 of ERE Board for 2023, until the approval of a tariff based on the findings of ERE for Albgaz" company according to the provisions of the legislation in force

Decision No. 344, Dated 21.12.2022 On the suspension of ERE Board decision regarding the request of "Albgaz" company for the postponement of the procedural deadline of ERE Board decision on the licensing of "Albgaz" company in operating natural gas storage facilities activity

"ALBGAZ" company addressed ERE through the official e-mail on 20.01.2022, arguing that in the framework of completing the specific documentation for the license to operate natural gas storage facilities, it is currently working on the final report which fulfills the unfulfilled requirements for this procedure. Under these conditions, the company requests the understanding of ERE for the postponement of the procedural deadline of ERE Board decision on the licensing of "Albgaz" company in operating natural gas storage facilities activity, until 20.12.2022. For the above, since the request of "ALBGAZ" company for postponement of the deadline for filing the relevant documentation was filed in accordance with the legislation in force, within the deadline established in ERE board decision no. 195, dated 22.09.2021 and taking into account the efforts of "ALBGAZ" company to fulfill the respective conditions, we estimate that the company's request should be accepted. ERE Board decided

"To suspend ERE Board (Decision No. 13, dated 26.01.2022- "On the request of "Albgaz" company to postpone the procedural deadline for the decision-making of ERE Board decision on the licensing of "Albgaz" company in operating natural gas storage facilities activity until the completion of all missing documentation.

Decision No. 345, Dated 21.12.2022 "On some amendments in ERE Board decision no. 171, dated 16.08.2021, "On some amendments in ERE Board decision no. 171, dated 16.08.2021, "On approving the compliance program of the natural gas transmission system operator, "Albgaz" company", as amended.

ERE Board with decision no. 171, dated 16.08.2022, has decided: 1. To approve the Compliance Program of the Transmission System Operator for Natural Gas, "ALBGAZ" company, on the condition that the company within 3 months submits it at ERE updated with the determinations according to the requirements of point 5, point 6 and point 15, of the Compliance Program of the Transmission System Operator for Natural Gas, approved with ERE board decision no. 77, dated 26.05.2017.

1.Failure to fulfill the condition according to the provisions of point 1 constitutes a reason for the review of this decision

- Following and based on the request of "ALBGAZ" company, ERE board with decision no. 236, dated 26.11.2021 decided: 2 To extend for 3 (three) months, starting from the entry into force of this decision, the term defined in point 1, of ERE Board decision no. 171, dated 16.08.2021, "On

approving the compliance program of the natural gas transmission system operator, "Albgaz" company".

In the following, based on the discussions held at the hearing session held on 11.04.2022, at 11:00 a.m. near the premises of the Energy Regulatory Authority, the correspondence developed with "ALBGAZ" company and the evaluation of the Compliance Program as a whole, it is estimated that the task should be left to "ALBGAZ" company to implement the obligations derived from the legal and by-laws in force.

For all of the above, ERE board decided:

1. Point 1 of ERE board decision no. 171, dated 16.08.2021 as amended, changes and becomes: 3
 1. To approve the Compliance Program of the Transmission System Operator for Natural Gas, "ALBGAZ" company
 2. Point 2 of ERE board decision no. 171, dated 16.08.2021, as amended, changes and becomes: 2. "ALBGAZ" company must implement the obligations derived from the legal and by-laws in force, in terms of: a) the relations of the shareholders of "ALBGAZ" company with companies engaged in the production and/or supply of natural gas and electricity, or those that have any commercial interest (item 5 of the Compliance Program of "ALBGAZ" company)
 - a) unbundling and independence of public bodies which are authorized to represent the rights of state shares on the one hand and companies engaged in production and supply on the other hand (item 6 of the Compliance Program of "ALBGAZ" company).

Decision No. 352, Dated 28.12.2022 "On an amendment in the ERE Board decision no. 187 Dated 10.11.2017, "On Licensing Albgaz Company in Natural Gas Distribution activity", (as amended)

With official letter Protocol no. 130/4 dated 06.04.2022, ERE has requested from the National Environment Agency (AKM) information on what environmental permit/authorization a company should be provided with in order to exercise, among other things, natural gas distribution activity, where the exercise of these activities is carried out with the relevant assets. As well as the position/interpretation of AKM regarding the validity of the decision for preliminary EIA, while "ALBGAZ" company declares that the pipeline installations are the existing ones and in accordance with article 3, point 10 of law no. 10 448, dated 14.07.2011 "On environmental permits" as amended, this installation is treated as a new installation, so this EIA is also valid.

-With official letter Protocol no. 2798/1 dated 22.04.2022, AKM, has brought to attention that "ALBGAZ" company has been provided with the EIA as mentioned above and informed that: If the project, which has been signed to the EIA process, does not start implementation on the ground within 2 years from the date of approval of the environmental statement or the decision on the preliminary EIA, then these documents are considered invalid and the EIA process starts over. With the email registered in ERE with Protocol no. 1902/2 dated 19.12.2022, "ALBGAZ" company informed that according to the conditions established in the preliminary EIA for the existing installations of active transmission/distribution pipelines, the company has drafted and sent periodic monitoring reports to AKM, which were also made available for ERE and that from AKM there was no objection regarding the form or content of these reports. For all of the above, it results that the company has fulfilled the condition established in point 1 of decision no. 187, dated 10.11.2017, as amended, and point 1 of decision no. 188, dated 10.11.2017, by submitting at ERE, the relevant preliminary EIAs. In these circumstances, the company has requested the understanding of ERE for the postponement of the

deadline for fulfilling this condition until 20.12.2023.

As above, ERE Board in support of Article 16 of Law no. 43/2015, "On Power sector", as amended; Article 80 of Law no. 102/2015, "On natural gas sector", as amended; article 53, point 3, of law no. 44/2015, "Code of Administrative Procedures of the Republic of Albania"; as well as Article 15 of the Regulation on ERE organization, operation and procedures, approved with the Energy Regulatory Authority (ERE) Board decision no. 96, dated 17.06.2016; ERE Board, on their meeting dated 28.12.2022, after reviewing the report protocol no. 2116/2 dated 21.12.2022, prepared by the Technical Directories of ERE, "On an amendment in ERE Board decision no. 187, dated 10.11.2017, "On licensing "Albgaz" company in the natural gas distribution activity", as amended. Decided:

"To change point 1 of decision no. 187, dated 10.11.2017, (as amended) as follows: 1. "To license "Albgaz" company. in natural gas distribution activity, for a 30-year term, with the condition that within 30.04.2023, it shall submit the Insurance Certificate at ERE."

Decision No. 353, Dated 28.12.2022 "On an amendment in ERE Board decision no. 188 dated 10.11.2017, "On licensing ALBGAZ company in natural gas transmission activity", as amended

With official letter Protocol no. 130/4 dated 06.04.2022, ERE has requested from the National Environmental Agency (KTA) information on what environmental permit/authorization a company must be provided with to exercise, among other things, natural gas distribution activity, where the exercise of these activities is carried out with the relevant assets. As well as the position/interpretation of KTA regarding the validity of the decision for preliminary EIA, while "ALBGAZ" company declares that the pipeline installations are the existing ones and in accordance with article 3, point 10 of law no. 10 448, dated 14.07.2011 "On environmental permits" as amended, this installation is treated as a new installation, so this EIA is also valid.

-With official letter Protocol no. 2798/1 dated 22.04.2022, KTA, has brought to attention that "ALBGAZ" company has been provided with the EIA as mentioned above and informed that: If the project, which has been signed to the EIA process, does not start implementation on the ground within 2 years from the date of approval of the environmental statement or the decision on the preliminary EIA, then these documents are considered invalid and the EIA process starts over. With the email registered in ERE with Protocol no. 1902/2 dated 19.12.2022, "ALBGAZ" company informed that according to the conditions established in the preliminary EIA for the existing installations of active transmission/distribution pipelines, the company has drafted and sent periodic monitoring reports to KTA, which were also made available for ERE and that from KTA there was no objection regarding the form or content of these reports. For all of the above, it results that the company has fulfilled the condition established in point 1 of decision no. 187, dated 10.11.2017, as amended, and point 1 of decision no. 188, dated 10.11.2017, by submitting at ERE, the relevant preliminary EIAs. In these circumstances, the company has requested the understanding of ERE for the postponement of the deadline for fulfilling this condition until 20.12.2023.

As above, ERE Board in support of Article 16 of Law no. 43/2015, "On Power sector", as amended; Article 80 of Law no. 102/2015, "On natural gas sector", as amended; article 53, point 3, of law no. 44/2015, "Code of Administrative Procedures of the Republic of Albania"; as well as Article 15 of the Regulation on ERE organization, operation and procedures, approved with the Energy Regulatory Authority (ERE) Board decision no. 96, dated 17.06.2016; ERE Board, on their meeting dated 28.12.2022, after reviewing the report protocol no. 2116/2 dated 21.12.2022, prepared by the Technical Directories of ERE, "On an amendment in ERE Board decision no. 187, dated 10.11.2017, "On licensing "Albgaz" company in the natural gas distribution activity", as amended. Decided:

1. *"To change point 1 of decision no. 187, dated 10.11.2017, (as amended) as follows: 1. "To license "Albgaz" company. in natural gas transmission activity, for a 30-year term, with the condition that within 30.04.2023, it shall submit the Insurance Certificate at ERE."*

Decision No. 354, Dated 28.12.2022 "On an amendment in ERE board decision no. 179, dated 08.11.2017, "On the Certification of "Albgaz" company as the combined operator in natural gas, as amended

With official letter Protocol no. 85/4 dated 04.04.2022, addressed to "ALBGAZ" company for the information of MIE and MF, ERE has reminded the "ALBGAZ" company of the obligation to report at ERE on the measures taken by to meet the conditions of decision no. 179/2017, as amended. cit, 5.2 "ALBGAZ" company to take measures to submit at ERE by 20.11.2022 the documentary evidence for inter-institutional cooperation for the implementation of changes in the legal framework, article 11 and article 46, point 10, of the law "On Natural Gas Sector", as amended and the transfer of powers to the Ministry of Finances and Economy.

- Regarding the condition established in point 5.1 of ERE board decision no. 179/2017, as amended, related to the submission at ERE every fiscal year of information on the independence of financial auditors, "Albgaz" company has presented the respective documentation and as such this condition is considered fulfilled/updated for 2021 and point 5.1 of this decision remains unchanged.

-For the condition established in point 5.2 of ERE Board decision no. 179.2017, as amended, related to inter-institutional cooperation for the implementation of changes in the legal framework, article 11 and 46 (10), of the law "On natural gas sector" as amended and the transfer of powers to the Ministry of Economy, " Albgaz" company has informed that the fulfillment of this condition is beyond its will, but it will take the necessary steps to address to MIE the finding of an all-accepted solution within the legal framework. Also, the company has announced that it is taking concrete steps towards a possible partnership with foreign companies (MoU with ENAGAS), which have extensive experience in the natural gas sector, which shall also lead to the reconfiguration of the representation of capital of the company. In these circumstances, the company has requested the postponement of the deadline for fulfilling this condition until 20.11.2023. After reviewing the report with Protocol no. 2116/1 dated 21.12.2022, of the Technical Directories of ERE, ERE Board decided:

1. To change point 5.2 of the decision of the ERE board no. 179, dated 08.11.2017, amended as follows:

5.2 "ALBGAZ" company shall take measures to submit at ERE by 20.11.2023 the documentary evidence for inter-institutional cooperation for the implementation of changes in the legal framework, article 11 and article 46, point 10, of the law "On Natural Gas Sector", as amended and the transfer of powers to the Ministry of Finances and Economy. Decision No. 355, Dated 28.12.2022 "On the prior approval of the compliance officer of "Albgaz" company.

Decision no. 355, dated 28.12.2022 On the prior approval of the compliance officer of "Albgaz" company

Based on Article 16, of Law no. 43/2015 "On power sector", as amended; article 47, point 2, of law no. 102/2015 "On natural gas sector"; Article 15 of the Regulation on ERE organization, operation and procedures, approved with the Energy Regulatory Authority (ERE) Board decision no. 96, 17.06.2016; ERE Board, on their meeting dated 28.12.2022, reviewed the report with Protocol no. 2116 dated 21.12.2022, of the Technical Directories of ERE, "On the prior approval of the Compliance Officer of "ALBGAZ" company.

With official letter protocolled at ERE with Protocol no. 1902 dated 03.11.2022, "ALBGAZ" company submitted the request and documentation for the prior approval of the Compliance Officer, Mr. Elvis Ponari, informing that this candidacy was selected after a preliminary process, where the fulfillment of the criteria was verified on his part.

–In article 47, point 2 of the law no. 102/2015 "On natural gas sector", as amended, it is determined that: The compliance officer is appointed by the supervisory council or, if such a body has not been established, by the collective management body of the TSO, after prior approval by ERE. Therefore, ERE decided:

"To prior approve Mr. E.P as Compliance Officer of "Albgaz" company.

6.10 ALBGAZ company throughout 2022

In the framework of the latest developments and the announced priorities of the Government of Albania, throughout 2022, represented by the Ministry of Infrastructure and Energy regarding the creation of a terminal for the distribution of liquefied natural gas (hereinafter referred to as "LNG") or the construction of a natural gas pipeline from Vlora Terminal to Fier, there has been an increased interest from foreign companies (it is worth emphasizing with many years of consolidated experience in the natural gas market) that seek to cooperate with "Albgaz" company for various projects in this sector.

Starting from the aforementioned projects, as well as from the commitment made to find alternative solutions for supplying Albania with natural gas, the Spanish company Enagas, through the formalized official letter "Cooperation Agreement" following the Memorandum of Understanding regarding "Albgaz" company has begun to cooperate in projects related to natural gas and LNG infrastructure.

Albgaz company has necessary and required the financial and technical support, in order to optimize and realize commercial projects and ventures. Such support shall have to be provided through partnership with international companies, with extensive experience in the field of natural gas infrastructure, not only in terms of design but also subsequent activities such as its operation and maintenance.

Cooperation with an important international actor would bring improvements in all aspects of the activity, including the technical, financial, as well as the absorption and provision of best experiences and practices in the sector, this also for the subsequent activities of infrastructure construction, such as operation and maintenance, which require financial but also human capacities with in-depth expertise in the sector.

They must be achieved in the short and medium term.

In fulfillment of MIE's strategy with Albgaz and KESH regarding:

The restoration of the Vlora TPP (Thermal Power Plant), the creation of a terminal for the distribution of liquefied natural gas, as well as the construction of a natural gas pipeline from the Vlora Terminal to Fier, Albgaz company has made available all the capacities of for exploring the possibilities of realizing projects.

The geographical position of Albania, as well as other factors such as:

completion of construction and start of TAP operations,

(ii) the difficult international situation of gas supply due to the Russian aggression in Ukraine, the need to diversify sources of energy supply, as well as the determination of the Government of Albania to support the gasification of the country, are the main factors that create a momentum for the development of the gas market in Albania.

Albgaz company in order to make it possible to optimize the created conditions, has important projects planned, where for their realization it has signed several cooperation agreements (MOU) with prestigious international companies for partnership and exploring the possibilities of project realization, which are following the Memorandum of Understanding dated 12.03.2021 between the Ministry of Infrastructure and Energy (MIE) and Excelerate Global Operations LLC and ExxonMobil LNG Market Development Inc;

Memorandum of Understanding dated 09.08.2022 between Albgaz company and Excelerate Global Operations LLC and ExxonMobil LNG Market Development Inc;

Memorandum of Understanding dated 14.05.2022 between Albgaz company and Overgas company;

Memorandum of Understanding and preservation of confidentiality between Albgaz company; SNAM s.p.a.; Total Energy and Enagas.

Memorandum of Understanding and Cooperation Agreement between Albgaz company and Enagas company;

The parties in these agreements of understanding aim to explore the ways of possible cooperation for the construction and realization of these projects.

Projects targeted by ALBGAZ company

Albgaz company during this period, operated at a time when natural gas was not considered a transitory source towards the goal of providing green energy and was therefore outside the European agenda, making the resources for financing projects in the field of transmission of gas to be drastically limited. But as pointed out above, the difficult international situation of gas supply due to the Russian aggression in Ukraine returned attention to natural gas, reconsidering it as a transitory source of energy, so this fact is closely related to our immediate internal need for diversification of energy sources.

For this reason, Albgaz, and in interaction with other consolidated actors in wider Europe, have engaged in the creation of **a regional hub in Vlora**. The aim is to coordinate the efforts and share the roles of each actor in this configuration of the gas sector which responds not only to the energy challenges at the national level but also at the regional level.

In the following, the projects, of which Albgaz is a part, shall be ranked according to priority, in the role as a combined gas operator, investor or as a strategic partner.

The LNG terminal in Vlora.

The LNG import terminal in Vlora shall serve to host dedicated natural gas loading and regasification vessels. The terminal shall be supplied with LNG through Floating Storage Regasification Units (FSRU). FSRU is a large LNG "tanker", which performs unloading, regasification, temporary storage operations. This floating unit is moored at the terminal and connected to the transmission network, where the regasified gas is injected for transmission along the pipeline. The FSRU has been booked to dock at this terminal and shall supply the terminal with up to 5 bcm/year. Albgaz company intends to invest in this infrastructural work in a certain percentage of the quotas of the work.

Vlore-Fier pipeline (Interconnection with TAP)

The Vlora Hub (node) provides that the LNG Terminal shall serve as a supply point between liquefied gas and customers. For this purpose, in addition to the presence of a key customer such as the Vlora TPP, significant quantities of gas must be contracted from suppliers (shippers) through a pipeline that connects the terminal with the connecting node of TAP. To enable this interconnection, the Vlorë-Fier pipeline has been designed, with a length of about 46 km, and which shall be redesigned in terms of the technical parameters of the transmission capacity, to optimally accommodate the supply volumes from the FSRU. Albgaz company intends to own a significant part of the quotas in the pipeline and shall operate in this asset together with any partner agreed according to the transmission license, recognized and certified by the Regulatory Body. As it is expected that the implementation and application shall start in 2023 and the commissioning can be realized within the 2024 or at the beginning of 2025. The detailed project of the pipeline, according to the modified parameters, with a pipe diameter of 24" and in parallel work is being done with ESIA and expropriations (LEA).

An infrastructural asset closely related to the pipeline is the Fier Exit Point. According to the HGA Agreement, TAP has built and delivered through the "Handover Agreement" the Exit Point, designed for a volume of 0.7-1.8 bcm. In the meantime, the detailed design of this Exit Point is being worked on in order to accommodate the new requirements arising from the increase in transmission volume up to 5 bcm/year.

Vlore Pipeline- Vlore TPP

A 2 km long pipeline shall connect the point from the terminal to the entry point to the TPP, to supply according to the "Gas-to-Power" model. It remains to be determined whether it shall be a separate line or a branch of the Vlorë-Fier pipeline.

Small Scale LNG Plant (SS LNG)

The "onshore" import terminal shall accommodate the necessary infrastructure for LNG storage and unloading operations, through prefabricated cryogenic tanks. Next, LNG is distributed by means of cargoes, the capacity of which varies from 20,000-34,000 m³, with a discharge capacity of 5,000 m³/hour. The terminal operator shall also undertake Small Scale LNG operations, insofar as they coincide with the internal activities of the terminal, without engaging in small scale distribution, respecting the regulatory conditions. Small-scale distribution shall start in a second moment, estimating a volume of 0.9 bcm in 2025 to 1.6 bcm in 2030 (domestic consumption plus exports).

Ionian Adriatic Pipeline (IAP)

IAP Section: Fier-Kashar

The Ionian-Adriatic pipeline, which shall be connected to TAP at the connecting node in Fier, shall cross about 170 km in the Albanian territory, to continue further north through Montenegro, Bosnia-Herzegovina and to end in Croatia where it shall connect to the Croatian transmission system, Plinacro. The capacity shall be designed to transmit up to 5 bcm. The technical parameters are: 32" (pole) for the diameter, 75-85 bar. It is expected to increase the capacity up to 7 bcm/year

The shareholders of this pipeline shall be the 4 relevant transmission operators of each country where the pipeline shall pass, with equal ownership quotas of 25%. Currently, the commitment of each entity is expressed through the drafting of the Shareholder Agreement, which is expected to be signed soon, thus establishing the "IAP" Project Company.

In the territory of the Republic of Albania, the Fier-Kashar section shall begin to be designed, with a

length of 84 km, and an investment value of 150 Million Euros. Pre-FEED and FEED shall be undertaken in 2025, and shall conclude with commissioning in 2030. We emphasize that Kashar shall also be the connection point for the gas supply of the city and the surroundings of Tirana. A very promising project.

IAP Section: Kashar-Montenegro

This section covers a length of about 86 km, from Kashari to the border point with Montenegro. The expected value of the investment is 165 million Euro. The Feasibility Study has been carried out, while in the time frame during 2025 to 2026, Pre-FEED and FEED are expected to be carried out, to conclude with the commissioning of the asset in 2030.

Dumrea underground natural gas storage

Another important project related to the gas infrastructure is the construction of a natural gas storage facility in the Dumrea area, which is planned to be realized in two phases, based on the cooperation between Albgaz company and SNAM, which is expected to start with the creation of a structure divided into two storage sites with a combined capacity of 230 m³/h of gas, while the second phase foresees the expansion of this structure up to the capacity of 800 m³/h of gas, giving it a regional dimension. We emphasize that the storage of natural gas in the summer period is a necessity for customers during the winter period. Dumrea region, the salts located in this area are ideal for storage. This storage shall serve our entire region, this makes even more profitable this potential project.

Interconnection with RMV

An important project is also the interconnection between the transmission systems of Albania and North Macedonia. With a length of about 60 km, this investment shall be carried out by Albgaz company. The implementation period shall last from 2025 to 2028, where the expected long-term capacity is expected to reach 0.3 bcm.

Gasification of the city of Korça

Today, the city of Korça, as a city with a relatively cold climate, is heated mainly with firewood and a small part with electricity. Considering the fact that the TAP pipeline passes 3 km away from the city, it constitutes a real premise for gas heating of the city. In the TAP project, it is foreseen that one of the connection points (Connection Point CP) for the network in Albania shall be near the city. Further, the construction of the high pressure network from this point CP to the entrance of the city (PRMS) is the obligation of the Transmission System Operator for Gas OST-G.

The prospective gas distribution system shall be supplied by pressure reducing and metering stations (PRMS) which are planned to be located near major consumption centers in Albania. For the city of Korça, in the Gas Master Plan, it is foreseen that its gas supply shall be made directly from the PRMS, which are planned as future additions to the above-ground facilities of the TAP as foreseen in the National Sectoral Plan for the TAP project and EIA for TAP in Albania. Together with PRMS Fier and Kuçove, these are the three exit points of TAP. Referring to the Gas Master Plan - Section 24: CP3 Korçë - PRMS Pogradec, This section is about 35.3 km long and mostly passes through the Korçë field.

In the wake of the innovative gasification project of Korça, which shall bring multi-faceted benefits to the city and the community, where Albgaz held a consultative meeting with actors and stakeholders including representatives of local businesses, civil society and industry with the aim of coordinating towards the fulfillment of this ambitious objective. Representatives of SOCAR, the Azeri leader in

the field of oil and gas, who as strategic partners of Albgaz bring the necessary expertise and support for the implementation of this first-of-its-kind project, in accordance with the highest international standards, were also present at the meeting. The optimal progress of the realization of this project and the optimism with which it has been received by the interest groups and the community testify to the will of the Albanian government towards the prioritization of long-term solutions that guarantee energy security and sustainable development that simultaneously measures the reduction of the impact on the environment.

6.11 Objectives for the Future in the Natural Gas Sector

Cooperation with the Energy Regulatory Authorities of neighboring countries, Greece and Italy, as two EU member states, for the normal operation of TAP. Updating all by-laws, in accordance with the regulations and taking the joint decisions necessary for them, in accordance with Directive 2009/EU and Regulation 715/EU, Commission Regulation (EU) 2017/459 (CAM NC) and a number of other regulations related to transparency, discrimination of third parties and joint decision-making for this purpose.

Cooperation with TAP AG and the Regulatory Authorities of Italy and Greece for the successful completion of the Market Testing that began in 2021 and continues throughout 2022 for the expansion of capacity from 10 billion m³/year to 20 billion m³/year. This testing is harmonized with the provisions of the Final Joint Opinion of the Energy Regulators on the Application for the Exemption of TAP AG, dated 6 June 2013, issued by the Authorities under Directive 2009/73/EC, ('Final Joint Opinion') of TAP Tariff Code6 with EU Regulation 2017/459 creating the network code on Capacity Allocation Mechanisms for gas transport systems ("CAM NC").

Cooperation with the Energy Community Secretariat for the transposition of the changes being carried out in Directive 2009/EU and Regulation 715/EU as well as other acts related to the sector of natural gas, biogas, biomethane, hydrogen, the use of liquefied gas with small scale, the use of compressed methane gas (CNG), etc.

Cooperation with the Ministry of Lines (MEI) for the gas transmission and distribution network in Albania as well as the possibility of capacity reservation in Fier and in Kuçovo, Roskovec planned for entry and exit points.

Cooperation with MEI and Albgaz for the construction of the Fier-Vlora pipeline, the connection with the TAP pipeline and the possible terminal that shall be built by Exxelarete. This shall also serve for the introduction of methane gas into the pipeline network of TAP and IAP.

Cooperation with MEI and Albgaz for the construction of the IAP pipeline (Ionian Adriatic Pipeline) from the point of contact with TAP in Fier to Croatia:

The Ionian-Adriatic pipeline, which shall be connected to TAP at the connecting node in Fier, shall cross about 170 km in the Albanian territory, to continue further north through Montenegro, Bosnia-Herzegovina and to end in Croatia where it connects to the Croatian transmission system, Plinacro. The capacity shall be designed to transmit up to 5 bcm. The technical parameters are: 32" (pole) for the diameter, 75-85 bar.

The implementation project has been completed, the start of its construction is expected. This shall make our entire region; Albania, Montenegro, Kosovo, Bosnia-Herzegovina, which currently do not have a developed gas market, to integrate into this network.

Cooperation with MIE and Albgaz for the IAP Section: Kashar-Montenegro. This section covers a length of about 86 km, from Kashari to the border point with Montenegro. The expected value of the investment is EUR 165 million. The Feasibility Study has been carried out, while in the time frame during the years 2025 to 2026, Pre-FEED and FEED are expected to be carried out, to conclude with the commissioning of the asset in 2030.

Cooperation between MIE and Albgaz for Dumrea underground natural gas storage. Another important project related to the gas infrastructure is the construction of a natural gas storage site in the area of Dumrea, which is planned to be realized in two phases, based on the cooperation between Albgaz company and SNAM, which is expected to start with the creation of a structure divided into two storage sites with a combined capacity of 230 m³/h of gas, while the second phase foresees the expansion of this structure up to the capacity of 800 m³/h of gas, giving this a regional dimension.

Cooperation with the Ministry of Infrastructure and Energy and Albgaz company for Cooperation and Handover Agreement on the Fier South Facility. TAP shall design, procure and build the gas exit point in Fier, an investment of several million Euros in the country, this shall enable the supply with gas to the customers of our country through this point.

Cooperation with MIE and Albgaz for the Market Testing period of 2021, 2022 and beyond, after the non-binding expression of interest phase, TAP has received interest requests for capacity and connections in Albania for; the interconnection point in Kuçovë, for the interconnection point in Fier and the Roskovec exit point.

Also cooperation with MIE and Albgaz for the following non-binding requests for connection points: an exit point in Relievi Roskovec, an exit point in Kuçovo and two (2) requests for connection points in Fier. Developments at these exit points shall depend on coordination between TAP and the requesting party. MIE is decisive in granting the right according to the energy policies it has. (This information is made available to the public in the Demand Assessment Report published by TAP on October 25, 2021 and the next report throughout 2022).

Cooperation with the Ministry of Lines (MIE) for the amendment of law no. 102/2015 "On Natural Gas Sector", as amended, to meet the conditions of certification of the Natural Gas Transmission Operator, Albgaz company.

6.12 Relations with International Institutions in the field of Natural Gas

CEER (Council of European Energy Regulators) - where ERE is an observer as a candidate country for the European Union and has its contribution as a participant in working groups for legal amendments, improvement of directives and regulations in the gas sector, for the long-term preservation of energy in crisis conditions, the amendment of the energy efficiency directive, the customer, the photovoltaic energy strategy.

ACER (Agency for the Cooperation of Energy Regulators) Agency for Cooperation of Energy Regulators for Europe). ERE is a member with full rights and at the same time a participant in the working groups for: investments, volatility and energy prices, priority for the customer, retail supply and treatment of market volatility, the document for small-scale LNG service, etc.

⁶ Approved in November 2013 by the Italian, Greek and Albanian Regulatory Authorities. An amendment was also approved in July 2018

GRI SSE, SOUTH SOUTH-EAST GAS REGIONAL INITIATIVE Participation in working groups for: wholesale gas market, retail market, implementation of the network code, congestion, tariffs in the transmission, distribution and border networks, 10-year development plans, etc.

MEDREG, Natural Gas Working Group, Association of Energy and Natural Gas Regulators for the Mediterranean region. The participation of ERE in regional studies such as: the infrastructure of the Mediterranean region, the integration of the Mediterranean infrastructure with the European one, retail and wholesale prices, cooperation with ECRB studies in Vienna.

ENTSO-G (Observer in the European Network of Transmission System Operators for Gas). Our participation in working groups for joint studies

IGU (International Gas Union). Active participant through working groups.

OME OME (Mediterranean Observatory for Energy) located in France, where ERE is a member with full rights and a participant in regional studies conducted by it.

UfM (Union for the Mediterranean region) ERE is a member with full rights and an active participant. In the working groups organized for the problems of natural gas part of OME located in Paris.

ECRB, Gas Working Group, the Energy Community Regulatory Board participation in their studies and the possibility of attracting foreign investments for the development of infrastructure in our country.

7. ON ERE REPORTING, REGARDING THE IMPLEMENTATION AND FOLLOW-UP TO COMPLETE THE RECOMMENDATIONS OF THE “ALBANIAN PARLIAMENT RESOLUTION TO ACCESS THE ACTIVITY OF ENERGY REGULATORY AUTHORITY FOR 2021

The Assembly of Albania on 28.04.2022, approved the Resolution "On the evaluation of the activity of the Energy Regulatory Authority for 2021".

Based on letter "b" of point 1 of Chapter 2 of the "Annual and periodic monitoring guideline" approved by decision no. 134/2018 of the Assembly of Albania as well as the Resolution of the Assembly of Albania for the assessment of the activity of the Energy Regulatory Authority for 2021, below is presented relevant information on the work carried out by ERE on the level of implementation of the recommendations of Assembly, detailing the measures taken, draft acts in process or approved acts and decision-making, detailed in relation to each point of the resolution throughout 2022.

The Assembly of Albania with official letter Protocol no. 1244/2 dated 05.05.2022, submitted at ERE the "Resolution of the Albanian Assembly for assessing the activity of Energy Regulatory Authority for 2022". In accordance with decision no. 134/2018 of the Assembly of Albania "On the approval of the Annual and periodic monitoring guideline" below it is provided a copy of the information related to the implementation of the tasks of the resolution of the Assembly by the Energy Regulatory Authority.

With decision no. 155 dated 13.06.2022 ERE has approved the plan of measures for the implementation and follow-up of the recommendations of the Assembly's resolution.

As for the requirements of the Assembly of Albania for ERE during 2022, in summary it is clarified that these tasks are related to the establishment of periodic correspondences with the institutions of responsibility or with the licensees in order to fulfill the tasks. The strategic planning of monitoring in order to supervise the fulfillment of the tasks left to the licensees and charged by the legislation in force and to address issues of interest to the customer in terms of maintaining a quality service to them, both by the licensees and by ERE.

ERE in cooperation with MIE (Ministry of Infrastructure and Energy) and other actors in the field of energy shall play an active role in the design of a concrete plan, to make it possible to ease barriers, promote and incentivize self-production plants of energy from renewable sources (especially solar and wind) both for large generating businesses, which have a higher energy consumption, and for households. Investing in plants for the self-production of energy from renewable sources, taking into account the situation and the latest developments in the global energy market, affects on the one hand the reduction of energy costs for generating businesses and households, and on the other hand, the reduction of energy consumption from the grid and the diversification of energy production.

Given that currently the law on renewable resources has been published for consultation by the Ministry of Infrastructure and Energy, ERE shall engage in the issuance of regulatory acts that emerge as an obligation of this law after its approval in the Assembly.

ERE has requested information from commercial subjects, regarding the degree of interest shown during 2022 by electricity customers for the installation of photovoltaic panels for the category of household and non-household customers, as well as an assessment from the trading subjects regarding the rate of return of the investment made for these plants.

The subjects that have supported with information this request of ERE have informed that the plants handled are non-household customers, mainly light industry, textile and heavy industry. It turns out that for the period March 2021-March 2022 the market for photovoltaic systems has had a significant increase. One of the factors that gave impetus to this sector was the increase in electricity prices in the stock market. The collected data have reflected that the installed plants had a MAX capacity of over 3.5 MWP and 5 MWP.

In cooperation with all the actors in this field, it shall give its contribution and technical expertise, starting from the high energy prices and the latest developments in the global energy market, to make it possible to strengthen the support mechanisms for vulnerable customers as well as maintaining the balance between the interests of customers, the state and entrepreneurs.

Based on the measures provided in the Calendar of measures approved by ERE Board for the implementation of the tasks of the resolution, through the working group established for this purpose, the study of the best regulatory practices for addressing support for the category of vulnerable customers and issuing the most applicable scenarios as well as drafting a regulation for determining the criteria for obtaining the status of vulnerable customer. The work of the Group set up for "Study of best regulatory practices for addressing support for the category of customers in need and deriving the most applicable scenarios" is still in progress. Regarding the drafting of the conditions for determining the criteria for receiving the status of the vulnerable customer, the task imposed is based on tLaw no. 43/2015 On Power Sector as amended, where in article 95 point 1 it is determined that:

"The ministry responsible for social issues, in cooperation with the ministry responsible for energy, the Ministry of Finance, and in consultation with ERE and interest groups, drafts the criteria, procedures for the benefit of the vulnerable customer's status and the manner of their treatment, which are approved by decision of the Council of Ministers.

However, through correspondence, ERE has requested information from the Ministry of Social Welfare and Youth on the average number of families that have been in the support scheme during the calendar year 2021, as well as requested further information from MIE, MFE, MSH and MS as well as DSO company regarding the progress of the work in order to draft the regulation on the specific criteria and procedures to obtain the status of vulnerable customer provided for in the legislation in force. It turns out that the inter-institutional working group set up for this purpose is in the process of drafting this document, and ERE intends to give its contribution, based on the results of the study that are intended to be published after the completion of the study for this purpose.

ERE has approved the Regulation on specific conditions for the interruption of the electricity supply for vulnerable customers, as an obligation of the law of the power sector for ERE, and fulfilled on time. In terms of the obligations arising from the licensee FSHU company, from this regulation, the correspondence continued with FSHU company to remind the tasks left by ERE on the implementation of the provisions of this regulatory act where, among other things, it is emphasized the creation and maintenance of a register with the number of vulnerable customers in the form of comparative and statistical data, as well as the procedures followed for deregistration of these customers beyond the identification of complaints from this category, etc. This task left in the calendar of the resolution is partially fulfilled, as it is in process.

The following cooperation between ERE and MIE for the design of the Methodology for determining the purchase price of electricity produced by self-producers as well as to play a proactive role and cooperate with all actors to solve various problems arising from the installation of small renewables resources such as the problem of the way of handling netting by DSO company etc.

This issue is clarified in point 2 above.

ERE requests maximum commitment from all actors to make it possible for the operation of the power market to be functional within 2022. The operation of the power exchange has a direct impact on the integration of the electricity market between Albania and Kosovo, as well as on facilitating the integration with other markets of neighboring countries in accordance with the EU electricity market regulations and the targeted European Model,

ERE has continued the work on identifying and analyzing the legal and by-legal framework of Albania and Kosovo, which regulates the activity of the Albanian Power Exchange - ALPEX company. It can be mentioned with certainty and pride that inter-institutional communications have increased significantly with the aim of improving the legal framework and harmonizing the work of the Energy Regulatory Authority and the Energy Regulatory Office, which was finalized in December 2022 with the collegial signing of the rules of operation of the power exchange market by ERE and the regulator of Kosovo. During 2022, ERE has finalized the licensing procedure of the "Albanian Power Exchange - ALPEX" company in the electricity market operation.

Based on articles 16; 18, point 1, letters "a" and "dh"; article 19 letter "a", articles 57 and 98 of law no. 43/2015, "On power sector", as amended, Council of Ministers Decision no. 519, dated 13.07.2016 "On the approval of the electricity market model" as well as the "Regulation on ERE organization,

operation and procedures ", approved with decision no. 96, dated 17.06.2016, ERE in the joint meeting with the Regulator of Kosovo on 27.12.2022, through decision no. 347, dated 27.12.2022 approved the electricity market rules (ALPEX rules, definitions, trading procedure as well as Clearing and Settlement procedure).

In this same prism, it is working with the assistance of USAID to coordinate the work between the regulators, TSOs and the power exchange to enable the unification of the markets between Albania and Kosovo and further with North Macedonia or Montenegro.

ERE shall continue the support with technical expertise to make possible the construction of the natural gas transmission and distribution network as a project of importance for the country in terms of increasing energy production and diversifying production sources and make concrete proposals in function of the new opportunities created for the development and exploitation of the gas market. The commissioning of the TAP gas pipeline should be seen as a priority by ERE as an opportunity that makes the construction of this network even more necessary for increasing energy production through the use of gas.

ERE has preceded the adoption of several by-laws which have influenced both the possibility of building the transmission and distribution networks. In addition, the necessary by-laws for the LNG Terminal (Liquefied Methane Gas) have been approved, as well as other acts for the underground storage of natural gas, in the salt of Dumre area, specifically:

Methodology for calculating the tariff for the regasification service of the lng system operator

Rules of operation of Liquefied Natural Gas (LNG) terminal

License for the Operation Activity in Natural Gas Storage Facilities

Metodologjinë e llogaritjes së tarifës për ruajtjen nëntokësore të gazit në Kripërat e Dumresë The methodology for calculating the tariff for underground gas storage in the Salts of Dumre Regulation for underground gas storage in Dumre

License for underground gas storage in Dumre.

Energy Regulatory Authority is cooperating with Albgaz company for the construction of the 30" pipeline from the Terminal in Vlora to the meeting point with TAP in Topoja, Fier. It is believed that this shall create the possibility of speeding up the repair of the Vlora TPP and putting it into operation. The pipeline with a length of 30 km from Vlora to Fier shall create the possibility that, in addition to our needs, gas can also be injected into the TAP network for the needs of the Region.

The cooperation is also continuing for the acts that enable the construction of the IAP (Ionian Adriatic Pipeline) gas pipeline.

At the same time, ERE is cooperating with the Regulatory Authority of Italy and Greece for the improvement of TAP by-laws such as: TAP Network Code, Market Test for 2022 that shall continue for 2023, which shall increase the transport capacity of gas from 10 billion m³gas to a larger amount.

For 2022, it is foreseen that TAP shall transport about 12 billion m³ of gas/year. This creates the opportunity for our country to have available sufficient amounts of gas through the points in Fier and Kuçovo.

On the official website of ERE, the link/graphic "Make a complaint" shall be placed and the green number available to citizens/customers shall be easily accessible.

In this regard, ERE, after applying to AKEP to obtain a toll-free number, has continued to promote it widely on the ERE website as well as other social networks.

Likewise, the **"Make a complaint"** link/graphic has been created and is clickable, taking the customer directly to the complaint form, to the page in the Albanian version and the one in the English language version, helping to improve the promotion of customer service contacts. In addition to the above, during 2022, ERE has also activated a toll-free telephone number, through which requests for customer information are addressed in real time, as well as guidelines are given for the fastest addressing of complaints according to the area of responsibility and legislation in force

This task appointed in the calendar of the resolution is fulfilled.

The implementation of the "Regulation on the measures of the licensees in electricity supply activity for the achievement of the indicators prepared by ERE for measuring and evaluating the performance of customer service, and is regarded as an important step in providing a quality service with standards for the customer.

For this purpose, ERE through decision no. 23 dated 14.02.2022 approved the Regulation on the measures of the licensees in electricity supply activity for the achievement of the indicators prepared by ERE for measuring and evaluating the performance of customer service. This decision entered into force on 01.06.2022 and the effects for the purposes of the first reporting include June 1 - December 31, 2022 period.

In the above-mentioned regulation, the responsibilities of the suppliers are determined in terms of the measures they must take in order to achieve measurable performance indicators of customer service. Regardless of the above, ERE has maintained correspondence with the licensees in order to obtain information from the latter regarding the measures taken in order to meet the conditions of the obligations that arise on time, which shall therefore qualitatively affect the increasing customer service.

It shall be mentioned the establishment of obligations for the creation of customer reception centers, the establishment of a telephone number, the establishment of special structures for the handling of complaints or the provision of conditions for the access of persons with disabilities to the premises of suppliers who offer this service, whether in conditions of the universal supply service but also those in the free market.

The licensees have periodically reported on the measures taken to implement in advance the tasks that this regulation issues for the licensees in the supply activity.

This task required in the calendar of the resolution is fulfilled.

The follow-up by ERE of monitoring related to customer protection issues and the implementation of the tasks arising for FSHU company

In relation to this task, it results that during 2022 the following monitorings were planned and carried out:

Monitoring on ensuring the access of third parties in accordance with the requirements of the Law and acts approved by ERE. The deadlines within which TSO company makes the new connection.

Monitoring in FSHU company on deadlines and procedures for handling customer complaints.

Monitorim në OSSH sh.a. lidhur me mbikqyrjen e standardeve të arritura të cilësisë së shërbimit të furnizimit dhe performancës së rrjetit të shpërndarjes së energjisë elektrike për periudhën janar 2021-mars 2022.

Monitoring in TSO company regarding the supervision of the achieved standards of quality of supply and safety performance of the electricity transmission network for January 2021- March 2022 period.

Monitoring in FSHU company regarding the obligations and periodic reports as well as on the supervision of the implementation of the duties arising for the licensee from ERE Board decision no. 201/2018, reviewed with the decision no. 217/2020 on reviewing the "Plan of measures for the Electricity Distribution Operator OSHEE company., for respecting the rights of electricity supply customers", Approved with ERE board decision, No. 201, dated 03.09.2018.

ERE, in cooperation with the Efficiency Agency and referring to the best international practices, shall work to sensitize the customer on the efficient use of electricity, which translates into energy savings and lower costs for the customer.

The measures taken for the implementation of the above include bilateral meetings with the Agency for the discussion of common practices and the establishment of a common mid-term strategy for addressing issues of customer interest regarding the efficient use of energy.

Regarding this task, ERE has continued with correspondence and meetings between the representatives of the Energy Efficiency Agency, with the aim of running joint promotional campaigns related to customer awareness regarding the efficient use of energy. ERE has requested from FSHU company that the electricity consumption bill includes the link or QR code that generates the informative brochures prepared in cooperation between ERE and the efficiency agency in order to familiarize the customer with the measures to be taken to save energy.

Despite the above, during the last few months, facing the severe energy crisis that has affected the region and Albania, ERE has undertaken a series of awareness campaigns for increasing the efficiency of use and reducing the consumption of electricity, which have been published in ERE's official website under the voice "customer services", but also on social networks.

FSHU company has responded expressing the will and agreement for the increase of cooperation. ERE and the Energy Efficiency Agency, during 2023 shall continue the cooperation with FSHU company on the application modalities of this cooperation, conceptualizing it as an innovation that provides updated information on the electricity bill that guarantees wide access to all customers.

To take the necessary measures for the realization and implementation of the platform through which the licensees in the supply activity who shall exercise this supply activity of customers in the free market, shall be able to provide data in real time regarding the price offered for electricity supply in the free market

In the 2022 budget, the fund for the purchase of software for the realization and implementation of the platform through which the licensees in the supply activity who exercise the activity of supply to customers in the free market is provided, and the procurement procedure is being developed with the aim of ensuring the respective platform which shall be in operation within 2023.

The possibility of the gradual installation of smart meters based on a cost-benefit analysis and of coverage with the telecommunications network as, among other things, it improves the quality of service to the customer, avoiding the problems of overbilling and customer

complaints.

In relation to this issue, the responsible structures of ERE have continued communication with DSO company requesting the latter to take measures to carry out a cost-benefit analysis for the gradual installation of smart meters in a larger number of customers especially taking into consideration that the installation of a secure metering system not only reduces the number of overbilling complaints and avoids problems related to metering, but also creates the opportunity for the non-household customer as well as the household customer to use the space that the law on the power sector has guaranteed them, to enter the liberalized market by evaluating the best offers.

Considering that with the approval of Council of Ministers Decision No. 584, dated 8.10.2021 "On declaring a state of emergency in the supply of electricity, amended by No. 256, dated 29.4.2022 for some amendments in Council of Ministers decision No. 584, dated 8.10.2021, "for announcing the state of emergency in the electricity supply", KESH company, TSO company and OSHEE company are obliged to make investments which are most necessary for the exercise of the activity and have to carry out the daily work to deal with the emergency situation and ensure the electricity supply of the situation.

However, ERE shall focus on the treatment in the future, with the end of the energy emergency situation, closely following the assessment of the possibility of the gradual installation of smart meters by the operator.

8. ERE ACTIVITY REGARDING THE DEVELOPMENT OF THE SECONDARY LEGISLATION AND OTHER LEGAL AMENDMENTS DURING 2022

The draft, review, and approval of the by-legal acts of the power and natural gas sector within their adoption with Law. 43/2015 “On Power Sector”, as amended, and Law no. 102/2015 “On Natural Gas Sector” as amended.

During 2022, the Energy Regulatory Authority (ERE) continued its work with the completion of the legal framework in the electricity and natural gas sectors, through the adoption of a significant number of acts that further enrich the secondary legislation.

Despite the energy crisis in 2022, ERE, through its decision-making, has influenced coping with a difficult situation faced by the energy sector. During this year, ERE board approved 360 decisions in 61 board meetings.

ERE Board decisions, also this year, had as their main object the revision or amendment of the acts approved earlier, the postponement of the deadlines defined in the decisions or acts, the extension of the decision-making deadlines of ERE Board, the opening of the procedure or the licensing / renewing the licenses of entities in the activities of electricity trading, production, supply or in the activities of natural gas trading, reviewing the applications of DSO company for the approval of the electricity distribution service tariff at the voltage level for 2021 and FSHU company for the approval of the price of the electricity retail service for 2021, the opening of the procedure to review the application of tariffs of the Distribution System Operator for 2022 and to review the application of TSO company for the electricity transmission tariff for 2022 and 2022-2024 period for which ERE also held an official public session, etc. Also, during this year, several disputes between licensees in the power and natural gas sector were resolved.

ERE Board decisions in the Power Sector for 2022

Decision no. 23, dated 14.02.2022 "On approving the regulation on the measures of the licensees in the supply activity for the achievement of the indicators for measuring and evaluating the performance of customer service"

Pursuant to law no. 43/2015, "On power sector", as amended, ERE has the right and duty to monitor, control and inspect the services of licensed operators in relation to compliance with legal obligations, as well as the implementation of ERE decisions and orders. In order to protect the interests of customers by enabling them to be treated equally and non-discriminatory through transparent legal procedures, ERE has approved the Regulation on the measures of the licensees in the supply activity for the achievement of the indicators for measuring and evaluating the performance of customer service. For the completion of this practice, the opinion of the involved parties was taken and all their opinions regarding this regulation were published on the official website of ERE in the consultation section.

Decision No. 45, dated 18.03.2022 "On approving some additions and amendments on tap network code, with the proposal of tap ag company, approved with ere board decision no. 97, of date 15.06.2020

TAP AG, with official letter dated 29.12.2021, after consultation with the users, has presented to the Authorities a proposal for some amendments to the Network Code presented in Annex A. The additions and amendments are related to functional additions to make more efficient the formalities necessary for obtaining and maintaining the status of "registered user", necessary to request the allocation of transport capacity; Introduction of provisions aimed at strengthening and making more efficient the safeguards to guarantee the exposure of TAP AG to users; Introduction of provisions allowing the management of a transport service in terms of volumes of gas injected upstream by defining a new virtual entry point that includes the physical points of Komotini and Nea Mesimvria.

Between 12.10.2021 and 11 November 2021, TAP undertook a public consultation for the review of the proposal for the amendment of the TAP Network Code. The amendments in the TAP Gas Pipeline Network Code are in line with the principles included in the relevant European legislation and the Final Joint Opinion as well as in line with the common reasoning with the other regulators involved in Greece (RAE) and Italy (ARERA), presented in Annex A of this provision.

Decision No.63 dated 11.04.2022 On reviewing the request of TSO company for the approval of the transmission code.

ERE Board with decision no. 160, dated 02.07.2021, decided to open the procedure to review the request of TSO company for the approval of the Transmission Code and with this decision decided on the approval of the Transmission Code.

Decision No.72, dated 13.04.2022 On approving the electricity transmission tariff for 2022-2024 period.

In cooperation with the TSO company ERE Board with decision no. 72, dated 13.04.2022 decided "On the approval of the electricity transmission tariff for 2022 – 2024 period. For this practice, the historical average of energy transmitted by TSO company for consumption, as well as the increasing gradient of energy demand of 1% were taken into consideration.

The value of electricity purchase cost is set based on the proposal of TSO company for each year of the regulatory period. As far as the revenues generated from the auxiliary services provided to KOSTT are concerned, they have been deducted from the calculations made during 2021 and the value of the auxiliary expenses for the next regulatory period has been calculated according to the actual realization of this expense for 2021. Also, weighted average cost of TSO company capital for 2022 – 2024 period is calculated at the level of 2.28%.

Decision No.73, dated 13.04.2022, On approving the electricity distribution service tariff in voltage level for 1 May- 31 December 2022 period.

Following the announcement of the state of emergency of electricity supply, DSO company submitted at ERE the request for updating the application of distribution tariffs for 2022. Pursuant to Council of Ministers decision no. 758, dated 09.12.2021, the target level of losses in the distribution network for 2022 is 19.6%. Based on this level, losses in absolute value due to the calculation of the distribution tariff for 2022, are considered 1,408,013 MWh.

In the framework of price trends in the international electricity markets, the price of purchasing electricity in the unregulated market to cover losses in the distribution network for 2022 is the one proposed by DSO company and the new tariffs are expected to be applied for May 1 - December 31, 2022 period, the correctable difference for January 1 - April 30, 2022 period, shall be reflected in the increase of the average distribution tariff for the remaining period of 2022, in order to recover the unbilled income in the first 4 months of the year and shall be corrected in the deduction in the following regulatory period.

Decision No.74, dated 13.04.2022, On ERE evaluation for the activity costs of the Universal Service Supplier for 01.05.2022 – 31.12.2022 period

As a result of the postponement of the legal force of ERE Board decision no. 214, dated 15.12.2020, with decision no. 252, dated 21.12.2021, ERE assessed the costs of the universal service supply activity by considering the transfer of the costs of electricity transmission and distribution activity, as well as the costs of purchasing electricity by calculating their effects on retail electricity sales prices of end-use customers served by FSHU company for 2022.

The estimated quantity to be sold by FSHU company to end-use customers connected at the 0.4 kV voltage level, is 4,613 GWh.

The administrative costs of the supply activity calculated for FSHU company for May 1 - December 31, 2022 period, were estimated about 1.06 ALL/kWh.

The General Assembly of KESH with decision no. 1349/1, dated 16.02.2022, "On the approval of the economic-financial program of KESH company for 2022, the 2023-2026 forecast", has decided, among other things, that the electricity sales price for customers served by FSHU company shall be 2.6 ALL/kWh.

Decision No.114, dated 19.05.2022, On approving the Regulation on the Protection, Processing, Storage and Security of Personal Data".

Pursuant to the legal obligations of law no. 9887, dated 10.03.2008, "On the protection of personal data", as amended, the Commissioner for the right to information and the protection of personal data, has published the standard Regulation for approval by public authorities with the aim of determining the organizational and technical procedures, measures for the protection of personal data and security, storage and administration of personal data by public authorities.

ERE Board, with decision no. 65, dated 26.03.2018, approved the "Regulation for the protection of confidential information". Pursuant to the obligations arising from law no. 9887, dated 10.03.2008 "On the protection of personal data", as amended, ERE has adapted the model Regulation drafted by the Commissioner for the right to information and the protection of personal data (the Commissioner), maintaining the terminology and technical-organizational rules for the processing of public, sensitive and secret information, as defined in the law and in the standard Regulation published by the Commissioner.

Decision no. 220, dated 01.09.2022 "On approving the amendments to the "Regulation on the procedures and terms for license issue, modification, transferring, renewal or license termination in the power sector".

ERE Board with decision no. 138, dated 07.06.2021, opened the procedure to review the "Regulation on the procedures and terms for license issue, modification, transferring, renewal or license termination in the power sector". ERE has addressed stakeholders for opinions on the proposed amendments. Regarding the amendments approved with ERE board decision no. 220, dated 01.09.2022, it has been estimated that applicants should submit at ERE only the documentation that is considered valid and sufficient for the granting/modification/renewal or transfer of a license and not documentation that was previously submitted in order to obtain approval /authorization or permits from the state authority/responsible body and the necessary relevant data can be found in these approvals or authorizations.

Also, a reconceptualization of the identification data of the subjects, declarations and technical data (depending on the type of application) has been made, and for the reasons of the application, special forms have been prepared, which are in the form of annexes and an integral part of the regulation, which are completed and signed by the applicant and submitted at ERE together with the other application documentation.

The revision of Annex A was evaluated and approved regarding payments according to the type of application.

Decision no. 230, dated 12.09.2022 "On approving the contract for the sale and purchase of electricity between KESH company and TSO company for covering losses in the transmission system for 02.07.2022 until 31.12.2022 period".

With this decision, the Contract has been approved, which has a total of 19 articles and 2 Annexes. Annex 1 of this contract presents the reconciliation report between the parties of the amount of electricity delivered by KESH company to TSO company on the specified date and time, as well as the signing by the representative parties of this contract.

Annex 2: presents the confirmation of the parties for the sale and purchase of electricity to cover losses in the transmission system, related to the delivery and receiving electricity. The references of this annex are: start of delivery, end of delivery, quantity delivered (MWh), sale price (ALL/MWh) and total value (ALL). The duration of this contract is for 02.07.2022 - 31.12.2022 period.

Decision no. 280, dated 01.11.2022 On approving the Harmonized Rules for the Allocation of the Interconnection Capacity for the Coordinated Auction Office in South East Europe (SEE CAO) for borders Albania - Greece, Albania - Montenegro and Albania – Kosovo

The Transmission System Operator (TSO) company addressed at ERE, submitting for approval the "Harmonized Rules for the Allocation of the Interconnection Capacity for the Coordinated Auction Office in South East Europe (SEE CAO) for borders Albania - Greece, Albania - Montenegro and

Albania – Kosovo, which shall enter into force immediately and shall become fully applicable starting from January 1, 2023".

The proposed amendments mainly consist of the following issues:

Introduction of dedicated business account;

Description of the triggering/ causative event in case of reduction;

Determination of (DAFD) deadline of the day in advance (according to Article 58 of EU HAR), DAFD to be published separately;

Compensation regimes in case of reduction (according to Article 59-61 of EU HAR);

Amendments in the settlement of bills (provided in Article 65 of the EU HAR) – amendments from the current version of the Specific Annex on the Borders of the Bidding Areas enabled by the EE CAO to the Harmonized Allocation Rules for Long-Term Transmission Rights", only in the extension of the deadline; Added a new article "Process and notification of reduction/termination in case of triggering event" (according to Article 5 7(3) of EU HAR).

Decision no. 324, dated 14.12.2022 On letting into force ERE board decision no. 73, dated 13.04.2022 "On approving the electricity distribution service tariffs according to voltage level, for May 1 - December 31, 2022 period"

DSO company has not submitted at ERE an application for the determination of electricity distribution tariffs for the following year based on the obligations according to the legislation in force.

ERE Board with this decision decided to postpone the legal force of ERE Board decision no. 73, dated 13.04.2022, until the approval of a decision based on the application of DSO company for 2023 or ascertaining the change of costs based on the legal and by-laws in force.

The situation of declaring the state of emergency of electricity supply covers only the first 6 months of 2023, based on the provisions of Council of Ministers Decision no. 584/2021, amended and the company during the remaining period of the following year may face the fact of purchasing the amount of electricity in the unregulated market in order to cover the losses of the distribution network at the time when the prices are expected to remain higher compared to the purchase price of electricity from priority producers;

With the end of the state of emergency of electricity supply on June 30, 2023, it also ends the imposition of the public service obligation on priority producers of electricity, who have a contract with "Free Market Supplier" company for the sale of electricity to the "Free Market Supplier" company, in accordance with the Electricity Distribution Service Tariffs according to the voltage level, for May 1 - December 31, 2022 period determined by the Energy Regulatory Authority;

It is estimated that if ERE finds a difference in costs, in accordance with the requirements of the legal and by-laws in force, the correctable difference shall have to be left as a reserve to the company, in order to cover the unforeseen costs of electricity to cover the losses of the distribution network throughout 2023 as well as the recovery of the negative capital accumulated over the years.

Decision no. 325, dated 14.12.2022 On letting into force ERE Board decision no. 74, dated 13.04.2022 "On approving electricity distribution service tariffs according to voltage level, for 01.05.2022 - 31.12.2022 period"

Decision no. 325 dated 14.12.2022 On letting into force ERE Board decision no. 74, dated 13.04.2022 "On approving electricity distribution service tariffs according to voltage level, for 01.05.2022 - 31.12.2022 period"

Council of Ministers through Decision no. 584, dated 08.10.2021, amended by Council of Ministers Decision no. 256, dated 29.04.2022 and Council of Ministers Decision no. 650, dated 10.10.2022, decided to announce the state of emergency of electricity supply, which extends its effects until June 30, 2023.

ERE Board with decision no. 74, dated 13.04.2022, has decided that the retail prices of electricity for 1 May - 31 December 2022 period are those approved with ERE board decision no. 252, dated 21.12.2021 and that customers who have met the legal and/or technical conditions for entering the liberalized electricity market are not subject to the provisions of point 1 of ERE board decision no. 74, dated 13.04.2022.

ERE Board with this decision decided to postpone the legal force of ERE Board decision no. 74, dated 13.04.2022, until the approval of a decision based on the application of FSHU company for 2023, for retail prices for end-use customers served by the Universal Service Supplier or ascertainment of the change of costs based on the legal and by-laws in force.

Decision no. 327, dated 14.12.2022 On approving the annual electricity purchase price to be paid to existing priority producers for 2023

ERE Board, with decision no. 13 dated 16.02.2016 decided that the fixed tariff for electricity, which shall be paid to producers of electricity from hydropower plants for 2016, shall be 7,448 ALL/kW.

The maximum price allowed based on the provisions of Council of Ministers Decision no. 687, dated 22.11.2017, as amended, is 15% higher than the price approved by ERE for 2016 for these producers: $7.448 * (1 + 15\%) = 8.5652$ ALL/kWh.

The purchase price, which results according to preliminary data, for 2023, is above the maximum limit (ceiling), i.e. 15% higher than the price set by ERE for 2016.

Based on the 11-month publications of the HUPX Dam Report, no such amendments are foreseen in the average price of the Hungarian Power Exchange as to affect the reduction of the upper limit of the purchase price of energy from these producers for 2023.

Regarding all of the above, the annual electricity purchase price that shall be paid to priority producers for 2023 turns out to be the price of 8.5652 ALL/kWh that is determined in the maximum limit of Council of Ministers Decision no. 687 dated 22.11.2017. This price shall be subject to revision by ERE in case of changes in its constituent elements

Decision no. 337, dated 21.12.2022 On approving the contract between KESH company and Free Market Supplier (FTL) company for the sale/buy/storage/exchange of electricity

ERE Board with decision no. 273, dated 27.10.2022, decided that: KESH company and FTL company to review the contract submitted at ERE, the legal basis and Article 8 of the contract between the KESH company and FTL company for the time period 01/01/2022- 31/12/202.

ERE Board with this decision decided to approve the contract between KESH company and FTL
Blv. "Bajram Curri", Rruga "Viktor Eftimiu" 1023, Tiranë
www.ere.gov.al

company for the sale/purchase/storage/exchange of electricity.

Decision no. 338, dated 21.12.2022 On approving the "Standard contract for the sale- purchase of electricity between the electricity production company charged with the public service obligation, whose shares are fully or partially controlled by the state, KESH company and Universal Service Supplier (FSHU) company for the supply of customers who are supplied by FSHU company

Through this decision, ERE Board decided to approve the standard contract for the sale- purchase of electricity between the electricity production company charged with the public service obligation, whose shares are fully or partially controlled by the state, KESH company and Universal Service Supplier (FSHU) company for the supply of customers who are supplied by FSHU company

Decision no. 347, dated 27.12.2022 On approving the electricity market rules (ALPEX rules, definitions, trading procedure as well as the procedure of settling and repayment)

With decision no. 272, dated 27.10.2022, ERE board decided "To open the procedure for approving the electricity market rules (ALPEX rules, definitions, trading procedure as well as the procedure of settling and repayment).

Currently, the operation of the electricity market is carried out through the Temporary Rules of the Albanian Electricity Market, approved with ERE Board decision no. 139, dated 15.08.2016. These rules themselves, at the moment of approval, are conceived as temporary and do not represent the current stage of market development.

With the start of the operation of the Albanian Power Exchange - ALPEX company and the transition to "go-live", the Temporary Rules of the Albanian Electricity Market, approved with ERE Board decision no.139/2016. If during the dry-run period it shall be deemed necessary by the Albanian Power Exchange - ALPEX company or TSO company to make changes or adapt the elements related to the aforementioned decision, they must be addressed at ERE for the relevant evaluations.

Legal processes on which ERE has been a party during 2021

Throughout 2022, the Energy Regulatory Authority has been a party called to court in court cases that have been initiated, continue or have ended. The court cases in which ERE has been called in the quality of the defendant, are 10 cases initiated in 2022 and 9 carried over from other years, in total 19 court cases. Court cases in which ERE has been called as a third party are 7 such initiated during 2022 and 11 carried over from other years, in total 18 court processes. As for court cases in which ERE is in the quality of the Plaintiff, in total there are 14 such cases. Within the framework of the implementation and fulfillment of obligations and responsibilities arising from laws no. 43/2015, "On Power Sector", as amended and no. 102/2015 "On Natural Gas Sector", as as amended, ERE has always been represented in a dignified and professional manner by its qualified staff.

ERE as a defendant party in court processes

ERE, in the quality of the defendant, has been called in 19 court processes, where mainly ERE decisions have been appealed, of which, it is worth noting that in the court processes with the plaintiff, the Albanian Renewable Energy Association "AREA", where the object of judgment is, "Declaration of invalidity of ERE Board decision no. 156. dated 24.12.2015 "On letting into force decision no. 139, no. 140, no. 141, no. 145, no. 146, no. 147. no. 148 dated 26.12.2014 as well as decision no. 27, dated 16.02.2015 of the Board of Commissioners of ERE for 1 January - 30 June 2016 period. Obligation of the defendant to issue a new act that shall regulate the consequences of the invalidity

of decision no. 156, dated 24.12.2015, through the correct determination of the fixed electricity tariff, according to the provisions of articles 15 of the law no. 138/2013 "On renewable sources of electricity", Administrative Court of Appeal, with decision no. 21, dated 26.05.2016, decided to dismiss the lawsuit of the plaintiff AREA. Against this decision, the claimant submitted an appeal to the Supreme Court, which with decision no. 00 - 2022 – 241 of Decision (38), dated 04.02.2022 decided to let into force decision no. 21, dated 26.05.2016 of the Tirana Administrative Court of Appeal, and

Also, in the judicial process with the plaintiff again, the Albanian Renewable Energy Association "AREA", with the object of judgment: Repeal the Energy Regulatory Authority Board decision no. 13, dated 16.02.2016 "On the fixed tariff of electricity from hydropower plants for 2016, published in the Official Gazette no. 33 of 2016 and decision no. 28, dated 09.03.2016 of the Energy Regulatory Authority, published in Official Gazette no. 43, of 2016, the Administrative Court of Appeal, with decision no. 28, dated 29.06.2016 has decided: "Dismissal of the claim of the plaintiff, the Albanian Renewable Energy Association (AREA), as not based on the law".

On 27.07.2016, the plaintiff Albanian Renewable Energy Association appealed against this decision to the Supreme Court and the Administrative College of the High Court with decision no. 00 – 2022 – 534 of Decision (124), dated 25.03.2022, decided to enforce decision no. 28, dated 29.06.2016 of the Administrative Court of Appeal.

Another judicial process that is worth mentioning is the process between the plaintiff "Albpetrol" company with object of judgment: 1. Repeal of the Administrative Act of ERE Board decision No. 178, dated 13.07.2022; 2. The permission of "Albpetrol company" as a licensed operator for the supply of electricity, the operation at the same price provided for in Article 6 of the Contract signed with "Anio Oil & Gas" company with No. 5208/alb dated 16.07.2018. (reference Anio Oil & Gas company No. 9/1 dated 16.07.2018; 3. Obligation of the defendant to pay court costs.

For this matter, the judicial investigation has been completed and the parties were given a few days to prepare and submit their final conclusions. It is expected that the court shall make a decision reflecting in a positive way the decision of ERE.

It turns out that, out of 19 processes where ERE was called to court as a defendant in relation to administrative decision-making acts, 3 of these processes were won, while the others are still in the trial process, the indicator of these cases is that ERE's decision-making is correct in accordance with legal and regulatory acts.

ERE in the quality of the third party

As for the processes where ERE has been summoned to court as a third party, there are a total of 18 processes, where the main subject of the trial are: Tax invoice invalidity; Damage compensation from Electricity Power Distribution System Operator (OSHEE) company: Taking the measure of suspending the implementation of the execution of the electricity sale bill; Invalidity of Executive title; Cancellation of Tax Invoices; Complaint by customers towards OSHEE company.

ERE in the quality of the Plaintiff

ERE, in the quality of the plaintiff party, has initiated 13 court processes, where 13 debtor companies have been sued. ERE, by decision of the board approves the adjustment payments for the licensed companies in the power sector which, based on point 52 of article 3 of Law no. 43/2015, have an obligation to pay on behalf of ERE. This decision is notified to the parties in writing and published in the Official Gazette. By order of ERE Chairman, the administrative investigation begins to take

administrative measures against the licensees who have not made the regulatory payment for the respective years, where the Working Group is established which would investigate to determine the state of facts and circumstances of each the debtor in order to take the necessary legal administrative or judicial measures, to minimize the damage caused, as well as collect the accumulated debts. This Order is also notified to the licensed subjects in writing and responses are expected from their part regarding the non-implementation of the regulatory payment decision. In the event that the subjects do not take measures to make the payment even after this notification, ERE board takes a decision to revoke the license for the subjects, which does not relieve the company of the obligation to make the regulatory payment. The legislation in force has provided for the right of ERE to take escalating administrative measures for the type of violation (non-payment of regulatory payments) from the imposition of a fine to the revocation of the license.

For all of the above, ERE has filed 13 lawsuits with the object of fulfilling the monetary obligation defined by law, as mentioned above, which are in the trial process by the Court of First Instance in Tirana.

9. ERE ACTIVITY REGARDING CUSTOMER PROTECTION AND STANDARDS SUPERVISION

Among ERE's main goals is to protect electricity customers by ensuring they are treated fairly and equally, ERE coordinates its work with government, industry and customer groups to provide the lowest cost to customers, eliminate bad practices and to ensure fair treatment for all customers, enabling competition and innovation that lowers prices and results in new products and services for customers. ERE intervenes with legal regulation where necessary to protect the interests of customers and conducts monitoring of the conduct of licensees when it suspects that they may have breached a condition of their licence, or customer protection requirements or legislation approved by ERE for this purpose.

An important part of ERE's work focuses on resolving electricity customer complaints by collecting and processing statistics on their number and nature. Especially in recent years, and more specifically during 2021-2022, ERE has taken a much more active role in terms of communication channels with customers that include physical appearance at ERE offices, addressing information on the status of complaints or information needed by the customer, through the toll-free number, submitting a written complaint, or even by email. In accordance with the legal framework in force, the Regulator undertakes the resolution of a complaint, after verifying that the submitted request meets the minimum criteria to be handled, and after ascertaining that the issue presented for consideration involves a licensed company. After analyzing the documentation made available by customers, ERE addresses the complaint to the licensee for obtaining the information and additional documentation necessary to resolve the complaint and allows it to process the data in order to generate a legal solution based on evidence and in law.

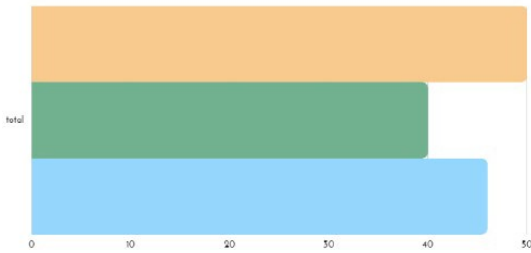

During 2022, it results that of the total number of 189 complaints/requests addressed at ERE, about 90 of them were addressed through electronic means of communication, ERE website, and the applicable form for filing a complaint. The above statistics establish an increasing trend of customer behavior by evaluating and applying this efficient and fast method of registering a complaint through electronic communication, thus creating a medium more easily accessible by customers in the districts.

Out of the total of 136 complaints registered in ERE, 50 of them were submitted via the form on the ERE website "make a complaint", another 40 via e-mail and 46 via traditional mail or ERE offices.

The graphic shows in yellow the complaints registered between the "make a complaint" form, in green the complaints registered by e-mail and in blue by mail.

Analyzing the graphic, it is evident according to the object of the complaint, the specific weight occupied by each category of the complaints that were addressed through ERE, for 2022 compared to the same categories of data recorded for 2021.

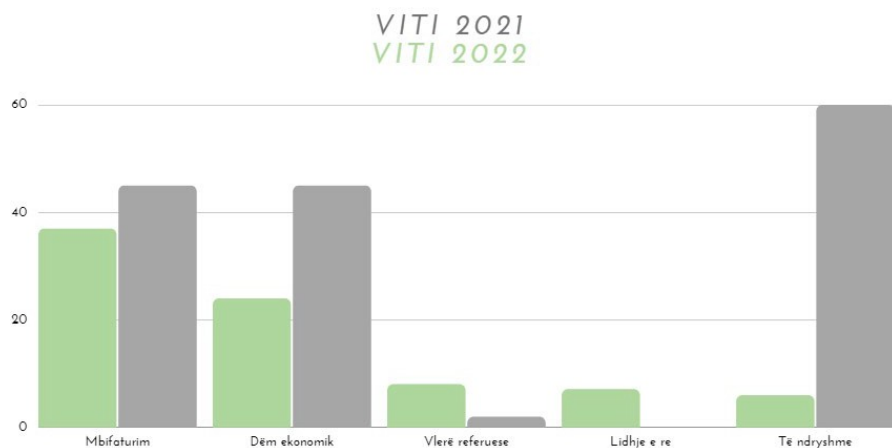

From the analysis of the data presented in the graphic, it is evident that for 2022 there is a decrease of small number of over-invoicing complaints, which in 2022 resulted in 37, compared to 2021, during which 45 such complaints were handled. Also, the number of complaints regarding economic damage during 2022 has suffered a decrease comparing it to that of 2021. During 2022, the number of complaints for economic damage turns out to be 24, while in 2021 this number resulted 45. During 2022, the number of complaints registered for invoicing with a reference value object has a slight increase, from 2 complaints for invoicing with a reference value that were registered in 2021, to 8 complaints registered in 2022, but only 1 of of them is related to the application of the reference value during 2022. During 2022, the registered complaints for new connection are 6, registering a very slight decrease compared to 2021, where the number of complaints addressed at ERE was 9.

9.1.1 Complaints for electricity over – invoicing

From the statistical data, it is established that the complaints with the object "electricity overinvoicing" account for a total of 37 complaints, or about 26% of the total complaints registered in ERE. These complaints are caused by various problems such as inaccuracy in the measurement data due to defects in the meter, the failure to reconcile the state entered in the system with the real state of the meter, etc. It turns out that out of the total of 37 complaints about electricity overinvoicing, 20 of them belong to the invoices issued during the 2007-2012, while 7 of them belong to 2020-2021, and 9 of them belong to 2022. Often sometimes customers present themselves to the responsible licensee or ERE, with a delay for the administrative strike of an invoice. The reasons for not accepting complaints are related to cases when customers are unaware of the issued invoice or when supporting documentation is missing from their side.

For all these complaints, ERE requests from FSHU company and DSO company the verification of the available practices and documentation related to the invoicing performed together with the recommendations for the relevant corrections that must be made in implementation of the established deadlines in the legislation in force, for this purpose according to the field of competence.

On the part of the licensees, measures have been taken to deal with 33 of the 37 complaints addressed by ERE with the object of electricity overinvoicing. It turns out that only for 21 of them, FSHU company after the verifications carried out, concluded that there was an inaccuracy in the calculation of consumption, and subsequently measures were taken for the accuracy/correction of the invoice, as well as the cancellation of some invoices and made the necessary corrections in the next month's invoice, as provided for in the legislation in force. It turns out that for 14 of these complaints by FSHU company no documentation was submitted, as the invoices are early and as a result, the documentation is missing. Also, some complaints have not been handled by FSHU company on the grounds that the legal deadlines for issuing an invoice have been exceeded as provided for in the legal framework in force. On the part of the licensees, it turns out that 2 complaints regarding the overinvoicing of electricity are in the process of being processed.

9.1.2 Complaint for Economic Damage.

Even during 2022, complaints were submitted at ERE regarding the opposition to the invoicing of economic damage by the responsible licensee, the Distribution System Operator. In the methodology on economic damage, the legal causes, circumstances and procedures for ascertaining and establishing the economic damage from illegal interventions in the distribution network which avoid the evidence of the real amount of electricity consumed by them by the users of the electricity distribution network are foreseen. DSO company is the operator responsible for ascertaining the economic damage caused to the distribution network by illegal interventions in this network.

ERE has handled 24 complaints with the object of economic damage or about 17% of the total complaints registered at ERE. It turns out, it turns out that 9 of them belong to 2011-2012, and 10 complaints for 2020-2021. There are only 5 registered complaints handled by ERE for the determination and placement of the economic damage during this year. For all these complaints, ERE addressed DSO company requesting information/documentation related to the act-stating of economic damage on their part, as well as the verification by the authorized subject of the circumstances in which the regulation foresees such an obligation.

From the total of 24 complaints handled by ERE, it turns out that 20 of these complaints were handled by DSO company. It turns out that 3 of the 24 complaints addressed to DSO company were rejected because they were submitted outside the legal deadlines for striking an invoice as provided for in the current legal framework. 9 of these complaints were found to be fair invoicing, and for 7 of these complaints, the finding of economic damage was not documented, due to the lack of documentation since the invoicing period is temporary and it is impossible to verify the supporting documentation in excess of legal period for keeping documentation, which is 5 years. It turns out that only for 1 complaint out of 24 complaints handled, DSO company after verification of the documentation and consulted information, in implementation of ERE recommendations, has taken measures for the invoicing system. From the above, for 4 of the complaints with this object, it results that the responsible licensee has not fully completed the documentation of the invoicing of the economic damage and therefore its verification.

9.1.3 Complaints about reference values

During 2022, it is established that 8 complaints with the object "reference value" were submitted at ERE, or about 5% of the registered complaints of 2021-2022. It is mainly about invoices with a reference value in cases where the measurement data were temporarily unavailable and inaccessible. It turns out that for 5 of these complaints, FSHU company has taken measures to systematize them after the inaccuracy has been ascertained and documented. For 3 of these complaints, FSHU company did not inform ERE and the complaining customer about the implementation of ERE's recommendations.

9.1.4 Complaints on Fictitious Contracts

During 2022, 7 complaints with the object of "fictitious contract" were registered in ERE, or about 5% of the total complaints registered in 2022, for the contracts opened for 2002-2012 period.

It turns out that customers only became aware of the existence of such fictitious contracts during 2021-2022. These old contracts, it turns out, do not have sufficient identification data to prove the legal relationship between the user and the service provider, unlike today, where at the moment of opening a contract, the personal data of the customers are recorded together with the identity card and the correct address. In addition, there are many individuals who, due to the identification of the contract only by name/surname, have the same identity and for this reason contracts are generated with the same name. Also, and due to the long time that has passed, it is impossible to recover either from the customer or from the responsible licensees the documentation on which the conclusion of the contract is based.

For these complaints, ERE has requested from FSHU company information and documentation as provided for in the legislation in force at the time of the contract. It turns out that for 5 of these complaints, FSHU company has provided an answer stating that it does not have documentation, while 2 of them, on the part of the responsible licensee, have not been handled according to the orders of ERE for documentation or verification of the collateral circumstances that can assist in identifying the customer's legal relationship with the contractor.

9.1.5 Complaints for new connection

During 2022 in ERE, 6 complaints were registered for new connections or about 4% of the total complaints registered in ERE. These complaints came as a result of not receiving a response or not approving the new connection by DSO company. It turns out that 2 complaints for which it was documented by DSO company that do not meet the conditions for a new connection, the customer's applications were rejected. It turns out that in 2 of the cases, after the handling of the complaint by ERE, and the fulfillment of the legal criteria by the customer, measures were taken by DSO company to approve the new connection. It turns out that 2 of them were not handled by the responsible licensee with documentation or review in response to ERE's request for handling the complaint.

9.1.6 Complaints on tariff change

In 2022, 5 complaints were registered in ERE for tariff changes, or about 4% of the total complaints registered in ERE. It turns out that for 4 of them, the tariff change was rejected by FSHU company due to the fact that the documentation presented by the customer was not complete. It turns out that only for 1 of them, measures were taken by FSHU company to change the tariffs. It is mainly about customers of the non-household category who, after changing their status to household, do not fulfill the legal provisions to document and apply to the supplier in order to change the applied tariff according to the category of tariffs approved by ERE.

9.1.7 Different complaints

In this group of complaints, complaints with the following objects are included: unmet energy, resettlement invoice, afrofe invoicing, electricity invoice, electricity interruption, under-invoicing, bad invoicing, meter crossing, consumption as a result of meter testing, complaints related to the generation of interest arrears, etc. In this group of complaints, about 48 complaints or about 55% of the total complaints registered in ERE are found. It turns out that for 35 of these complaints, FSHU company has informed that the customer has not met the legal criteria to avoid the cause for which he is complaining, which varies from not filing a request for contract suspension in cases of the application of the contract maintenance tariff, the lack of formal application of customers who intend to change the applicable electricity tariff. Other cases are those of customer complaints regarding the generated metering data, for which after verifications by the responsible operator, the correct operational state of the meter has been documented. Only 8 of the complaints in this category received a final solution, as it was assessed that they met the legal criteria. Five other complaints have not been addressed with documentation or information in response to ERE's request and are in the review process.

Pursuant to the complaint resolution procedures through the issuance of an order by ERE, as an obligation for execution by the licensee, in other circumstances as provided for in the Regulation for handling the complaints submitted by the customers and settling the disputes between the licensee, on power and natural gas sectors when the disagreement is repeated between the same customers, the regulation provides for a decision.

During 2022, after the above circumstances have been ascertained, ERE for 2 repeated customer complaints, issued a decision of the ERE board, resulting in the mandatory execution of ERE's findings.

During 2022, ERE has held 34 hearings sessions with the aim of resolving disputes between licensees in the Power and Natural Gas Sector, as well as handling complaints from energy customers. Hearing sessions initiated by ERE have been evaluated case by case as a good medium to obtain the necessary explanations regarding specific issues of complaints addressed to ERE, for which the insufficient documentary practice does not allow their final examination.

It is worth noting that, in the Regulation for the handling of complaints submitted by customers and for the resolution of disputes between licensees, in the power and natural gas sector, it is foreseen that ERE, as the case may be, shall submit the complaint for verification to the subject of appealed within 15 calendar days. From the analysis of the practices handled in ERE throughout this calendar year, it results that the average time of fulfillment of the above is about 11 calendar days. Also, on the other hand, the above-mentioned regulation foresees the obligation for responsible licensees to submit at ERE the requested information no later than 10 calendar days from the knowledge of ERE's requirements. It turns out that on the part of the responsible licensees, in some cases there was a delay in handling the requests of ERE or a correct misunderstanding of the requests for information or documentation.

Regarding the complaints registered in FSHU company from all sources, either directly at the customer care centers, from ERE, the co-governance platform, or through other institutions, ERE has requested information from FSHU company regarding not only the total number of these registered complaints but also the number of handled complaints as well as addressed customer requests throughout this calendar year.

From the data collected during 2022, it was found that the total number of complaints/requests submitted to FSHU company from all sources, is 139,713, of which only 30,085 turned out to be complaints registered with the supplier and addressed for resolution. The resolution level of these complaints is 97%, specifically resolved according to FSHU company there are 29,287 complaints.

Also, from the data submitted by FSHU company, it results that 109,628 are requests related to the exercise of duties in the supplier's area of responsibility, such as changes to contract data, requests for verification of meter data, etc., from of which 100,118 were handled.

The attached graphic shows the level of resolution.

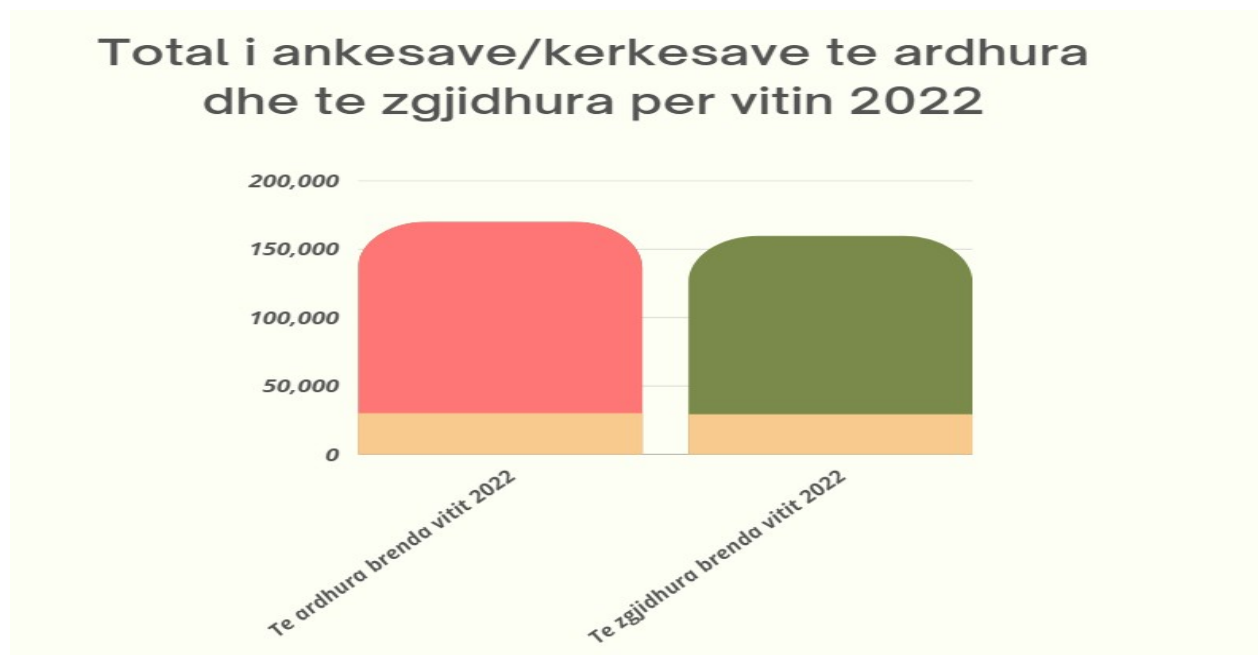

Figure 104 Complaints registered and settled

As for the data generated by FSHU company in relation to the specific weight of complaints registered from different sources, it results that from the total of 30,085 registered during 2022, 29,276 of these complaints were addressed by the physical units of the Customer Care Centers, 370 complaints from the Co-governance Platform, 159 Online complaints, 170 complaints from ERE (of which 136 are complaints from 2022 and the following communication differences for the resolution of complaints earlier) and 110 complaints addressed by the ombudsman.

According to the above statistics, it is evident that the largest weight is occupied by the complaints registered at the customer care centers with a total of 29,276 complaints.

The following graphic shows the weight of each source for addressing the complaint.

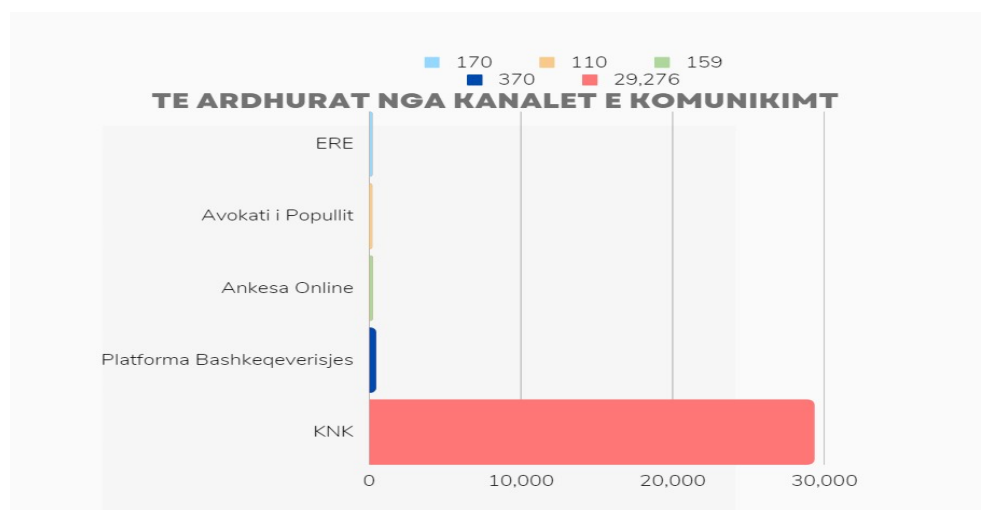

Figure 105 Complaints received according to communication channels

9.2 Giving Customers a Voice

Throughout this year, ERE has tried to be as close as possible to the customer, offering information in alternative ways to educate the latter on his rights, responsibilities and obligations. Through social networks, ERE has managed to distribute easily accessible information day by day, also in the form of a customer awareness campaign, giving advice on more efficient use of electricity. Furthermore, the distributed information has been in a utilitarian form related to important decision-making that affects the customer's interest as well as his familiarity with the legislation in force which regulates the relations between the parties. For the above, several informative brochures have been prepared and approved by the Board, which have been published on the official website of ERE www.ere.gov.al, as well as distributed on social networks such as Facebook, Instagram and LinkedIn. These brochures are also available physically in the premises of ERE. Some of these published brochures deal with the following information:

How to apply to benefit from electricity compensation?

Meter control.

What costs does the electricity invoice include?

Termination of the contract at the customer's request.

What shall the electricity invoice contain?

When shall the electricity be interrupted?

When can you complain at ERE?

The procedure to change the supplier.

The reading of the electricity meter is carried out by DSO company for a period of 30 calendar days.

How to reduce electricity consumption?

Call for applications to household consumers regarding solar heating panels for up to 2,000 (two thousand) household consumers.

In order to further fulfill this mission with the aim of giving a voice to the customer, ERE currently has a toll-free number which is active as it is provided for and implemented by the tasks left in the Calendar of the Resolution of the Assembly. This number serves as a communication bridge, free of charge, for the customer with ERE. The customer is familiar with this function and we have continuous communication via telephone as questions are addressed to us regarding the status of the submitted complaint, etc. Each customer is assisted regarding the status and further handling of his complaint, as well as provided with information for any ambiguity. They were also given guidance to follow the regularly updated complaint register on the ERE official website.



The toll-free telephone number established in function of the customer: 0800-23-23.

To be more accessible, this phone number is displayed not only on the official website of ERE and on social networks, but also in the official written communications addressed to the customer by ERE.

For ERE, customer feedback is also very important in order to improve and monitor the level of



information on the services offered during 2022. ERE is engaged in the creation of a column published on the official website <https://ere.gov.al/sq/>, under the Customer Services voice. The rubric provides detailed information for the customer and makes available to him the legislation in force and the complaint mechanisms available to the customer.

ERE work evaluation survey

In order to get a better assessment of the work it performs or can improve in its services, ERE has also organized a survey on the level of customer satisfaction. Customers have completed the survey, through which they have expressed their satisfaction and opinions regarding the services received or that they want to receive. Some of the survey questions are related to the services received at ERE and how complete was the information received on the official website of ERE. The survey is a right and not an obligation for the customer and from time to time it is distributed on the respective social networks as well as found on the website or enabled in the premises of ERE in cases of filing a complaint physically.

Recently, through social networks, a poll was organized on the official website of ERE, where various questions were published for the purpose of the above-mentioned aspects. Some of the questions generated in this survey are:

Which of the following choices do you currently supply? (The alternatives were FSHU company, FMF and Free Market Suppliers, where 91% of customers chose FSHU company) Where do you address/have you addressed the complaint about the electricity supplier? (In this question, 50% of the answers referred to the alternative "To ERE" compared to addressing the Supplier with 38% or the competent court with a result of 12%.)

Do you think that the legislation for the protection of customer rights is complete, complete but not implemented or do you have no knowledge? (25% of customers considered it complete, 50% complete and 25 % of them have no knowledge.)

How effective is the information you receive through the ERE website? (Based on the answer to the alternatives, mainly customers have rated it as "Very clear" and "Clear", with respectively 89% of the information they receive through the ERE website. Also, 11% of them have selected the alternative "Very unclear")

How satisfied are you with the service you received at ERE? (For the "Very Satisfied and Satisfied" alternatives, 85% of customers considered the service to be such, compared to 15% of those who remained dissatisfied.)

Communication between ERE and the main municipalities in the Republic of Albania, such as the cities of Tirana and Elbasan, has also continued. The meeting with the Municipality of Elbasan was organized with representatives of this institution as well as representatives of the relevant structures for the Alternative Dispute Resolution near them. In these meetings, the legal framework that regulates the power sector was presented, as well as the role of ERE in addressing customer issues. The Cooperation Agreements related to the universities consist in the organization and structuring of training activities as efficiently as possible, collaborating on a number of different projects which are made possible based on the intellectual competences of the Energy Regulatory Authority and are planned to be developed throughout the year after being agreed between the parties. Further aiming at the realization of the goals of these universities related to the improvement and enrichment of the content of the study programs and the commitment of the Energy Regulatory Authority to contribute in this direction through professional expertise in the power sector; as well as within the coordination of the theoretical content with the practical aspects for a more qualitative and professional preparation

of the students in cooperation. During the month of April 2022, the Albanian Customer Center has organized a series of presentation sessions regarding the role of various institutions in customer protection as well as the rights and obligations of the latter. In the meeting held on 07.05.2022, which was mainly related to customer rights, ERE representatives presented, among others, informational brochures as part of the information campaign, as well as the possibilities of access to customer information.

During 2022, the Albanian Customer Center has carried out the monitoring of central state institutions within the framework of customer protection through access to their official websites. The objective of the monitoring was the identification of information on the protection of customers and the level of its reflection by the responsible state institutions, among which the Energy Regulatory Authority is a part. In this monitoring, ERE has been positively evaluated regarding the evidence of information for customer protection, noting the section "Customer Services" and its good functioning. This section has been described as detailed for the customer and which puts at his disposal the legislation in force and the complaint mechanisms available to the customer. Furthermore, it has been identified that within the framework of customer protection, the Energy Regulatory Authority has created a subsection with the most frequent questions that customers may have and where the Authority's answers are available to them. In addition, due importance has been given to the facilitation of making complaints and contacting the ERE hotline by enabling automatic addressing in the relevant session of this service, which is easily found on the right side of the website.

9.3 Supervision of customer service of suppliers in the free market.

In order to supervise their activity as well as the fulfillment of customer service standards as well as the search for information regarding the reporting obligations that the licensees have, based on the acts that ERE has approved for this purpose, the Regulator has requested from the network operators, information on the current number of subjects licensed in the activity of active supply or who have concluded supply contracts by following the correspondence with 27 licensees in the activity of electricity supply related to this reporting, and result for 2022 about 19 who have returned answers of which only 12 are active and mostly there are no registered complaints. According to correspondence with TSO company and data collection, the latter reports that the suppliers that have exercised activity in the free market throughout this year, are 12 companies that have contracts for customer supply transactions.

Also, pursuant to law no. 43/2015 ERE, among other things, has the right and duty to monitor, control and inspect the services provided by licensed operators in relation to legal obligations as well as the implementation of the decisions and orders of the Regulator. ERE Board approved through decision no. 23, dated 14.02.2022 the Regulation on the measures of licensees in the supply activity to achieve the indicators of measurement and evaluation by ERE of the performance of customer service. This decision entered into force on 01.06.2022 and the effects for the purposes of the first reporting included June 1-December 31, 2022 period, and the legal effects started in January 2023. The aforementioned regulation defines the responsibilities of suppliers in terms of the measures that must take with the aim of achieving measurable indicators of performance towards customer service. It is distinguished the obligation of suppliers to provide information through telephone services, and any other form such as making available the web page, any Customer Care Center to provide information in addition to the service, as well as the preparation of forms/leaflets containing information on the service, supply or offers, measures aimed at facilitating disabled people's access to the services offered, etc. ERE attaches great importance to achieving and maintaining standards in order to provide

quality service to electricity customers and for this reason has requested preliminary information regarding the fulfillment of the anticipated obligations briefly described above, in addition to the regulation.

For all of the above, some of the licensees who have reported at ERE have presented the first draft of the Code of Complaints and Requests Management for their future customers and based on the latter, standard forms for complaints and various requests shall be prepared. It turns out that from what was requested, most of the licensees are in conditions in which they have not supplied any end-use customers during 2022, so in reference to the predictions of decision no. 23, dated 14.02.2022 "On approving the regulation on the measures of the licensees in the supply activity for the achievement of the indicators for measuring and evaluating the performance of customer service" article 8, point 1 where it is stated that: This regulation does not apply for suppliers who, during a calendar year, have not met the conditions of the reporting obligation. In any case, the suppliers who decide to exercise the activity of supply shall inform ERE of the measures taken to guarantee the fulfillment of the conditions of this regulation, no later than 15 days from the beginning of the exercise of the activity of supply to end-use customers.

9.4 Customers / Self-Producers

Law 7/2017 "On promoting the use of energy from renewable sources" integrated for the first time in 2017 the concept for self-producers of electricity. The purpose of this law is to promote the growth of energy production from renewable sources to ensure sustainable development in the Republic of Albania, in accordance with the obligations under the Energy Community Treaty. In accordance with the metering scheme, a small or medium-sized utility or a household customer can install a total capacity of up to 500 kW for the production of electricity from renewable sources such as wind or solar to cover part or all of the demand for the electricity necessary for its needs and to inject the excess energy produced into the grid.

As a task of ERE to monitor the performance of this relatively new market, a series of correspondences have been carried out in order to assess the impact that this category of producers has had on the country's gross production. For this purpose, the correspondence with DSO company has generated data which is monitored and analyzed periodically by ERE. During 2022, there were about 141 applications for household customers, who installed photovoltaic panels and make up 24.4% of the total number of new self-producing customers during this period. During 2022, there were about 438 applications for non-household customers who have installed photovoltaic panels, which make up 75.6% of the total number of self-producing customers.

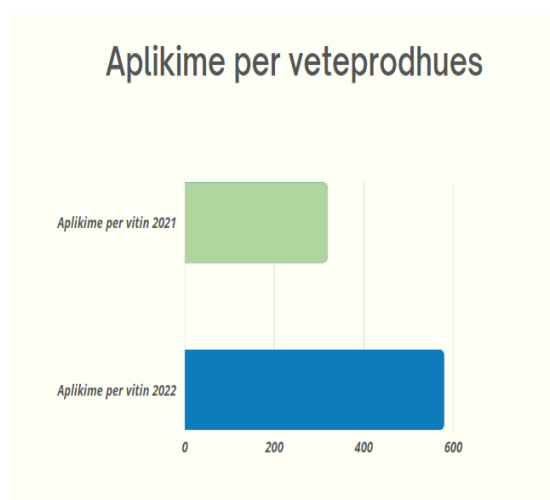

While during 2021 there were about 206 applications for the exercise of the activity of self-producer from the end-use customers, only for 113 of them the application for the exercise of this activity and the connection to the network was approved by DSO company.

From the collected data, it results that the total consumption by self-producers in 2022 (for 579 applications) produced amount is about 12,713,154 kWh, while in 2021 (for 319 applications) self-producers have produced an amount of about 2,674,615 kWh. Increase in the production of electricity by self-producers for 2022 compared to 2021, it is about 78%.



Since the issuance of Instruction no. 3, dated 20.06.2019, of the Minister of Infrastructure and Energy, "On the approval of the simplified authorization procedure for the connection to the distribution system of small renewable projects for self-producers of electricity from the sun" and the approval of the implementing acts either by ERE or the institutions of responsibility, according to the data submitted by DSO company, it results that the total number of customers who today hold the status of self-producers is 1025 with a total installed capacity of 102618 kWp from this category of producers.

From the data submitted by DSO company it has been found that Durrës and Tirana are the areas where there have been many photovoltaic plants installed for self-producing customers. This is related to the great potential of these areas to guarantee the efficiency of photovoltaic production units due to the number of sunny days necessary for this type of technology.

On the other hand, in order to provide a clearer picture, ERE has requested information from subjects that sell and install photovoltaic panels, regarding the degree of interest shown during the period March 2021-March 2022 by customers, as well as an assessment regarding the rate of return on the investment made for these plants.

Regarding the above, information was submitted from 2 dealers of photovoltaic panels, one of which informed that the treated plants are non-household customers, mainly light industry, fashion industry and heavy industry. The company counts over 20 supplied plants with a MAX capacity of over 3.5 MWp and 5 MWp, contracted and in the process of implementation and supply. Another company trading photovoltaic panels has informed that for the period March 2021-March 2022 the market of photovoltaic systems has had a significant increase. One of the factors that gave impetus to this sector was the increase in the power exchange market.

Also within the framework of the measures taken by the Albanian government to reduce the consumption of energy from the national grid, there is also an initiative to subsidize 70% of the costs from the Albanian government for 2000 applicants. Applications for subjects that shall provide and install solar panels for heating water have been open for 01.10.2022-18.10.2022 period. All interested subjects submitted the required documentation electronically to e-mail info@eficenca.gov.al or physically at the AEE offices by 18.10.2022. After this date, the documentation was evaluated by a joint commission of MIE and AEE. At the end of the evaluation, AEE has published the list of entities that are part of the solar panel subsidy scheme for heating water.

9.5 Secondary Legislation for the customer

Throughout 2022, a series of acts have also been approved that aim to specifically regulate the range of rights and obligations of electricity customers.

Regulation on the measures of the licensees in electricity supply activity for the achievement of the indicators prepared by ERE for measuring and evaluating the performance of customer service - Among other things, this act aims to inform customers to make choices based on the information provided, to support their rights, including the right to choose their electricity supplier. The scope of these measures for licensees in the supply activity includes the modalities on which ERE supervises and evaluates the achievement of service performance measurement indicators. ERE's goal in terms of customer protection is to protect the interests of customers as a whole, based on equal and non-discriminatory treatment through legal and transparent procedures. Also, the monitoring and control of the services provided by the licensee to electricity customers.

Some amendments to ERE Board decision no. 181, dated 23.11.2016, "On some amendments in ERE Board Decision no. 104, dated 23.06.2016, "On determining the methodology of reference values in case the measurement data are temporarily unavailable and inaccessible, as well as on the annulment of ERE Board Decisions no. 49, dated 21.10.2004 and no. 146, dated 24.12.2013" By means of decision no. 104, dated 23.06.2016, ERE approved the methodology of reference values, in which it was foreseen that in cases where measurement data is unavailable, it would be taken for reference in calculation of electricity consumption, the last 3 years of the same month. ERE, after reviewing and evaluating the implementation of this new act, decided that the reference values for 2022 and beyond shall be calculated based on the same month of the previous year, assessing that all indicators proved that it is closer reality. For the latter, a comparative analysis of the complaints registered during the application, on the mode of invoice calculation, was also considered.

Some additions and amendments in ERE Board Decision no. 60, dated 25.02.2021, "On approving the standards of handling the electricity and natural gas customers complaints from the licensees in the supply activity". Following this regulation approved by ERE Board during 2021, following the proposals of DSO company, the criteria defined in the annex of the regulation on

the reporting modality of licensees were further detailed. The object of these standards is to determine the general conditions for handling complaints and requests of energy customers from the Licensees for the Energy Supply Activity.

ERE's strategic objectives for 2021, according to the plan of measures for the implementation of ERE's strategic objectives for 2021 – 2023 period, as well as the update of the plan of measures for ERE's strategic objectives for 2022 - 2023" Throughout 2022, the pursuit of objectives strategy has continued according to the provisions of the aforementioned act. In this important act, the objectives, tasks, deadlines for the implementation and continuous follow-up of the 3-year objectives provided by ERE are clearly defined. Among the tasks charged in this document that directly address customer issues, are:

The organization of the cooperation tables with the customer offices in the municipalities of the country, as well as the organizations created for this purpose, are related to meetings in which it is envisaged to present the legal framework that regulates the power sector as well as the role of ERE in addressing of customer issues.

Organization of training for interest groups with the object "Information on Customer Rights, which consists of the role of various institutions in terms of customer protection, including the rights and obligations of the latter." As part of the informational campaign related to customer rights, informational brochures are included, as well as the possibilities of access to customer information.

The operation of the toll-free number for customer information ensures a cost-free communication between the customer and ERE, through which assistance and information is provided regarding the status, and further handling of the complaint or any ambiguity created.

Indicators for the standard criteria of the supply quality service and the security performance

Indicators for the standard criteria of the supply quality service and the security performance of the electricity distribution grid for 2021.

ERE Board with decision no. 97/2021 approved the indicators for the standard criteria of the supply quality service and the security performance of the electricity distribution grid for 2021. DSO company submitted at ERE the periodic reports regarding the indicators for the quality of the electricity distribution service, as defined in the regulation on the standard criteria of the supply quality service and the security performance of the electricity distribution grid approved with ERE Board decision no. 181/2017 as well as decision no. 97/2021. The Albanian Government with Council of Ministers decision no. 584, dated 08.10.2021, "On the Declaration of the State of Emergency in the Electricity Supply", amended by Council of Ministers Decision no. 650, dated 10.10.2022 decided to declare a state of emergency in the electricity supply, the effects of which have been postponed until December 31, 2022. The above decision-making, among others, is also based on the provisions of point 4, article 90, of law no. 43/2015, amended, which stipulates that: "The licensees are not responsible for the sanctions incurred as a result of the interruption or limitation of electricity, for the cases provided for in point 1, of this article, except for cases where the emergency situation comes as a direct result of the fault of the licensee".

The standard criteria of the supply quality service of the distribution grid remain unchanged for 2022 with the indicators in force approved with ERE Board decision no. 97/2021.

These indicators are considered separately according to urban and rural areas.

Comparison of DSO Performance in TL+TM+TU 2020-2021 Regarding the Main Indicators SAIFI, SAIDI, CAIDI

	SAIFI		SAIDI		CAIDI	
	No. of Customers affected by interruptions.	Total no. of Customers	No. of hours of Total interruptions.	Total no. of Customers	No. of hours of total interruptions /No. of customers	Affected by interruptions
	2021	2022	2021	2022	2021	2022
January	3.42	2.65	7.4	4.36	2.18	1.65
February	2.76	2.68	5.6	6.43	2.04	2.4
March	1.98	2.38	4.27	5.51	2.16	2.32
April	1.65	3.65	2.73	5.57	1.65	1.58
May	1.7	2.36	2.89	4.1	1.7	1.74
June	2.22	2.49	3.52	3.92	1.59	1.57
July	2.3	2.16	4.02	3.02	1.75	1.59
August	2.0	2.40	3.28	3.41	1.64	1.40
September	1.92	2.49	3.15	4.35	1.64	1.42
October	2.67	1.80	5.15	3.38	1.9	1.87
November	2.65	2.89	5.32	5.26	2.01	1.82
December	3.31	2.97	6.69	4.47	2.02	1.61
GRAND TOTAL	28.50	31.16	53.95	54.68	1.89	1.75

As for SAIFI or System Average Interruption Frequency Index, its value turns out to be 31.16 hours. The value determined by ERE for SAIFI (Average Interruption Frequency Index) with decision no. 97/2021 is 25.08 hours.

For SAIDI or the Index for the average duration of the interruption, its value turns out to be 54.68 for the year 2022. The value determined by ERE for SAIDI (Index of Average Duration of Interruption) with decision no. 97/2021 is 47.17 hours.

According to DSO company reports, 2022, compared to 2021, has an increase from 19% to 23% in the specific weight that interruptions due to atmospheric conditions occupy in the total performance of the network. As it is identified from the studies reported by DSO company in January-December 2022 period, the indicators have not followed the downward trend they had during the

annual periods until 2020, but have increased due to bad weather with all the technical and organizational measures taken by DSO company where there have been extreme weather conditions, accompanied by low temperatures, strong winds and flooding, which has brought numerous interruptions to the network.

According to the declarations of DSO company the rural and deep areas where the 6/10kV aerial network dominates, the number of interruptions is still high and this significantly affects the indicators of the continuity of the total supply of the distribution network, accounting for almost 80% of the total. In these areas, the stability of the network, although there is improvement, is still low, which is reflected in the large number of damaged feeders in the distribution network during bad times.

DSO company reports that the number of interruptions from third parties continues to be difficult to determine, especially at the low voltage level, which does not include the interruptions caused by private cabins that supply household customers, because in in these cases it is difficult to identify the causes mentioned and the problems with the ownership of private cabins and of course how it affects the calculation of SAIDI and SAIFI. These cases pass as termination of the responsibility of DSO company, distorting the cause of the interruption.

The indicators realized in the calculated values carry a margin of error for the following reasons: The system used to evaluate the continuity of supply as stated by DSO company carries risks for obtaining the results, since all information is recorded and calculated manually. The greatest weight in the margin of error in the unmonitored network shall be the reporting and collection from the field: of all

network outages, a process which despite the measures taken to minimize it still continues. This process is difficult to verify mainly in the TM network which has no number for monitoring. Reporting by phone and then recording in the book of operational talks, lack of infrastructure, lack of phone waves in different areas affect the accumulation of this margin of error.

In increasing and maintaining quality standards, a significant role is played by the installation of a safe measurement system. DSO company informs that the measurement system has been implemented to the extent of 100% in the country. Meanwhile, as regards the installation of intelligent metering systems, the steps taken in this direction have moved at a slow pace, also due to the massive investments required by the Network Operator. The smart meter can immediately inform the network operator if there is a power outage in a certain area, which means that the network operator can react in a faster time to restore the service or correct the fault.

Standards for quality of supply and network security performance in the electricity transmission system

ERE Board with decision no. 207, dated 18.12.2017, approved the "Regulation on the quality of supply and network security performance in the electricity transmission system", which provides for the public service obligation of the Transmission System Operator (TSO company) to meet the standard for quality of supply specified by the Transmission Network Code and by this Regulation.

With the proposal of TSO company seeing the trend of improving quality indicators and adhering to the values approved by decision no. 255, dated 21.12.2020, the Board of ERE decided to approve the Indicators of the standard quality criteria of the electricity transmission service for the 2022. TSO company accurately submitted data on a 3-month basis on the progress of these indicators in accordance with decision no. 244, dated 02.12.2021 on the Indicators of the standard quality criteria of the electricity transmission service for the 2022.

Table below: Measurement Indicators for the Quality of Supply and Security Performance of the Transmission Network during the 4 quarters of 2022, Performance of 2022 in view of the Standards approved by ERE for 2022.

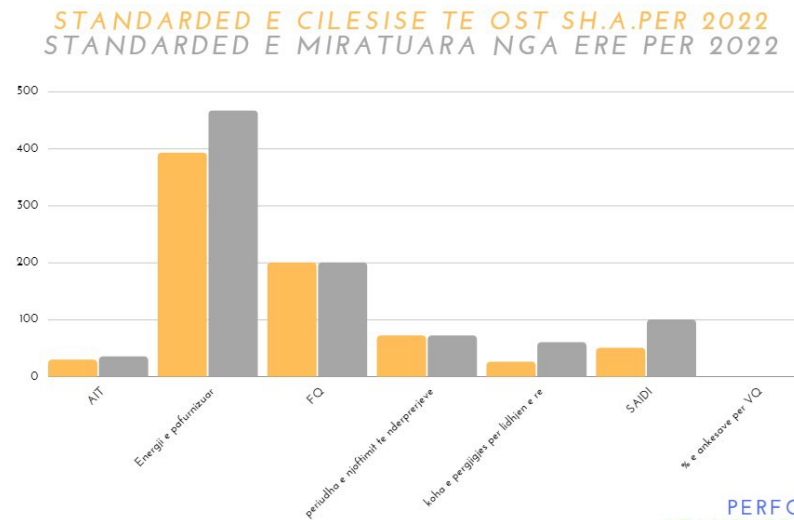

Referring to the diagram, the standard service quality criteria reported by TSO company are presented in orange for 2022, while in gray are presented the standards approved by ERE with decision no. 244/2021. From the presented criteria, a reduction in all indicators is clearly seen, seen differently as an improvement trend for 2022

On the right, the Performance of TSO company is presented in analytical graphic form. For 2022 compared to the Standards approved by ERE for TSO company for 2021 with Board no. 255/2020.

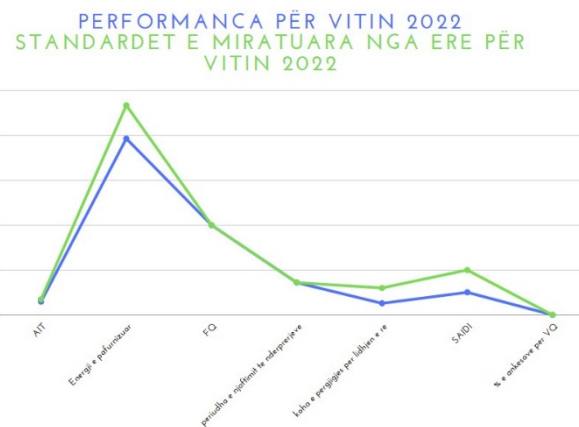

These indicators, as noted above, are in accordance with ERE Board decision no. 244/2021, and some of them are improved. It shall be mentioned that the parameters above such as Average Supply Interruption Time with Electricity has decreased to 29.58 min from 35 determined in the decision, as well as Unsupplied Energy seems to have improved a lot in the values of 392 MWh from 467 MWh approved. Also, important indicators such as SAIDI (Index of Average Duration of Interruptions) continue to decrease this year to 50.43 min out of 100 approved in the ERE decision. The value of this indicator is almost halved even by the proposal of TSO company for 2022. However, the Time Needed to Respond to Requests for New Connections has been reduced to 26 actual days, or half of the time approved by ERE with the operator's proposal for 2022.

	KPI 2022	KPI 2021	KPI 2020	KPI 2019
Average Interruption Time (AIT)	9.58 min	28.76 min	35 min	35 min
Energy not Supplied (ENS)	392.731 MËh	433.035 MËh	463.53 MËh	467.87 MËh
the Periods for the Notification of the Planned Interruptions in the	72 h	72 h	72 h	72 h

Transmission System				
Necessary time to respond to new connections	26 days	32 days	60 days	60 days
the Index for the average duration of the interruption (SAIDI)	50.43 min	70.31 min	71 min	104 min
Voltage Quality (VQ)	Within the range: 10%, +11.8	Within the range: 10%, +11.8.	Within the range: 10%, +11.8.	Within the range: 10%, +11.8.
Percentage of the complaints for the quality of voltage	There is not	There is not	There is not	There is not

Figure 106 Measurement Indicators for the Quality of Supply and Security Performance of the Transmission Network

As above, TSO has reported Key Performance Indicators in tabular form, including parameters from 2019 to 2022.

It is also noted that these indicators during 2022 have significantly improved compared to previous years.

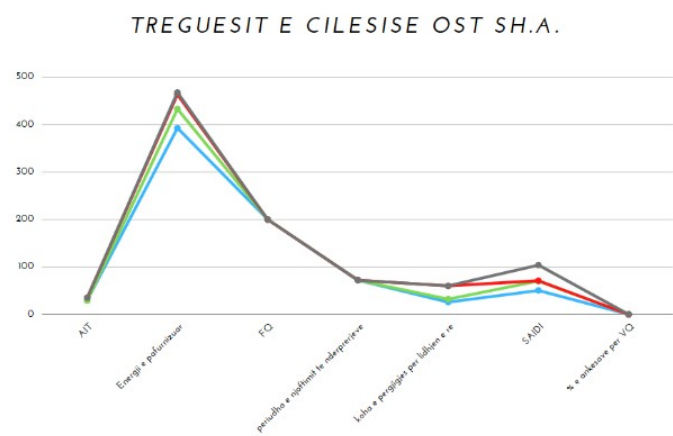

An analytical graphic of quality indicators over the last 4 years is presented on the side. From the findings, for 2022 the quality parameters related to energy not supplied, the necessary time to respond to requests for new connections have improved significantly compared to previous years, while the Index for the average duration of the interruption (SAIDI) has clearly decreased from 70.31 min to 50 min, which results in an improvement as shown in the graphic on the left. The only indicator that has seen a slight increase compared to 2021 is the average duration of the interruption, which increases to the value of 29.58 min. This increase does not affect the licensee in fulfilling the standards approved by ERE with decision no. 244/2021.

Access to the Distribution Network and Transmission Network

Based on Law 43/2015 on Power Sector and the Regulation on new connections in the distribution system approved with ERE Board Decision No. 166, dated 10.10.2016, , amended by ERE Board Decision No. 177, dated 08.11.2016 and Decision No. 133, dated 06.06.2022, the Distribution System Operator shall regulate agreements with users of the distribution system who seek to make a new connection or modify their existing connections in the Distribution System, shall determine the procedures, deadlines and the tariffs for the performance of this service by DSO company as well as shall achieve a unification of the quality of works, standards and technical characteristics of new connections in the electricity distribution network.

Regarding access to the distribution network, during 2022, it results that there were a total of 21157 applications for new or additional power connections in the distribution network, of which 17927 are applications for New Connections and 3230 applications for Additional Power. Compared to 2021, the grand total of applications has increased by nearly 20%, respectively applications only for new connection go from 14108 applications in 2021 to 17927, 22% while applications for additional power go from 2900 for 2021 to 3230 about 11%.

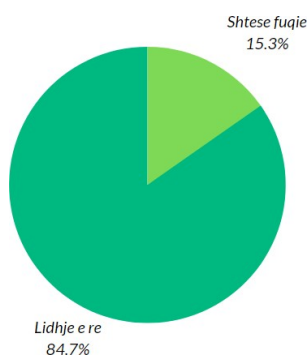

As evidenced by the graphic on the left, 84.7% of the applications are for New Connections and 15.3% are for Additional Power.

As in 2021, Tirana, Durrës and Shkodra continue to occupy the majority of applications for new connections, for each category. Kukësi continues to remain the region with the fewest applications for new network connections.

Within the total applications for 2022, DSO company has also provided the status of these applications, among others the completed status occupies half of the total of these applications with 12634, while the rejected cases are 1048.

The reasons for rejected applications during 2022 continue to remain the same as those of 2021: Lack of Documentation; The advance payment has not been made for a long time; the applicant turns out to be a debtor; the object applied for is unfinished; ownership issues.

An important part of the exercise of the activity by TSO company as for the obligations for the implementation of the License Conditions for the Broadcasting service, it is also the implementation of the conditions and deadlines provided for in the "Regulation of Procedures for New Connections and Modification of Existing Connections to the Transmission Network", approved with ERE Board decision, no. 87, dated 20.04.2018. For this purpose, ERE has requested from TSO to provide detailed information regarding the applications registered in TSO company for New Connections in the Transmission System, the procedural deadlines followed for the approval or rejection of each application, as well as in cases of rejection, the reasons for this rejection, the number of generating units that have been put into operation.

Regarding access to the Transmission Network, it shall be noted that compared to 2021, there is an increase in the number of applications from 27 to 117 applications for new connections, about 4 times more than in 2021. As for the issue of generating units, 2 sources in 2021 are put into operation, while in 2022 only 1 generating unit.

During 2022, there were 4 applications for "Hydrogen Generator, of which 1 connection agreement was realized"; 92 applications for "Solar Generator", 2 agreements realized; 19 applications for "Wind Generators", no agreement realized; and 2 applications for "Thermal Generator", with no agreement realized. Compared to 2021, the demand and interest for application and connection agreements in the transmission network for all new sources of electricity production has increased.

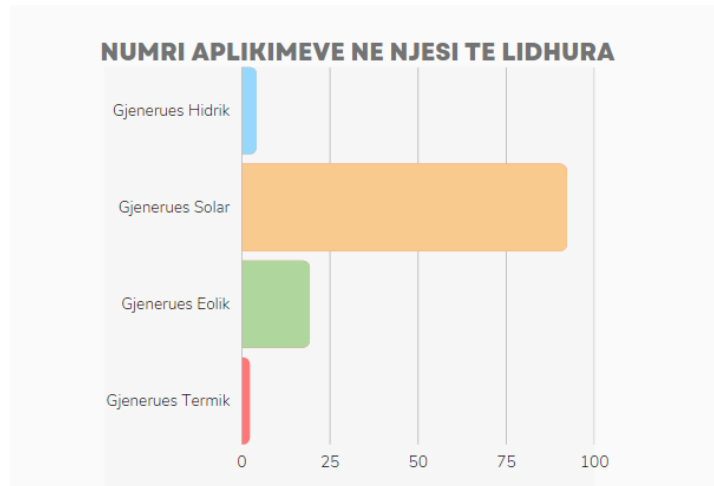

As mentioned, in 2021 there was 1 approved application for "Hydrogen Generator"; 14 applications for "Solar Generator"; 12 applications for "Wind Generator"; and no application for "Thermal Generator".

Regarding the legal deadline for feedback (60 calendar days) according to the "Regulation of Procedures for New Connections and Modification of Existing Connections to the Transmission Network", TSO company submitted the responses within the time limit, defined in regulations except for 4 cases which are still in the process.

As for the evaluations of the applications according to the reports of TSO company it results that the Preliminary Opinion occupies the largest weight of 70% of the total applications submitted for the period of January December 2022. From the records made with the 2021 annual report, the preliminary opinion has taken the majority of the weight and the previous year with 63% of cases.

9.6 Monitoring of licensees in public service activities.

During 2022, ERE has conducted 5 monitoring of licensees, with the aim of supervising the fulfillment of the latter's obligations regarding the implementation of the provisions of regulatory acts related to the quality of customer service.

Monitoring of FSHU company on the deadlines and procedures for handling complaints, which was carried out in connection with the implementation of the deadlines and procedures for handling complaints registered in FSHU company during 2021, with the aim of implementing the deadlines and procedures of handling of complaints registered at FSHU company during 2021 from all sources. ERE verified the practices related to issues such as: over-invoicing of electricity, economic damage, reference value invoicing, various complaints related to invoicing after the suspension of electricity, invoicing payment methods, original invoices or the time of contract opening and a contract reactivation case. According to the findings of ERE, it was observed that from FSHU company the complaint handling documentation is kept in accordance with the provisions specified in "The standards of handling electricity customers complaints from the licensees in the distribution and retail supply of electricity activities", approved with ERE Board Decision no. 60, dated 25.02.2021. Regarding the implementation of deadlines and procedures for handling complaints of electricity customers, it is noticed a great commitment of the FSHU company, regarding the solving of problems related to customer complaints. The working group after exercising the control in FSHU company

and after analyzing the collected and observed data, has concluded and recommended for the licensee to take measures for the timely treatment of complaints for all electricity customers, respecting the stipulations established in the "The standards of handling electricity customers complaints from the licensees in the distribution and retail supply of electricity activities", approved with ERE Board decision. Taking measures to optimize the customer care platform, in order to inform the Customer about the current status of the advertised problem as well as informing the customer about the resolution of the complaint. Submitting the written response to the customer for the resolution of the complaint, as well as FSHU company must inform the complainant of the right to appeal his decision at ERE.

The monitoring of TSO company regarding the deadlines, procedures and complaints for new connections in the transmission, which was carried out in order to monitor TSO company in terms of ensuring the access of third parties in accordance with the requirements of law 43/2015 "On Power Sector", as amended, as well as the Regulation of Procedures for New Connections and the Modification of Existing Connections in the Transmission Network, approved with ERE Board decision no. 87 dated April 20, 2018, the procedures followed as well as the observance of the application review deadlines, approval and implementation of the new connection, including the handling of complaints from applicants for new connections. At the end of this monitoring, the working group did not find any irregularities or deviations from the legal and by-law provisions that administer the modalities of new connections and the modification of existing ones in the transmission system.

Monitoring of DSO company with the object of monitoring the achieved standards for quality of supply and network security performance of the electricity distribution network for the period January 2021- March 2022. By means of decision no. 97, dated 07.04.2021 ERE has approved the Standards for quality of supply and network security performance of the electricity distribution network for 2021. ERE exercised the monitoring to verify the achievement of these standards, the implementation on the ground of the measures provided for in the aforementioned regulation, but since this monitoring took place under the conditions of the declaration of the State of Emergency, where according to Council of Ministers decision no. 256, dated 29.04.2022, "For some amendments in decision no. 584, dated 08.10.2021, "For the announcement of the state of emergency in the supply of electricity" it was decided: Point 5 of Council of Ministers decision no. 584/2021 is amended as follows: "The state of emergency in electricity supply extends its effects until December 31, 2022, the findings of this monitoring shall be evaluated as part of a new monitoring which shall include the period of almost 2 years, during which DSO as well as other operators have been under the impact of the global crisis of the energy system.

Monitoring of TSO company was carried out at TSO company had as its object the achieved standards for quality of supply and network security performance of the electricity transmission network for the period January 2021-March 2022. After processing the data from ERE, it is evidenced the compliance with the obligation to maintaining the voltage within the parameters allowed according to ERE regulation and the transmission code for all the elements that these acts provide. At the end of this monitoring, the working group has evaluated and recommended for the TSO company; The SCADA/EMS system must be completed with data from all elements of the 110/220/400kV network, in order to ensure a more complete observation of the network as well as to have full input into the network applications (EMS). In this regard, TSO company must analyze all the necessary possibilities and plan the expansion and completion with data of the SCADA/EMS system, so that these data are received and processed in real time and do not allow spaces for contestation by the parties; TSO

company shall continue with investment planning based on the criteria of prioritization and the impact of improving service quality indicators for the rehabilitation of the network, mainly the reconstruction of its substations in the direction of the regular completion of the primary tracts of the substations mainly the elimination of knives and the placement of switches and other necessary elements to enable the connection of these substations of the SCADA system in TSO company.

TSO company shall evaluate the possibility of automating the process of receiving and processing data and their calculation by means of a software in order to increase the transparency and reliability of the data and the calculation efficiency of the main indicators. TSO company must make a full technical-economic assessment for the full implementation of the "Regulation for the quality of supply and performance of network security in the electricity transmission system" approved with ERE Board Decision no. 207, dated 18.12.2017, including the provisions for financial compensations.

ERE, after analyzing the available data and after the inspection at TSO company concluded that it did not observe any irregularities or deviations from the legal or by-law provisions in force.

Monitoring related to the obligations and periodic reports as well as the supervision of the implementation of the tasks derived for the licensee from ERE Board decision no. 201/2018, reviewed by decision no. 217/2020 "On reviewing the "Measures plan for the Distribution System Operator of Electricity "OSHEE" Company to respect the rights of electricity supply customers". The measures plan is an important act approved with ERE board decision no. 201/2018 and reviewed with decision no. 217/2020 as a task left by the Assembly. ERE every year has continuously exercised monitoring to observe the achievements foreseen in the measures plan. It turns out that year after year, FSHU company has improved the measures foreseen in the measures plan, but it still cannot be said that the foreseen measures have been achieved to the extent of 100% on their part. Regarding FSHU company there were deficiencies in the periodic reporting of the progress of the implementation of the measures foreseen in the measures plan.

Monitoring of FSHU company was carried out regarding the obligations and periodic reports as well as the supervision of the implementation of the duties arising for the licensee from ERE Board decision, no. 201/2018, reviewed by decision no. 217/2020 "On reviewing the "Measures plan for the Distribution System Operator of Electricity "OSHEE" Company to respect the rights of electricity supply customers". Regarding this monitoring, it has been concluded that the company has generally implemented the obligations foreseen in relation to the implementation of the "Measures Plan", approved with ERE Board decision no. 201, dated 03.09.2018, as amended. In the following, ERE presented recommendations, based on the findings of the working group where FSHU company must strictly implement the general conditions of the universal service contract for the supply with electricity of the end use customers, approved with ERE Board decision no. 15, dated 10.01.2018, and in particular the provisions of point 16.4, which stipulate that: "The end-use Customer may object at any time the invoice issued by the Supplier but not later than 1 year from its issuing date, when he suspects in the invoicing accuracy, other errors observed in the invoice or inaccuracies in the metering system" since these complaints are especially related to the financial element. Further, ERE recommended that the website of FSHU company shall harmonize an information made public on the website of FSHU company with the website of OSHEE company since the latter contains more detailed information. FSHU company should also continue the work to facilitate access and service for persons with disabilities and others with specific needs, as well as provide any assistance that may be necessary for persons with disabilities. Finally, ERE has recommended that FSHU company should continue the work for the reflection (expansion) of the data in the invoice that the electricity law, or even the acts issued in its implementation, have provided as an obligation for all suppliers. ERE shall monitor the work of the Universal Service Supplier towards the standards established in the regulatory

acts and in accordance with the tasks under this measures plan. The measures plan is a continuous process where ERE supervises the implementation of these measures between correspondences or monitorings that are carried out year after year according to the monitoring calendar periodically approved by ERE. The periodic information submitted by FSHU company as defined in this measures plan, and the findings evidenced in the information prepared by the technical staff of ERE, from the specific monitoring as cited above, serves for the assessment by ERE of the provision of services and ensuring the respect of customers' rights.

10. ERE INTERNATIONAL ACTIVITIES

10.1 International Relations

ERE priority is and shall remain the dignified and active representation of the Regulator in regional and international activities, aiming the consistency and harmonization of its practices with the ones of region and EU countries. The participation in international activities is considered by ERE as one of the main elements that serves to institutional strengthening, increasing the knowledge and

For 2022, ERE has collaborated in intensifying the multilateral relations with international organisations like Energy Secretariat in Vienna, throughout ECRB or also via associations such as MEDREG, ERRA, NARUC, CEER, IGU etc. During the last year ERE paid special importance to the participation in the workshops, meetings and other international activities. The interest of our institution staff in these activities was high with the aim to be informed with the best international experiences and the latest developments in the power sector by participating on these international activities as well as to present the regulatobbb r with dignity on these activities through various speeches, chairing meetings or working groups or various presentations in seminars or meetings.

10.2 Active Participation as a Member International Organization

ERE is a full right member of the Regulatory Authorities Association for the South East Europe and Euro Asian Countries (ERRA), by realizing a regular participation at ERRA Chairman General Assembly, meetings of ERRA permanent Committees, as well as the Working Groups that of Electricity, natural gas and that of Tariffs, Prices or customer.

ERE is a member of the Regulators Association for the Mediteranean Countries (MEDREG) for electricity, where during 2022 ERE Chairman held the President of MEDREG post a term which ended in December 2022. Also, ERE staff has actively participated at the working group meetings including their direction for the customers working group, institutional relations, renewable energy, gas issues, the electricity working group being the drafters of the working group materials or reports.

ERE has the observer status at CEER (Council of European Energy Regulators), a status which enables the strengthening and picking up knowledge of ERE staff during participation in working groups and General Assembly meetings.

ERE is participant at UfM (Unioni for Mediteranean) meetings, which is composed of 43 Member Countries part of the Mediteranean and aims to increase and strengthen the regional cooperation as well as implementation of the projects and initiatives that shall serve to the region. In the framework of cooperation in the power sector, UfM drafted the platform for natural gas sector as well as two other platforms for the power sector, regarding renewable resources and energy efficiency

ERE is a full right member of the South-South-East Gas Regional Initiative (GRI SSE), which is the Initiative of Gas Regulators in the South-South-East Region.

Also ERE is a full right member of OME (Energy Observer for Mediterranean and Europe) a very important forum of the Mediterranean.

As a full right member of the Balkan Advisory Forum, which includes the Regulators of Montenegro, Northern Macedonia, Greece, Serbia, Bosnia and Bulgaria, ERE staff participated at the meetings of the working groups of this Forum as well as the draft of reports that serve the regulator and stakeholders. The forum serves to exchange experiences between these regulators through the establishment of working groups in areas of common interest.

For 2022, ERE has continued to maintain a fruitful cooperation with USAID and NARUC in the joint project, supported by USAID and NARUC regarding the implementation of the cyber strategy.

Also, ERE has participated in the USAID & NARUC project related to the drafting of 10-year plans for the development of transmission networks in Southeast Europe, as well as the organized workshop related to cyber security issues.

ERE in the framework of Energy Community Treaty during the last year participated on Athens Forum, Gas Forum and Energy Community activities organized by Vienna Secretariat as well as the working groups of this organization.

Also ERE participated on activities intensively collaborating with the Energy Community Secretariat in Vienna, being consulted for the main decisions and asking for opinions for delicate issues. Likewise, the draft decisions taken by us as well as the draft regulations drafted by us have been sent to the Vienna Secretariat for consultation or meetings have been held with them to improve decision-making, as well as the assistance of the Vienna Secretariat in the drafting of secondary regulatory acts. ERE has regularly and actively followed the ECRB Working Group meetings on customer issues, energy and its regional market, renewable resources, statistics, electricity, efficiency, security of supply, REMIT, natural gas. In order to carry out the best possible work and achieve high results, ERE has held joint meetings with the Vienna Secretariat regarding the implementation of the Network Codes, the approval of which comes as an obligation derived from the Energy Community Treaty and ENTSO-E.

In December 2022, in cooperation with the regulators of Italy, Bosnia and Herzegovina, Montenegro and North Macedonia, the Balkan School of Energy has been established based in Milan, which shall serve for the exchange of experiences between regulators.

10.3 ERE Bilateral Relations

During 2022, bilateral relations with the Italian Regulator (ARERA) as well as the Greek one (RAE) were further intensified. This cooperation has made possible the continuation of the timely implementation of the joint decisions of the three regulators regarding the TAP project, which began operating at the end of 2020.

11.ENERGY REGULATORY AUTHORITY ORGANISATIONAL CHART AND ADMINISTRATION OF HUMAN RESOURCES

Implementing Law no. 43/2015 “On Power Sector” as amended, article 9 point 1, defines that ERE is the Regulatory institution of Power and Natural Gas Sector in Albania which is governed by the Board of Commissioners. ERE Board of Commissioners is composed of the Chairman and four Board members which are appointed by the Assembly with a 5-year term.

The Energy Regulatory Authority is organized in accordance with ERE Board decision no. 78, dated 29.04.2020. The organizational structure and organizational chart of ERE consists of 63 technical employees, as well as 6 external staff, support employees and auxiliary employees, organized and according to the functional hierarchy by the General Secretary, 7 Directorates and 5 Sectors.

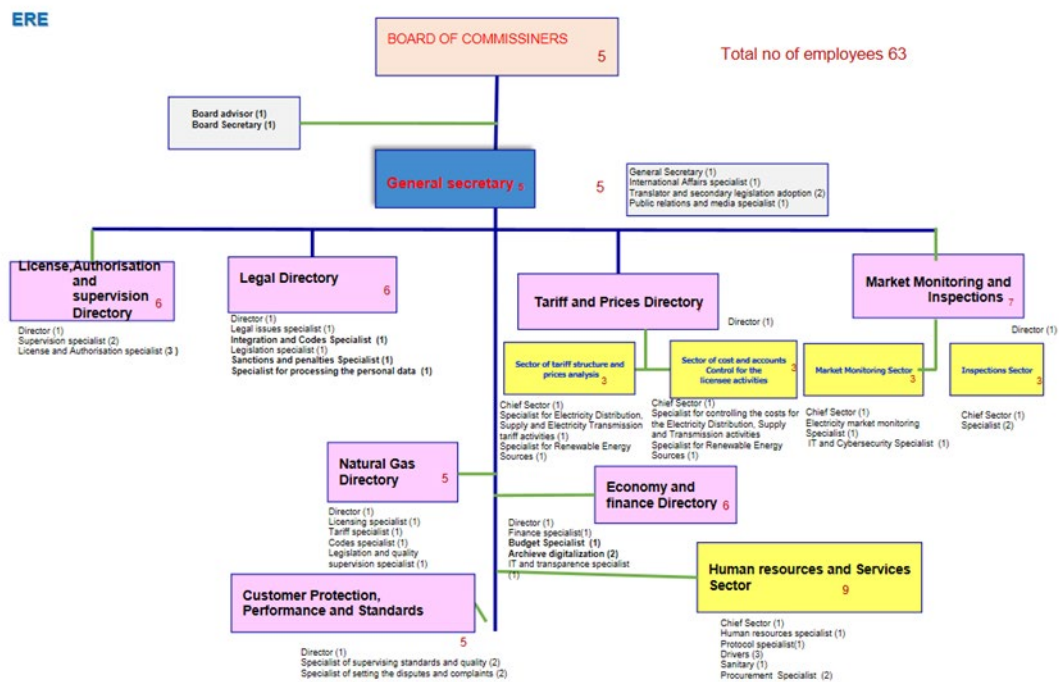

Figure 107 Energy Regulatory Authority organisational chart

The structure of ERE is based on a clear division, with the necessary capacities, in order to fulfill the tasks and responsibilities related to the areas of regulation by ERE in implementation of the legislation in force, such as: Customer Protection, Drafting and approval of Bylaws, Development of the Natural Gas Market, Market Monitoring, Quality Standards, the impose of Tariffs and Prices in Regulated Market Segments, Licensing, Modification, Renewal and the granting of Authorizations for operations in the activities identified in the respective laws, Institutional relations inside and outside the country, Budget Planning, Human Resources Development.

This structure also takes into consideration the latest developments in the power sector, and is adapted in such a way as to allow ERE to fulfill the obligations arising from the legal acts in force.

Following Law no. 43/2015 "On power sector" as amended, on the selection, appointment and promotion of ERE employees, the procedures of law no. 152/2013 "On the civil servant" as amended, and the legal acts in its implementation, and the selection of four Directors of Directorates and three Sector Managers of organizational structures according to the procedures of this law, as well as the procedures for the confirmation of ERE employees. Throughout 2023, the competition procedures for other positions of the Energy Regulatory Authority shall be continued in accordance with the above-mentioned legal acts, as well as the procedures for the confirmations in duty of the positions that have passed the selection phase and the trial period according to the legal provisions shall be carried out.

Following its membership in the European Union, Albania is engaged in a deep reform of its power sector as well. In this regard, various programs have been initiated with foreign institutions and experts to identify the Gender Dimension/Diagnosis (which explores the current gender situation in the Albanian power sector, including the identification of challenges that prevent women from being actors of change in this sector, and examines possible evolutions in the context of the implementation of the energy reform, the National Strategy for Gender Equality) and the current gender situation in the Albanian power sector.

Within the framework of this program, in close cooperation with the actors involved in the power sector reform, ERE has engaged and offered its cooperation with various institutions and experts regarding the identification of "Current gender diagnosis in the power sector in Albania" finalized with the report in October 2022.

In the Energy Regulatory Authority during 2022, the gender representation in the total number of active employees was presented in the ratio of 65% for the female gender and 35% for the male gender, while this ratio at the management levels is 40% female and 60% male. Referring to the gender diagnosis in the power sector, ERE is represented by mostly the male gender.

There are also reflected the changes that occurred during 2022, approved with the Council of Ministers decision "On the salaries of support workers and other employees of various specialties in some public administration institutions", respectively with No. 234 dated 20.04.2022, Council of Ministers decisions no. 621&627 dated 28.9.2022.

On amendments in the salary level of civil servants/employees according to Decision no. 187, dated 08.03.2017 "On approving the structure and salary levels of civil servants/employees, deputy ministers and cabinet officers, in the Prime Minister, the apparatuses of line ministries, the administration of the President, the Assembly, the Central Election Commission, the Supreme Court, the General Prosecutor's Office, some independent institutions, the institutions subordinate to the Prime Minister, the institutions subordinate to the line ministries and the Prefect's administration" with Council of Ministers Decision no. 621 on 28.09.2022.

During its activity, ERE, in order to operate and administer and exercise its powers, in accordance with the relevant legislation in 2022, approved the following regulations:

- 1- "On the Organization and Operation of the Archive and Secretary/Protocol Service in the Energy Regulatory Authority" approved with ERE Board decision no. 221, dated 01.09.2022.

This regulation defines the organization and operation of the archive and secretary/protocol service in the Energy Regulatory Authority; as well as Processing, storage and administration of documents,

for entry-exit, delivery and technical-scientific processing of documents, as well as for the expertise of the value of document storage and the technical conditions for their storage. Functions which are regulated based on relevant legislation such as: Law No. 9154, dated 06.11.2003 "On Archives"; as well as by-laws issued in its implementation; Law No. 8457, dated 11.02.1999 "On State Secret Classified Information" and by-laws issued pursuant to it; Technical-professional and methodological norms of the archival service in the Republic of Albania.

2- "On the Prevention and Addressing of Violence, Harassment and Sexual Harassment in the Work Environment of the Energy Regulatory Authority" approved with ERE Board decision no. 315, dated 06.12.2022.

This regulation was drafted based on to international instruments (such as: the Universal Declaration of Human Rights, the International Covenant on Civil and Political Rights, the International Covenant on Economic, Social and Cultural Rights, the International Convention on the Elimination of All Forms of Discrimination Racial, the Convention on the Elimination of All Forms of Discrimination against Women, the International Convention for the Protection of the Rights of All Migrant Workers and Members of Their Families and the Convention on the Rights of Persons with Disabilities) Law no. 13/2022 "On the ratification of convention 190 "Convention on Violence and Harassment" of the International Labor Organization, 1986". as well as legal acts (such as: Law no. 7961, dated 12.07.1995 "Labour Code of the Republic of Albania", Law no. 152/2013, "On civil servants", as amended; Law no. 9131, dated 08.09. 2003, "On the rules of ethics in public administration"; Law No. 10221, dated 04.02.2010, "On protection from discrimination"; Law No. 9970, dated 24.07.2008, "On gender equality in society") and bylaws of issued in their implementation as well as the Guidelines for the Prevention and Addressing of Violence, Harassment and Sexual Harassment in the Work Environment in State Administration Institutions.

In reference to the above and for the implementation of these indicators, ERE has approved this regulation which aims to engage all employees to create, guarantee and promote a safe work environment by preventing, reducing and eliminating any form of violence, harassment, sexual harassment and abuse of authority in the workplace, defining procedures to prevent and address violence, harassment, sexual harassment and abuse of authority in the workplace, as well as making employees aware of easy and clear evidence of situations of such natures. Ensuring in this way that this Regulation serves as an increased guarantee for the fulfillment of the highest standards of ethical and professional behavior.

In the framework of the promotion of the quality of work-life, the Energy Regulatory Authority during this year has carried out programs and social-cultural activities such as "A day with children in the workplace" and the awareness campaign "Pink October".

Regarding the administration and management of Human Resources of ERE, during 2022, Law no. 9367 dated 07.04.2005 "On the prevention of conflict of interests in the exercise of public functions", amended by Law no. 86/2012 dated 18.09.2012, amended by Law no. 44/2014 dated 24.04.2014 and Law no. 9049, dated 10.04.2003 "On the declaration and audit of assets, financial obligations of elected officials and some public servants" amended by Law no. 85/2012 dated 18.09.2012, Law no. 45, dated 24.04.2014 as well as Law no. 42/2017 dated 04.06.2017. Throughout 2022, periodic/annual declarations of private interests have been completed by the officials who are subject to this obligation, according to the provided deadlines from the law. Regular communication was also maintained with High Inspectorate of Declaration and Audit of Assets and Conflict of Interests (ILDKPKI) in implementation of the notices submitted by this institution.

During this time, the training and qualifications of the ERE staff, which were conducted with ASPA (Albanian School of Public Administration), MEDREG, ERRA, USAID, ERRA and the Secretariat of Energy in Vienna, also continued.

12. ADMINISTRATION OF ERE FINANCIAL RESOURCES DURING 2022

ERE's financial resources and their administration throughout 2022, has been realized by correctly implementing the relevant legal and by-laws for the administration of ERE's finances, based on: (i) law no. 43/2015, dated 30.04.2015 "On Power Sector", as amended, (ii) law no. 9643, dated 20.11.2006 for "Public Procurement", as amended, (iii) Law no. 9228, dated 29.04.2004 "On accounting and financial statements", as well as (iv) Order no. 64 dated 22.07.2014 "On the announcement of improved national accounting standards and their mandatory implementation".

In every case, ERE has implemented the procedures and deadlines related to the execution of the procurements, in accordance with the procurement law and other by-laws.

As far as the monetary funds are concerned, they are provided in accordance with the respective laws of the power and natural gas sectors, and consist of license/modification/renewal application payments and adjustment payments that ERE has imposed for licensees.

Among the main expenditure items of ERE can be mentioned:

Staff payments, social and health insurance contributions, income taxes, for which our institution has settled all obligations and from the electronic system "Liabilities in real time" no debtors or fines result. This item foresees a possible increase which is related to several factors such as; (i) inflation, (ii) the forecast made public about the possibility of salary increases by the Government for the public administration, a fact that shall affect the salary level of ERE staff, (iii) the health insurance fund as well as voluntary retirement for a category of employees.

Publications for information of public opinion have been carried out pursuant to Law no. 43/2015, dated 30.4.2015 "On Power Sector" and Law no. 102/2015 "On Natural Gas Sector".

Payments for the repayment of service obligations such as water, electricity, telephone for which our institution is also not a debtor, expenses for services necessary for the smooth running of the work as well as depreciation of durable physical assets, etc.

Payments in order to fulfill commitments as a member country in a number of important international organizations of the power sector such as MEDREG, ERRA, IGU, CEER.

The possible forecast for expenses for renting offices to enable the realization with dignity of international activities where ERE occupies an important role, equal to the counterpart institutions, carrying out the work of ERE employees to realize and total independence as from licensees or stakeholders.

Investments to facilitate the control and monitoring procedures of the energy market, left and recommended by the performance and financial audits, expected to be carried out during 2022 which shall be completed and liquidated during 2023 and shall be covered from the surplus funds of the 2022 budget in accordance with the provisions of article 17 point 6 of the law on power sector.

The economic-financial activity of ERE for 2022, in accordance with the provisions of Article 17 of Law no. 43/2015, has been audited by a group of accounting experts registered and licensed for this activity based on Law no. 10091, dated 05.03.2009 "On the legal audit, the organization of the profession of the registered accounting expert and the approved accountant". In Appendix 1 below,

the corresponding report of the accounting expert related to the financial performance of ERE during 2023 is presented, as well as in Appendix 2 the performance report.

ERE budget was approved by Board decision no. 116/2023. This budget takes into consideration the requirements for the operation of ERE throughout 2023. In detail, this budget is presented in the table below.

BUDGET FOR 2023

No,	Name	Amount
I	OPERATING EXPENSES	348,174,000
	Staff salaries	182,575,000
	Expenses for Social and health insurance	23,500,000
	Depreciation Expenses	10,500,000
	Other Expenses	131,599,000
II	INVESTMENTS	56,220,000
	Monetary surplus *	78,016,000
	Total of the expected expenses for 2023	326,378,000

* Surplus funds in accordance with article 17 point 6 of the law on power sector have been transferred for 2023

ANNEX 1. AUDIT REPORT OF FINANCIAL STATEMENTS

RAPORT I AUDITUESEVE TE PAVARUR -ENTI RREGULLATOR I ENERGJISË (ERE)
[AUDITIM PËR PASQYRAT FINANCIARE TE VITIN E MBYLLUR ME 31 DHJETOR 2022]
[ADRESA: BLV. "BAJRAM CURRI", RRUGA "VIKTOR EFTIMIU" 1023; e-mail: erealb@ere.gov.al
TIRANË, SHQIPËRI

RAPORT I AUDITUESIT TE PAVARUR

Për: Z.Petrit Ahmeti

Kryetarit të Entit Rregullator të Energjisë

Blv. "Bajram Curri", Rruga "Viktor Eftimiu" 1023, Tiranë, Shqipëri

Raport mbi Auditimin e Pasqyrave Financiare të vitit 2022.**Opinion**

Ne kemi audituar pasqyrat financiare të Entit Rregullator të Energjisë-ERE, të cilat përfshijnë pasqyrën e pozicionit financiar më datën 31 Dhjetor 2022, pasqyrën e performancës financiare (burimeve dhe përdorimit), pasqyrën e ndryshimeve për fondet e akumuluar dhe pasqyrën e flukseve të parasë për vitin e mbyllur më datën 31 Dhjetor 2022, përfshirë shënimet shpjeguese për pasqyrat financiare, dhe një përmbledhje të politikave kontabël më të rëndësishme.

Sipas opinionit tonë, pasqyrat financiare bashkëlidhur paraqesin drejt, në të gjitha aspektet materiale, pozicionin financiar më datën 31 Dhjetor 2022, performancën financiare dhe flukset e parasë për vitin që mbyllet në këtë datë, në përputhje me "Standardet Kombëtare të Kontabilitetit (të përmirësuar)(SKKP), Ligjin nr.25/2018, datë 10.05.2018 "Për kontabilitetin dhe pasqyrat financiare" dhe Ligj nr. 43/2015 "Për sektorin e Energjisë Elektrike" [neni3 (pika 52 dhe 53); neni 11; neni 17]].

Baza për opinionin

Ne kryem auditimin në përputhje me Standardet Ndërkombëtare të Auditimit (SNA-të). Përgjegjësitë tona sipas këtyre standardeve janë përshkruar në mënyrë më të detajuar në seksionin e raportit ku jepen Përgjegjësitë e Audituesit për Pasqyrat Financiare. Ne jemi të pavarur nga Entiteti në përputhje me kërkesat etike që janë të zbatueshme për auditimin e pasqyrave financiare në Shqipëri, dhe kemi përmbushur përgjegjësitë e tjera etike në përputhje me këto kërkesa. Ne besojmë se evidenca e auditimit që kemi siguruar është e mjaftueshme dhe e përshtatshme për të dhënë një bazë për opinionin tonë.

Përgjegjësitë e Drejtimit në lidhje me Pasqyrat Financiare

Drejtimi është përgjegjës për përgatitjen dhe paraqitjen e drejtë të pasqyrave financiare në përputhje me SKKP dhe Ligjin nr.25/2018, datë 10.05.2018 "Për kontabilitetin dhe pasqyrat financiare" e Ligj nr. 43/2015 "Për sektorin e Energjisë Elektrike" (neni 17) dhe për ato kontrole të brendshme që drejtimi i gjykon të nevojshme për të bërë të mundur përgatitjen e pasqyrave financiare që nuk përmbajnë anomali materiale, qoftë për shkak të mashtrimit apo gabimit.

Në përgatitjen e pasqyrave financiare, drejtimi është përgjegjës për të vlerësuar aftësinë e Entitetit për të vazhduar sipas parimit të vijimësisë, duke dhënë informacion, nëse është e zbatueshme, për çështjet që kanë të bëjnë me vijimësinë dhe duke përdorur parimin kontabël të vijimësisë.

Ata që janë të ngarkuar me drejtimin janë përgjegjës për mbikqyrjen e procesit të raportimit financiar të Entitetit.

Përgjegjësitë e Audituesit për Auditimin e Pasqyrave Financiare

Objektivat tona të auditimit janë: të arrijmë një siguri të arsyeshme për faktin nëse pasqyrat financiare në tërësi kanë ose jo anomali materiale, për shkak të mashtrimit apo gabimit, dhe të lëshojmë një raport, i cili përfshin opinionin e audituesit. Siguria e arsyeshme megjithëse është një siguri e nivelit të lartë, nuk është një garancë që një auditim i kryer sipas SNA-ve do të identifikojë gjithmonë një anomali materiale kur ajo ekziston.

Raporti i audituesve të pavarur është i vlefshëm vetëm për pasqyrat financiare 2022 bashkëlidhur.

1

Anomalitë mund të vijnë si rezultat i gabimit ose mashtrimit dhe konsiderohen materiale nëse, individualisht ose të marra së bashku pritet, që në mënyrë të arsyeshme, të influencojnë vendimet ekonomike të përdoruesve, të marra bazuar në këto pasqyra financiare.

Një auditim i pasqyrave financiare në përputhje me SNA-të, kërkon që ne si auditues të ushtrijmë gjykimin profesional dhe të ruajmë skepticizmin profesional gjatë gjithë auditimit. Ne gjithashtu:

- Identifikojmë dhe vlerësojmë rreziqet e anomalisë materiale, qoftë për shkak të mashtrimit ose gabimit, hartojmë dhe kryejmë procedurat e auditimit në përgjigje të këtyre rreziqeve, dhe marrim evidencë auditimi që është e mjaftueshme dhe e përshtatshme për të siguruar një bazë për opinionin tonë. Rreziku i moszbulimit të një anomalie materiale si rezultat i mashtrimit është më i lartë se rreziku i moszbulimit si rezultat i gabimit, sepse mashtrimi mund të përfshijë marrëveshje të fshehta, falsifikime, përjashtime të qëllimshme, informacione të deformuara, anashkalime të kontroleve të brendshme.
- Sigurojmë një njohje të kontrollit të brendshëm që ka të bëjë me auditimin, me qëllim që të përcaktojmë procedurat e auditimit që janë të përshtatshme sipas rrethanave, por jo për qëllime të shprehjes së një opinioni mbi efikasitetin e kontrollit të brendshëm.
- Vlerësojmë përshtatshmërinë e politikave kontabël të përdorura dhe arsyeshmërinë e çmuarjeve kontabël dhe të shpjegimeve përkatëse të bëra nga drejtimi.
- Nxjerrim një konkluzion në lidhje me përshtatshmërinë e përdorimit të bazës kontabël të vijmësisë, dhe bazuar në evidencën e auditimit të marrë, nëse ka një pasiguri materiale në lidhje me ngjarjet ose kushtet, e cila mund të hedhë dyshime të mëdha për aftësinë e për të vijuar veprimtarinë. Nëse ne arrijmë në përfundimin që ka një pasiguri ne duhet të tërheqim vëmendjen në raportin e audituesit në lidhje me shpjegimet e dhëna në pasqyrat financiare, ose nëse këto shpjegime janë të papërshtatshme, duhet të modifikojmë opinionin tonë. Konkluzionet tona bazohen në evidencën e auditimit të marrë deri në datën e raportit tonë. Megjithatë, ngjarje ose kushte të ardhshme mund të bëjnë që Entiteti të ndërpresë veprimtarinë.
- Vlerësojmë paraqitjen e përgjithshme, strukturën dhe përmbajtjen e pasqyrave financiare, përfshirë informacionet shpjeguese të dhëna, dhe nëse pasqyrat financiare paraqesin transaksionet dhe ngjarjet në to në një mënyrë që arrin paraqitjen e drejtë.

Ne komunikojmë me personat të ngarkuar për qeverisjen e institucionit, përveç se çështjeve të tjera, edhe objektin dhe kohën e planifikuar të auditimit, gjetjet kryesore të auditimit, përfshirë çdo mangësi relevante në kontrollin e brendshëm të identifikuar gjatë auditimit tonë.

Auditues Ligjor

Ermir Veipi

Partner Anëtarshimi
CONSULTING PARTNERS
Parti A.B.R.K.
M22123012V
CONSULTING PARTNERS sh.p.k.
License: Nr.261; 27.08.2019
Adresa: Komuna e Parisit, Pallati Niku
Konstruktion, Kati 7, Ap. 61
consultingpartnersshpk@gmail.com

Auditues Ligjor

Kondor Çeka

License: Nr. 480; 16.09.2021
Adresa: Nj.8, nr.2, Rruga Luigj Gurakuqi,
P.18, Hyrja 4, Ap.21, Tirane
e-mail: dori.ceka@viar.al

Tiranë më 23/03/2023

Raporti i audituesve të pavarur është i vlefshme vetëm për pasqyrat financiare 2022 bashkënlidhur.

2

**PASQYRAT FINANCIARE PËR VITIN E MBYLLUR MË 31 DHJETOR 2022
ENTI RREGULLATOR I ENERGJISË (ERE)**

NIPT: K517170241
Adresa: Blv. "Bajram Curri",
Rruga "Viktor Eftimiu" 1023
e-mail: erealb@ere.gov.al
Tiranë, Shqipëri

Tiranë, më 16/03/2023

Enti Rregullator i Energjisë -ERE
 Shënime për pasqyrat financiare për vitin e mbyllur 31 Dhjetor 2022
 (Të gjitha shumat janë në LEK, nëse nuk shprehet ndryshe).

Përmbajtja

Pasqyra e pozicionit financiar.....	1
Pasqyra Performancës (Burimet dhe Përdorimet).....	2
Pasqyra e ndryshimit të Fondeve.....	3
Pasqyra e flukseve monetare.....	4
Shënimet shpjeguese të pasqyrave financiare.....	5
A. Informacion i përgjithshëm.....	5
B. Parimet bazë për përgatitjen e pasqyrave financiare.....	5
C. Politikat kontabile.....	6
1. Transaksionet në monedhë të huaj.....	6
2. Instrumentat financiare.....	6
3. Inventaret.....	8
4. Aktivët Afagjate Materiale (AAM-t).....	8
5. Qiratë.....	9
6. Transaksionet me palët e lidhura.....	9
7. Grantet qeveritare.....	9
8. Të Ardhurat dhe shpenzimet.....	10
9. Përfitimet e punonjësve.....	10
10. Angazhimet dhe detyrime të kushtëzuara.....	10
11. Korrigjimi i gabimeve.....	10
12. Ngjarje pas mbylljes së pasqyrave financiare.....	10
D. Shënimet për Pozicionet Financiare.....	10
1. Mjetet monetare.....	10
2. Të arkëtueshme.....	11
3. Inventarët.....	11
4. Aktivët Afagjate Materiale (AAM) dhe Jo Materiale (AAJM).....	11
5. Të pagueshme për aktivitetin e shfrytëzimit.....	12
6. Të ardhurat nga aktiviteti.....	13
7. Shpenzimet për personelin.....	13
8. Shpenzimet për amortizimin dhe zhvlerësimi.....	13
9. Shpenzime të tjera shfrytëzimi.....	13
10. Shpenzime financiare.....	13
11. Rritje/(Rënie) Neto e Fondeve.....	14
12. Teprica e Fondeve më 31.12.2022.....	14
13. Palet e lidhura.....	14
14. Angazhime dhe detyrime të kushtëzuara.....	14
15. Kontrollat tatimore.....	14
16. Ngjarje pas datës së bilancit.....	14

Enti Rregullator i Energjitikë - ERE
Shënime për pasqyrat financiare për vitin e mbyllur 31 Dhjetor 2022
(Të gjitha shumat janë në LEK, nëse nuk shprehet ndryshe).

Pasqyra e pozicionit financiar

AKTIVET	Shënime	31 dhjetor 2022	31 dhjetor 2021
Aktive afatshkurtra			
Mjete monetare			
Investime	1	89.624.668	56.240.725
Te drejta te arketueshme			
Nga aktiviteti i shfrytezimit		-	-
Nga njesite ekonomike ku ka interesa pjesmarrese	2	7.391.079	11.426.152
Te tjera		-	-
Kapital i nenshkuar i papaguar		1.856.928	436.857
Inventaret			
Lende e pare dhe materiale te konsumueshme	3	4.941.492	3.107.381
Shpenzime te shtyra			
Te arketueshme nga te ardhura te konstatuara		-	-
Totali i aktiveve afatshkurtra		103.814.167	71.211.116
Aktive afatgjate			
Aktive financiare			
Aktive materiale			
Toka dhe ndertesa		-	-
Makineri e Pajise		-	-
Mjete Transporti	4	4.752.931	5.941.168
Pajise Zyresh	4	6.334.654	7.031.192
Te tjera pajise dhe Informatike	4	35.254.563	39.069.624
Aktivitet biologjike			
Aktive jo materiale			
Koncensione, patenta, licenca, makra tregtare, te drejta dhe aktive te naqashme	4	52.894.864	63.410.106
Emri i mire		-	-
Parapagime per AAJM		-	-
Aktivitet tatimore te shtyra			
Totali i aktiveve afatgjate		99.237.012	115.452.089
Totali i Aktiveve		203.051.178	186.663.205
DETYRIMET DHE KAPITALI			
Detyrime afatshkurtra			
Detyrime ndaj institucioneve te kredise			
Te pagueshme per aktivitetin e shfrytezimit	5	779.083	1.169.444
Deftesa te pagueshme		-	-
Te pagueshme ndaj njesive ekonomike brenda grupit *		-	-
Te pagueshme ndaj njesive ekonomike ku ka interesa		-	-
Te pagueshme ndaj punonjesve dhe sigurimeve	5	3.018.559	2.005.067
Te pagueshme per detyrime tatimore	5	2.926.015	2.964.373
Te tjera te pagueshme	5	60.517	67.169
Te pagueshme per shpenzime te konstatuara			
Te ardhura te shtyra		-	-
Provizione		-	-
Totali i detyrimeve afatshkurtra		6.784.174	6.206.053
Detyrime afatgjate			
Totali i detyrimeve afatgjate			
Detyrime Totale		6.784.174	6.206.053
Fondet të akumuluar - ERE			
Rritje/Rënie fondesh gjatë vitit	11	180.457.152	166.470.859
Shuma		15.809.852	13.986.292
Totali i Detyrimeve dhe i Fondeve		203.051.178	186.663.205

Hartuesi i Pasqyrave Financiare
Aferdita Bushi

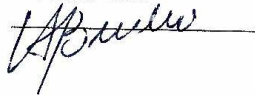

Kryetar
Peirit Ahmeti



Enti Rregullator i Energjitë -ERE
Shënime për pasqyrat financiare për vitin e mbyllur 31 Dhjetor 2022
(Të gjitha shumat janë në LEK, nëse nuk shprehet ndryshe).

Pasqyra Performancës (Burimet dhe Përdorimet)

		Viti 2022	Viti 2021
Te ardhura te shfrytezimit			
Te ardhurat nga Faturimi i Operatoreve	6	209.781.572	207.671.534
Te ardhurat nga Licensimi	6	20.330.710	10.796.150
Te tjera te ardhura nga organizma mbulim shpenzimesh		-	-
Te ardhura te tjera te shfrytezimit		-	-
Lenda e pare dhe materiale te konsumeshme		-	-
Lenda e pare dhe materiale te konsumeshme		-	-
Te tjera shpenzime		-	-
Shpenzime te personelit			
Paga dhe shperblime	7	(139.337.160)	(149.503.066)
Shpenzime te sigurimeve shoqerore/shendetsore	7	(16.520.843)	(16.129.562)
Shpenzimet per pensionet		-	-
Zhvleresimi i aktiveve atafgjata materiale			
Shpenzime konsumi dhe amortizimi	8	(23.041.112)	(14.389.798)
Shpenzime te tjera shfrytezimi	9	(36.067.601)	(24.411.287)
Te ardhura te tjera			
Te ardhura nga njesite ekonomike brenda grupi*		-	-
Te ardhura nga njesite ekonomike ku ka interesa		-	-
Te ardhura nga investimet dhe huate e tjera ne njesi		-	-
Te ardhura nga investimet dhe huate e tjera ne njesi		-	-
Interesa te arketueshem dhe te ardhura te tjera te		-	-
Interesa te arketueshem dhe te ardhura te tjera te		-	-
Zhvleresim i aktiveve financiare dhe investimeve			
Shpenzime financiare			
Shpenzime interesi dhe shpenzime te ngjashme		(82.668)	(84.594)
Shpenzime interesi dhe shpenzime te ngjashme per tu		-	-
Shpenzime te tjera financiare	10	746.954	36.916
Pjesa e fitimit/(humbjes) financiare nga pjesmarrjet			
Fitimi/(humbja) para tatimit	11	15.809.852	13.986.292
Tatimi mbi fitimin			
Tatimi mbi fitimin e periudhes		-	-
Tatim fitimi i shtyre			
Pjesa e tatim fitimit te pjesemarrjeve		-	-
Rritje/(Rënie) Neto e Fondeve		15.809.852	13.986.292

Hartuesi i Pasqyrave Financiare

Aferdita Bushi

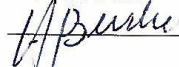

Kryetar

Petrit Ahmeti



Enti Rregullator i Energjisë -ERE
 Shënime për pasqyrat financiare për vitin e mbylltur 31 Dhjetor 2022
 (Të gjitha shumat janë në LEK, nëse nuk shprehet ndryshe).

Pasqyra e ndryshimit të Fondeve

	Fondet Të Akumuluar - ERE	Rritje/Rënie fondesh gjatë vitit	Totali
Pozicioni financiar ne fillim 01.01.2021	106.054.620	60.416.239	166.470.859
Efekti i ndryshimeve ne politikat kontabile			-
Pozicioni financiar i rideklaruar ne fillim	106.054.620	60.416.239	166.470.859
Rezultati viti paraardhes	60.416.239	(60.416.239)	-
Rritje/Rënie fondesh gjatë vitit		13.986.292	13.986.292
Pozicioni financiar ne fund 31.12.2021	166.470.859	13.986.292	180.457.152
Rezultati viti paraardhes	13.986.292	(13.986.292)	-
Rritje/Rënie fondesh gjatë vitit		15.809.852	15.809.852
Pozicioni financiar ne fund 31.12.2022	180.457.152	15.809.852	196.267.004



Kryetari
 Petrit Ahmeti

Hartuesi i Pasqyrave Financiare

Aferdita Bushi

Enti Rregullator i Energjisë - ERE
Shënime për pasqyrat financiare për vitin e mbyllur 31 Dhjetor 2022
(Të gjitha shumat janë në LEK, nëse nuk shprehet ndryshe).

Pasqyra e flukseve monetare

	31 dhjetor 2022	31 dhjetor 2021
Fluksi mjeteve monetare nga/perdorur ne aktivitetin e shfrytezimit:		
Fitimi/(Humbja) e periudhes	15.809.852	13.986.292
<i>Rregullime per shpenzimet jo-monetare:</i>		
Shpenzime konsumi dhe amortizimi	23.041.112	14.389.798
Renie/(Rritje) ne te drejtat e arketueshme dhe te tjera	2.615.002	15.309.410
Renie/(Rritje) ne inventar	- 1.834.111	- 450.135
Rritje/(Renie) ne detyrime te pagueshme	578.121	- 18.168.648
Rritje/(Renie) ne detyrime per punonjesit		
Mjete monetare neto nga/ perdorur ne aktivitetin e shfrytezimit	40.209.977	25.066.717
Fluksi i mjeteve monetare nga/ perdorur ne aktivitetin e investimit		
Pagesa per blerjen e aktiveve afatgjata materiale	- 6.826.035	83.276.191
Arketime nga shitja e aktiveve afatgjata materiale		
Mjete monetare neto nga/perdorur ne aktivitetin e investimit	- 6.826.035	- 83.276.191
Mjete monetare neto nga/perdorur ne aktivitetin e financimit	-	-
Rritje/(renie) neto ne mjetet monetare dhe ekuivalente me to	33.383.942	- 58.209.473
Mjete monetare dhe ekuivalente me to ne fillim	56.240.726	114.450.199
Efekti i luhatjeve te kurseve te kembimit te mjeteve monetare	-	-
Mjete monetare dhe ekuivalente me to ne fund	89.624.668	56.240.726

Hartuesi i Pasqyrave Financiare
Aferdita Bushi

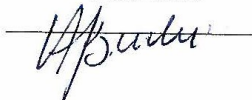

Kryetar
Petrit Ahmeti



**Entit Rregullator të Energjisë (ERE)
Letra e menaxhimit për periudhën
Janar-Dhjetor 2022**

Të nderuar zotërinj,

Grupi ynë i auditimit ka ekzaminuar kontrollin e brendshëm dhe pasqyrat financiare të Entit Rregullator të Energjisë. Sistemet e kontabilitetit dhe ato të kontrollit janë verifikuar deri në masën e nevojshme që lejon përcaktimi i procedurave të auditimit për raportim në pasqyrat financiare.

Gjatë auditimit kemi evidentuar disa problematika për të cilat kemi bashkëngjitur rekomandimet tona, në mënyrë për të ndihmuar në përmirësimin e proceseve dhe për të arritur efikasësi operationale.

Komentet dhe rekomandimet e bashkëngjitura kanë si qëllim të vetëm informimin dhe përdorimin e drejtuesve të institucionit dhe palëve të interesuara.

Faleminderit juve dhe stafit tuaj për bashkëpunimin dhe ndihmën e vazhdueshme gjatë procesit të auditimit.

Auditues Ligjor (Partner Angazhimi)

Ermir Veipi

CONSULTING PARTNERS
SH.PK.
License: Nr.261/27.08.2012
Adresa: Komuna e Prishtinës, Bllat Niku
Konstruksion, Kati 7, Ap. 61
prishtine.albania@consultingpartnersshpk@gmail.com

Auditues Ligjor

Kondor Çeka

License: Nr. 480; 16.09.2021
Adresa: Nr.8, nr.2, Rruga Luigj
Gurakuqi, P.18, Hyrja 4, Ap.21, Tirane
e-mail: dori.ceka@viar.al

Tiranë, më 23.03.2023

Aneksi 1. Letra e menaxhimit

Gjeje	Rekomandime	Komentet e drejtimii
<p>Përgatitja e Pasqyrave Financiare</p> <p>Pasqyrat financiare të datës 31 dhjetor 2022 janë përgatitur në një platformë excel të cilat në gjykim e audituesit ligjor mund të mbarin pasiguri mbi interpretimin kronologjik dhe logjik për të kuptuar skemat kontabile të aktivitetit. Për rrjedhojë, përgatitja në format excel mbart një pasiguri materiale që mund të supozojnë dyshime për gabime rrezore.</p> <p>Audituesit Ligjor konstatojnë se ERE nuk ka një metodologji të miratuar për mënyrën e trajtimit të llogarive të arkëtueshme të cilat arkoohen me vonë ose nuk arrijnë të arkëtohen. Më dhjetor 2022 shuma e debitorëve të parkëtuar mbi 360 ditë është 5,239 mijë lekë.</p>	<p>Entiteti ka prokuruar software Financa5 për mbajtjen e kontabilitetit. Informacioni kontabël gjendet më 31,12,2022 duhet çelur në këtë software, dhe gjithë transaksionet dhe veprimet kontabël për vitin 2023 të regjistrohen në të, duke rritur sigurinë dhe cilësinë e sistemit kontabël të Entitetit.</p> <p>Në fund të çdo periudhe raportimi, Entiteti në bazë të një metodologjie duhet të vlerësojë nëse ka një evidencë objektive të zhvlerësimit të ndonjë aktivi financiar që matet me kosto ose me kosto të amortizuar dhe nëse ekziston një evidencë objektive të zhvlerësimit, Entiteti duhet të njohë menjëherë një humbje nga zhvlerësimi në fitim ose humbje.</p>	<p>Marrim në konsideratë rekomandimin e audituesve.</p> <p>Marrim në konsideratë rekomandimin e audituesve.</p>
<p>Struktura e Teknologjise e Informacionit (IT)</p> <p>Entiteti nuk ka në strukturë staf eficient për mbulimin e sistemit të IT.</p>	<p>Entiteti duhet të investojë për funksionimin e një strukture të IT-e efektive për aktivitetin e tij në mënyrë eficiente.</p>	<p>Marrim në konsideratë rekomandimin e audituesve.</p>

Aneks 1. Letra e menaxhimit

Shojcë

Kërkesat e ligjit nr. 43/2015, Nenin 11 pika 7

Audituesit kanë konstatuar se ERE ka përcaktuar pagën dhe strukturën në përputhje me keto kërkesa. Me anë të vendimit nr. 46, nr. 47 dhe nr. 61 të vitit 2016 janë miratuar Rregullorja për trajtimet financiare bazë të punonjësve të ERE, trajtimi financiar bazë me karakter të përkohshëm si edhe përcaktimi i nivelit të trajtimit financiar bazë për kushtet e tregut të punës.

Përgjegjësia e Drejtimit për Objektivat dhe Kufizimet e Sistemit të Kontrollit të Brendshëm

Komentet e mëposhtme u referohen përgjegjësive së Drejtimit për sistemin e brendshëm të kontrolleve, ku objektivat dhe kufizimet e qenësishme në sistemin e kontrollit të brendshëm janë marrë nga Standardet Ndërkombëtare të Auditimit të Federatës Ndërkombëtare të Kontabiliteteve.

Përgjegjësia e Drejtimit

Drejtimi është përgjegjës për vendosjen dhe mirëmbajtjen e sistemit të kontrolleve të brendshme. Në përmbushjen e kësaj përgjegjësie, Drejtimi duhet të vlerësojë përfitimet dhe kostot e pritura përkatëse të politikave dhe procedurave për kontrollet e brendshme.

Objektivat

Objektivat e sistemit të kontrollit të brendshëm janë që të japin siguri drejtimi, sa më shumë të jetë e mundur, që asetet të jenë të mbrojtura nga perdorimi i paautorizuar ose keqpërdorimi, dhe se transaksionet janë ekzekutuar në përputhje me politikat e drejtimit dhe të regjistruhen saktë, në mënyrë që të mundësohet përgatitja në kohë e informacionit të besueshëm financiar në përputhje me parimet e zbatueshme të kontabilitetit.

Kufizimet

Për shkak të kufizimeve të qenësishme në çdo sistem të kontrollit të brendshëm, gabimet apo parregullsitë, mund të ndodhin dhe të mbeten të pazbuluara. Gjithashtu, parashikimi i çdo vlerësimi të sistemit të kontrollit të brendshëm për periudhat e ardhshme është subjekt i rrezikut që politikat dhe procedurat mund të bëhen të papërshtatshme për shkak të ndryshimeve të kushteve ose efektiviteti i hartimit dhe i zbatimit të politikave dhe procedurave mund të përkeqësohet.

ANNEX 2. PERFORMANCE REPORT



Adresa: Rr. "L.Gurakuqj" Ndëtesa.18; H.4; K.6; Ap.21,
Tiranë, Albania
T: 04 56 28 875
Web: www.viar.al



Str. Margarita Tutulani,
Palazzo Viridario 1, 1-st floor,
Tirana, Albania
T: +355 4 223 2726
www.nexia.al

Letra për Drejtimin -Raporti Vjetor 2022

Enti Rregullator i Energjisë (ERE)

Tiranë, më 30 Mars 2023

*Enti Rregullator i Energjisë (ERE) Letra për Drejtimin – Raporti Vjetor 2022***Përmbajtja**

LETET REKOMANDIMI E PROFESIONISTËVE TË PAVARUR	2
REKOMANDIME TË AUDITUESVE TË PAVARUR PËR VLERËSIMIN E PËRFORMANCËS 2022	3
1. Automatizimi i mënyrës së raportimit të të licensuarve pranë ERE-s	3
2. Mbivendosje funksionesh në strukturën organizative të ERE	4
REKOMANDIMET PËR VITIN 2022 SIPAS REZOLUTËS “PËR VLERËSIMIN E VEPRIMTARISË SË ERE PËR VITIN 2021”	5
1. Nxitja e investimeve për prodhimin e energjise elektrike nga burimet e rinovueshme	5
2. Mbrojtja e interesave të konsumatoreve nga çmimet e larta të energjisë	6
3. Metodologjia e çmimit të blerjes së energjisë elektrike të prodhuar nga vetëprodhuesit	7
4. Nxitja e vënies në funksion e bursës së energjisë elektrike	8
5. Ndihmesë në ndërtimin e rrjetit të transmetimit dhe shpërndarjes së gazit natyror	9
6. Përditësimi i faqes zyrtare në internet të linkut/grafika “Bëj një ankesë” në ERE	10
7. Vlerësimi nga ERE i Performancës së Shërbimit ndaj klientit	11
8. Mbrojtja e të drejtave të konsumatoreve të energjise elektrike	12
9. Sensibilizimi i konsumatorit për përdorimin me eficiencë të energjisë elektrike	13
10. Ofertimi i çmimeve nëpërmjet një platforme të furnizuesve të licensuar	14
11. Instalimi gradual i matësve inteligjentë, bazuar në një analize kosto-përfitim	15
STATUSI I ÇËSHTJEVE SIPAS LETRËS SË DREJTIMIT TË VITIT 2021	16
1. Zvogëlimi i barrierave rregullatore	16
STATUSI I ÇËSHTJEVE SIPAS LETRËS SË DREJTIMIT TË VITIT 2020	17
1. Pronësia e kabinave elektrike	17
2. Ankesat konsumatore për periudhën 2008-2011	18
3. Sistemet informative dhe rreziku i sulmit kibernetik	19
REKOMANDIME TË TJERA	20

*Enti Rregullator i Energjisë (ERE) Letra për Drejtimin – Raporti Vjetor 2022***LETËR REKOMANDIMI E PROFESIONISTËVE TË PAVARUR****Drejtuar: Kryetarit dhe Bordit të Entit Rregullator të Energjisë (ERE)**

Gjatë planifikimit dhe kryerjes së procedurave tona për të shqyrtuar informacionin jo-financiar të paraqitur në Raportin Vjetor për vitin e mbyllur më 31 Dhjetor 2022 ("të dhëna të zgjedhura"), me qëllim dhënien e sigurisë së kufizuar ne morëm në konsideratë strukturën e kontrollit të brendshëm të Entit në mënyrë që të përcaktonim procedurat e Angazhimit për Dhënien e Sigurisë planifikuar dhe kryer në përputhje me Standardin Ndërkombëtar SNAS 3000, "Angazhimet e Dhënies së Sigurisë ("SNAS 3000") që ndryshojnë nga Auditimet ose Rishikimet e Informacioneve Financiare Historike", me qëllim që të jepnim një opinion për dhënie sigurie të nivelit të kufizuar për:

- *Verifikimin e informacioneve shpjeguese cilësore dhe sasore të paraqitura me strukturat organizative të ERE-s si dhe në Raportin Vjetor 2022 në mënyrë specifike për gjendjen në sektorin e energjisë elektrike dhe të gazit natyror, në krahasim me kriteret e zbatueshme ("Kriteret e Përformances", të ilustruara në Raportin Vjetor), mbështetur në Ligjin nr. 43/2015, "Për Sektorin e Energjisë Elektrike", i ndryshuar dhe Ligjin Nr. 102/2015 "Për Sektorin e Gazit Natyror", i ndryshuar.*

Ne kemi raportuar vetëm ato çështje që kanë qenë në vëmendjen tonë gjatë procesit të këtij angazhimi duke përfshirë dhe vlerësimin e sistemit të kontrollit të brendshëm deri në masën e nevojshme për të përcaktuar natyrën, kohën dhe shtrirjen e procedurave të tjera. Puna jonë nuk ka pasur si qëllim kryesor zbulimin e dobësive, zbulimin e mashtrimeve ose parregullsisë të ngjashme dhe si rrjedhim nuk duhet të merret si bazë që asnjë dobësi tjetër nuk ekziston.

Çështjet e ngritura në këtë letër janë vetëm ato të cilat kanë qenë në vëmendjen tonë gjatë këtij angazhimi dhe që ne besojmë se duhet të sillen në vëmendjen tuaj. Nuk përfshihen të gjitha çështjet e mundshme, dhe në veçanti, ne nuk mund të jemi përgjegjës për raportimin e të gjitha rreziqeve në biznesin tuaj ose të gjitha dobësive në kontrollit e brendshëm. Rrjedhimisht, komentet në këtë letër i referohen vetëm çështjeve, të cilat kanë ardhur në vëmendjen tonë gjatë rrjedhës normale së punës sonë dhe nuk paraqet të gjitha përmirësimet e mundshme, të cilat mund të identifikohen nga një shqyrtim i veçantë.

Ky raport lëshohet vetëm për qëllim informativ dhe për përdorim nga Drejtimi dhe Bordi i ERE, e për rrjedhojë nuk mund të përdoret nga persona të tjerë.

Ne duam të shprehim vlerësimin tonë ndaj drejtimit dhe punonjësve për ndihmën dhe bashkëpunimin përgjatë procesit.

Nexia-AL sh.p.k
Orjana Kalaja

Auditues Ligjor
License Nr.284



VIAR-Consulting sh.p.k.
Fatime Alliu
Auditues Ligjor
License Nr.166



Tiranë, më 30/03/2023

Enti Rregullator i Energjisë (ERE) Letra për Drejtimin – Raporti Vjetor 2022

REKOMANDIME TË AUDITUESVE TË PAVARUR PËR VLERËSIMIN E PËRFORMANCËS 2022

1. Automatizimi i mënyrës së raportimit të të licensuarve pranë ERE-s

Çështje

Gjatë kryerjes së procedurave tona për të shqyrtuar informacionin jo-financiar të paraqitur në Raportin Vjetor për vitin e mbyllur më 31 Dhjetor 2022, ne vumë re që përpunimi i informacionit në lidhje me Bilancin Energjistik kryhej në formate excel në departamentin e monitorimit në bazë të raportimeve të kryar nga operatorët e licensuar.

Këto formate raportimi ishin të ndryshme në varësi të secilit operator, nga ku ERE, konsolidon të dhënat më pas në mënyrë manuale, gjë që kërkon kohë dhe mund të jetë subjekt i gabimeve manuale.

Impakti

ERE, përgatit Raportin Vjetor, mbështetur në Ligjin nr. 43/2015, "Për Sektorin e Energjisë Elektrike", i ndryshuar dhe Ligjin Nr. 102/2015 "Për Sektorin e Gazit Natyror", i ndryshuar, megjithatë, nuk ka implementuar një sistem informatik gjithëpërfshires për konsolidimin e informacionit nga entitetet raportuese pa patur nevojën e ndërhyrjeve manuale.

Rekomandimi

Të krijohet një tool në excel monitorues dhe raportues i cili të unifikojë mënyrën e raportimit të entiteteve të licensuar nga ERE. Në këtë tool çdo operator i sektorit energjistik duhet të ketë mundësinë të raportojë dhe dokumentojë në mënyrë të standardizuar bilancin e tij energjistik, gjë që duhet të lehtësojë edhe procesin e konsolidimit të të dhënave në mënyrë të standardizuar. Gjithashtu është evidentuar pamundësia e garantimit të një shërbimi cilesor që lidhen me inspektimet e të licensuarve ku përfshihen realizimet e inspektimeve të thelluara rastësore.

Komentet e Drejtimit

ERE ka parashikuar në Buxhetin e vitit 2022 zërin për investime në automatizimin e mënyrës së raportimit të pjesëmarrësve të tregut në ERE. Aktualisht kontrata për realizimin e këtij investimi është në proces implementimi dhe pritet të përfundojë brenda muajit Qershor 2023. Gjithashtu ERE vlerëson të nevojshme parashikimet e duhura në Buxhet për vitin 2023 ku të sigurohen paisjet e nevojshme për të realizuar inspektimet e thelluara rastësore.

*Enti Rregullator i Energjisë (ERE) Letra për Drejtimin – Raporti Vjetor 2022***2. Mbivendosje funksionesh në strukturën organizative të ERE****Çështje**

Gjatë kryerjes së procedurave tona për të shqyrtuar informacionin jo-financiar të paraqitur në Raportin Vjetor për vitin e mbyllur më 31 Dhjetor 2022, ne vumë re që disa funksione monitorimi ndaj operatorëve të licensuar pranë ERE janë të përsëritura dhe të mbivendosura përkatesisht pranë Departamentit të Monitorimit të Tregut dhe Inspektiveve, si edhe pranë Departamentit të Licensimit, Autorizimeve dhe Mbikëqyrjes.

Gjithashtu ne vumë re se sipas kërkesave të Ligjit nr. 43/2015, Nenin 11 pika 7 ERE ka përcaktuar pagën dhe strukturën në përputhje me keto kërkesa. Kështu me anë të vendimit nr. 46, nr. 47 dhe nr. 61 të vitit 2016 janë miratuar Rregullorja për trajtimet financiare bazë të punonjësve të ERE, trajtimi financiar bazë me karakter të përkohshëm si edhe përcaktimi i nivelit të trajtimit financiar bazë për kushtet e tregut të punës.

Impakti

Mbivendosja e funksioneve dhe përsëritja e tyre në disa departamente, bën që të rriten kostot operacionale si edhe përsëritje procedurash për subjektet e licensuara duke shtuar burokracitë dhe kohën e procesimit të informacioneve.

Rekomandimi

Të rishikohet struktura organizative e ERE si edhe përkrahimi i roleve të secilit departament, duke parë mundësinë që funksionet mos të jenë të përsëritura por të rritet koordinimi midis departamenteve në mënyrë që të kontribuojë në rritjen e efikasitetit në kryerjen e proceseve të ndryshme administrative. Po ashtu vërehet që ambientet e punës në ERE nuk ofrojnë kushte optimale për punonjësit dhe për shërbimet ndaj konsumatorëve, të licensuarve si dhe pozicionit që ERE zë në sektorin e Energjisë brenda dhe jashtë vendit.

Duhet vlerësuar mundësia e sigurimit të ambienteve të përshtatshme për kryerjen e funksioneve të dhe shërbimeve të ERE sipas standarteve.

Komentet e Drejtimit

ERE në zbatim të rekomandimit të lëna për vitin 2021, ka realizuar analizën përkatëse lidhur me ndarjen e funksioneve të drejtorive respektivisht DLAM, DMTI dhe DMKPS. Nga analiza rezultoi se detyrat e këtyre drejtorive janë të ndara sikurse vijon:

DLAM kryesisht realizon mbikëqyrjen e kushteve të licensës, në të njëjtën kohë DMTI realizon procesin e monitorimit të tregut me shumicë të energjisë elektrike ku rol të vecantë kanë transaksionet në tregun e energjisë elektrike, DMKPS realizon mbikëqyrjen e standarteve të cilësisë së furnizimit me energji elektrike në tregun me pakicë të energjisë.

ERE në vijim, në përputhje me dinamikën e zhvillimit të tregut të energjisë, rekomandimeve të vitit 2021 të auditit si dhe eksperiencave të institucioneve homologe ka përgatitur rishikimin e strukturës organizative.

Në këtë kuadër të rishikohet dhe të përshtatet rregulloret e funksionimit të ERE në përputhje me strukturën e përgatitur.

Bordi i ERE në përputhje me Ligjin nr.43/2015, ka përcaktuar pagën dhe strukturën në përputhje me Nenin 11 pika 7 të ligjit. Për më tepër Bordi ka marrë parasysh edhe kushtet e tregut dhe nivelin e pagave të subjekteve që kontrollohen nga ERE në procesin e përcaktimit të tyre për punonjësit e saj.

Enti Rregullator i Energjisë (ERE) Letra për Drejtimin – Raporti Vjetor 2022

REKOMNADIMET PËR VITIN 2022 SIPAS REZOLUTËS “PËR VLERËSIMIN E VEPRIMTARISË SË ERE PËR VITIN 2021”

1. Nxitja e investimeve për prodhimin e energjise elektrike nga burimet e rinovueshme

Çështje

ERE në bashkepunim me Ministrinë e Infrastruktures dhe Energjisë dhe aktoret e tjerë në fushën e energjisë të luajë një rol aktiv në hartimin e një plani konkret për të bërë të mundur lehtësimin e barrierave, promovimin, si dhe incentivimin e impianteve të veteprodhimit të energjisë nga burime të rinovueshme (veçanërisht nga dielli dhe era) si për bizneset e mëdha prodhuese, që kanë një konsum energjie më të lartë, ashtu edhe për familjaret, Investimi në impiante të veteprodhimit të energjisë nga burime të rinovueshme, duke pasur parasysh edhe situatën dhe zhvillimet më të fundit në tregun global të energjisë, ndikon nga njera anë në uljen e shpenzimeve të energjisë për bizneset prodhuese dhe familjaret dhe nga ana tjetër në uljen e konsumit të energjisë nga rrjeti dhe diversifikimin e prodhimit të energjisë.

Impakti

Nxitja e investimeve të burimeve të vogla të rinovueshme nepërmjet krijimit të një terreni ligjor optimal, do ishte mjaft impaktuese për diversifikimin e prodhimit të energjisë por edhe në uljen e shpenzimeve konsumatore me qëllim garantimin e furnizimit me energji elektrike.

Rekomandimi

Materializimi i informacioneve të marra nga korrespondecat me OSSH sh.a dhe MIE, në raporte, relacione, apo akte konkrete me qëllim nxitjen e investimeve.

Komentet e Drejtimit

Për plotësimin e këtij rekomandimi ERE ka zhvilluar një sërë korrespondencash me OSSH sh.a. për të kërkuar informacion për të krijuar një panoramë më të gjerë në lidhje me situatën dhe potencialin e burimeve të vogla të rinovueshme si ato fotovoltaike.

ERE ka kërkuar informacion subjekteve tregëtarë, lidhur me shkallën e interesit të shfaqur gjatë vitit 2022 nga konsumatorët e energjisë elektrike për instalimin e paneleve fotovoltaike për kategorinë e konsumatorëve familjarë dhe jofamiljarë si dhe një vlerësim nga ana e subjekteve tregëtarë në lidhje me masën e kthimit të investimit të kryer për këto impiante.

ERE ka qene pjese aktive e bashkepunimit me MIE ne draftimin e Ligjit. Duke qene se aktualisht ligji per burimet e rinovueshme eshte miratuar, ERE do te angazhohet ne nxjerrjen e akteve regullatore qe dalin si detyrim i ketij ligji.

*Enti Rregullator i Energjisë (ERE) Letra për Drejtimin – Raporti Vjetor 2022***2. Mbrojtja e interesave të konsumatoreve nga çmimet e larta të energjisë****Çështje**

Duke pasur parasysh çmimet e larta të energjisë dhe zhvillimet më të fundit në tregun global të energjisë, në bashkëpunim me të gjithë aktoret në këtë fushë ERE duhet japë kontributin e saj dhe ekspertizën teknike për të bërë më mundur forcimin e mekanizmave mbështetës për konsumatorët në nevojë, si dhe ruajtjen e ekuilibrit ndërmjet interesave të konsumatoreve, shtetit dhe sipërmarrësve në këtë sektor.

Impakti

Për konsumatorin shqiptar çmimet e larta të energjisë në tregun global janë të ndjeshme dhe kanë impak ekonomik në tërësi për gjithë ekonominë shqiptare.

Rekomandimi

ERE të japë ndihmesën e saj në bashkëpunimin me palët si edhe asistencën e nevojshme për ato problematika që janë në kompetencat e saj për realizimin e këtij procesi.

Komentet e Drejtimit

ERE ka realizuar një studim për konsumin e energjise elektrike dhe sjelljen konsumatore në vendin tonë i cili i paraprin politikave të mundëshme për marrjen e masave mbështetëse. Ky studim është i publikuar në faqen eeb të ERE.

Në të njëjtën kohë ERE ka ngritur një Grupi punë për “Studimin e praktikave më të mira rregullatore për adresimin e mbështetjes për kategorinë e klientëve në nevojë dhe nxjerrja e skenarëve më të aplikueshëm” është ende në proces.

ERE më herët ka miratuar Rregulloren për kushtet e ndërperjes së furnizimit me energji elektrike të klientëve në nevojë, si një detyrim i ligjit të sektorit të energjisë për ERE, dhe i përmbushur në afat. Në kuptim të detyrimeve që i lindin të licencuarit FSHU sh.a nga kjo rregullore, kanë vijuar korrespondencat siç edhe më herët me FSHU sh.a për ti rikujtuar detyrat e lëna nga ERE mbi zbatimin e parashikimeve të këtij akti rregullator ku ndër te tjera veçojmë krijimin dhe ruajtjen e një rregjistri me numrin e klientëve në nevojë në formë të dhënash krahasimore e statistikore, si edhe procedurat e ndjekura për çrregjistrimin e këtyre klientëve përtej evidentimit të rasteve të ankimimit nga kjo kategori etj. Kjo detyrë e lënë në kalendarin e rezolutës është në proces.

Enti Rregullator i Energjisë (ERE) Letra për Drejtimin – Raporti Vjetor 2022

3. Metodologjia e çmimit të blerjes së energjisë elektrike të prodhuar nga vetëprodhuesit.

Çështje

Të vijojë intensivisht bashkëpunimin me Ministrinë e Infrastrukturas dhe Energjisë për hartimin sa më parë të metodologjisë së përcaktimit të çmimit të blerjes së energjisë elektrike të prodhuar nga vetëprodhuesit, si dhe të luajë një rol proaktiv dhe të bashkëpunojë me të gjithë aktoret për zgjidhjen e problematikave të ndryshme që lindin nga instalimi i burimeve të vogla të rinovueshme, si për shembull problemi i mënyrës së trajtimit të netimit nga ana e OSSH, etj.

Impakti

Meqënëse shqipëri ka potencial të lartë për investime nga vetëprodhueset kërkohet që ky treg të strukturohet në mënyrë efikente.

Rekomandimi

ERE të japë ndihmesën e saj në bashkëpunimin me palët si edhe asistencën e nevojshme për ato problematika që janë në kompetencat e saj për realizimin e këtij procesi.

Komentet e Drejtimit

Në përputhje me përcaktimet e ligjit të ri për Burimet e Rinovueshme, duke marrë në konsideratë praktikën më të mirë të vendeve të rajonit ERE do të plotësojë detyrimet që rrjedhin nga ky ligj. Kjo detyrë do të vijojë të jetë në proces.

*Enti Rregullator i Energjisë (ERE) Letra për Drejtimin – Raporti Vjetor 2022***4. Nxitja e vënies në funksion e bursës së energjisë elektrike.****Çështje**

ERE të kërkojë impenjim maksimal nga të gjithë aktoret për të bërë të mundur që brenda vitit 2022 operimi i bursës të jetë funksional.

Impakti

Funksionimi i bursës ka ndikim të drejtperdrejte në bashkimin e tregut të energjisë elektrike midis Shqipërisë dhe Kosovës, si dhe në lehtësimin e bashkimit me tregje të tjera të vendeve fqinje në përputhje me rregulloret e tregut të energjisë elektrike të BE-se dhe modelin e synuar evropian

Rekomandimi

ERE të japë ndihmesën e saj në bashkëpunimin me palët si edhe asistencën e nevojshme për ato problematika që janë në kompetencat e saj për realizimin e këtij procesi.

Komentet e Drejtimit

ERE ka vijuar punën për evidentimin dhe analizimin e kuadrit ligjor dhe nënligjor të Shqipërisë dhe Kosovës, që rregullon veprimtarinë e Bursës Shqiptare të Energjisë Elektrike – ALPEX sh.a. Gjithashtu është rritur komunikimi ndërinstucional me qëllim përmirësimin e kuadrit ligjor dhe harmonizimin e punës së Entit Rregullator të Energjisë dhe Zyrës së Rregullatorit për Energji ç'ka në dhjetor të vitit 2022 është finalizuar me nënshkrimin kolegjial të rregullave të operimit të bursës nga ERE dhe rregullatori i Kosovës. ERE gjatë vitit 2022 ka finalizuar procedurën e licencimit të "Bursës Shqiptare të energjisë elektrike – ALPEX" sh.a. në veprimtarinë e operimit të tregut të energjisë elektrike.

Në mbështetje të neneve 16; 18, pika 1, gërma "a" dhe "dh"; nenit 19 gërma "a", neneve 57 dhe 98 të ligjit nr. 43/2015, "Për sektorin e energjisë elektrike", i ndryshuar, Vendimit të Këshillit të Ministrave (VKM) nr. 519, datë 13.07.2016 "Për miratimin e modelit të tregut të energjisë elektrike" i ndryshuar si dhe të "Rregullores për organizimin, funksionimin dhe procedurat e ERE", miratuar me vendimin nr. 96, datë 17.06.2016, ERE në mbledhjen e perbashket me Rregullatorin e Kosoves në datën 27.12.2022, nepermjet vendimit nr. 347, datë 27.12.2022 miratoi rregullat t tregut të energjisë elektrike (rregullat e ALPEX përkufizimet, procedura e tregtimit si dhe procedura e kierimit dhe shlyerjes).

Në po këtë prizëm është duke punuar me asistencën e USAID për bashkërendimin e punës mes regullatoreve, TSO-ve dhe bursës për të mundësuar bashkimin e tregjeve midis Shqipërisë dhe Kosovës dhe më tej me Maqedoninë e Veriut apo dhe Malin e Zi.

*Enti Rregullator i Energjisë (ERE) Letra për Drejtimin – Raporti Vjetor 2022***5. Ndihmesë në ndërtimin e rrjetit të transmetimit dhe shpërndarjes së gazit natyror****Çështje**

ERE të vijojë mbështetjen me ekspertizën teknike për të bërë të mundur ndërtimin e rrjetit të transmetimit dhe shpërndarjes së gazit natyror si një projekt me rëndësi për vendin në drejtim të rritjes së prodhimit të energjisë dhe diversifikimit të burimeve të prodhimit, si dhe të bëjë propozime konkrete në funksion të mundësive të reja të krijuara për zhvillimin dhe shfrytëzimin e tregut të gazit. Fillimi nga puna i gazsjellësit TAP duhet parë me prioritet nga ERE si një mundësi që e bën akoma më të domosdoshëm ndërtimin e këtij rrjeti për rritjen e prodhimit të energjisë përmes shfrytëzimit të gazit.

Impakti

Ngritja e infrastrukturës së gazit është me rëndësi, pasi gazi jo vetëm sjell diversifikimin e burimeve në vend dhe është më ekonomik në përdorimin, por ka edhe emetim shumë herë më të vogël në ambient. Vonesat e mundshme në këtë proces kanë efekte negative për ekonominë shqiptare në disa këndvështrime.

Rekomandimi

ERE të japë ndihmesën e saj në bashkëpunimin me palët si edhe asistencën e nevojshme për ato problematika që janë në kompetencat e saj për realizimin e këtij procesi.

Komentet e Drejtimin

ERE ka paraprirë miratimit të disa akteve nënligjore të cilat kanë ndikuar si për mundësinë e ndërtimit të rrjetit të transmetimit dhe atë të Shpërndarjes.

Gjithashtu janë miratuar edhe aktet nënligjore mjaft të domosdoshme për Terminalin e LNG (Gazit Metan të Lëngëzuar) si dhe aktet e tjera për Ruajtjen nëntokësore të gazit natyror, në kripërat e zonës së Dumresë dhe konkretisht:

- Metodologjinë e llogaritjes së tarifës për LNG
- Rregulloren për terminalin e LNG
- Liçensën për të dhënë të drejtën e operimit të LNG
- Metodologjinë e llogaritjes së tarifës në hapsirat e depozitimit të gazit.
- Rregulloren për Ruajtjen nëntokësore të gazit
- Liçensën për ruajtjen nëntokësore të gazit në Dumre.

ERE po bashkëpunon me Entin Rregullator të Italisë dhe Greqisë për përmirësimin e akteve nënligjore të TAP siç janë: Kodi i rrjetit TAP, Market Testi për vitin 2022 që do të vazhdojë edhe për vitin 2023 e cila do të bëjë që të rritet kapaciteti transportues i gazit nga 10 miliard m³ gaz në një sasi më të madhe.

*Enti Rregullator i Energjisë (ERE) Letra për Drejtimin – Raporti Vjetor 2022***6. Përditësimi i faqes zyrtare në internet të linkut/grafika "Bëj një ankesë" në ERE****Çështje**

Në faqen zyrtare në internet duhet që linku/grafika "Bëj një ankesë" dhe numri i gjelbër në dispozicion të qytetareve/konsumatoreve të jetë në faqen kryesore dhe lehtësisht i aksesueshëm, mbrojtja e konsumatorit është një ndër objektivat kryesore të ERE-s.

Impakti

Mbrojtja e konsumatorit është një ndër objektivat kryesore të ERE-s. Ulja e impaktit të efekteve financiare të konsumatorit mbetet ndër objektivat kryesore të saj.

Rekomandimi

ERE të japë ndihmesën e saj në bashkëpunimin me palët si edhe asistencën e nevojshme për ato problematika që janë në kompetencat e saj për realizimin e këtij objekti.

Komentet e Drejtimit

- *Vënia në funksion e numrit të gjelbër për informimin e konsumatorit.*

ERE ka finalizuar procesin e nënshkrimit të kontratës me njërën nga kompanitë telefonike dhe aktualisht numri i gjelbër është aktiv. Ky numër shërben si një urë komunikimi pa kosto për konsumatorët me ERE-n.

- *Organizim trajnimi për grupe interesi me objekt "informimin mbi të drejtat e konsumatorit"*

Marreveshjet e Bashkëpunimit planifikohen të zhvillohen gjatë vitit 2023. Gjatë muajit prill 2022 nga ana e Qendrës së Konsumatorit Shqipëtar është organizuar seria e trajtimeve prezantuese në lidhje me rolin e institucioneve të ndryshme në mbrojtjen e konsumatorit si dhe të drejtat e detyrimeve të këtyre të fundit. Në takimin e realizuar në datë 07.05.2022, i cili lidhej kryesisht me të drejtat e konsumatorit përfaqësueset e ERE-s, prezantuan mes të tjerave si pjesë të fushatës informative, broshurat informative, si dhe mundësitë e aksesit në informacion të konsumatorëve.

- *Organizimi i tryezave të bashkëpunimit me zyrat e konsumatorit në bashkitë e vendit si dhe organizatat e krijuara për këtë qëllim.*

Nga ana e ERE-s, ka vijuar komunikimi me bashkitë kryesore në vend, si ajo e Tiranës dhe e Elbasanit. Është vendosur komunikimi me Bashkinë e Tiranës dhe do të zhvillohet brenda vitit 2023. Takimi me bashkinë e Elbasanit është organizuar me përfaqësues të këtij insitucioni si dhe përfaqësues të strukturave përkatëse për Zgjidhjen Alternative të Mosmarrëveshjeve pranë tyre. Në këto takime është prezantuar kuadri ligjor që rregullon sektorin e energjisë elektrike si dhe rolin e ERE në adresimin e problematikave të konsumatorit.

*Enti Rregullator i Energjisë (ERE) Letra për Drejtimin – Raporti Vjetor 2022***7. Vlerësimi nga ERE i Performancës së Shërbimit ndaj klientit****Çështje**

Gjatë vitit 2022 të miratojë dhe të fillojë zbatimin e rregullores për Masat e të Licencuarve në Aktivitetin e Furnizimit për Arritjen e Treguesve të Matjes dhe Vlerësimit nga ERE të Performancës së Shërbimit ndaj klientit.

Impakti

Miratimi i Rregullores mbi Masat e të Licencuarve në Aktivitetin e Furnizimit për arritjen e Treguesve të Matjes dhe Vlerësimit nga ERE do të sjellë përmirësimin e cilësisë së shërbimit ofruar konsumatorëve çka konsiston dhe në një nga detyrat kryesore të ERE.

Rekomandimi

Kjo detyrë e lënë në kalendarin e rezolutës rezulton e përmbushur.

Komentet e Drejtimin

Për këtë qëllim ERE me anë të vendimit nr. 23 datë 14.02.2022 miratoi Rregulloren mbi masat e të licencuarve në aktivitetin e furnizimit për arritjen e treguesve të matjes dhe vlerësimit nga ERE të performancës së shërbimit ndaj klientit. Ky vendim ka hyrë në fuqi më datë 01.06.2022 dhe efektet për qëllime të raportimit të parë përfshijnë periudhën 1 Qershor - 31 Dhjetor 2022.

Ne të njeten kohe ERE do të vijojë përpunimin e të dhenave sipas përcaktimeve të kësaj rregulloreje. Kjo detyrë e lënë në kalendarin e rezolutës rezulton e përmbushur.

*Enti Rregullator i Energjisë (ERE) Letra për Drejtimin – Raporti Vjetor 2022***8. Mbrojtja e të drejtave të konsumatoreve të energjise elektrike****Çështje**

ERE duhet të vijojë të ndjekë dhe monitorojë me rigorozitet problematikat që kanë lidhje me mbrojtjen e të drejtave të konsumatoreve të energjisë elektrike, në mënyrë të veçantë zbatimin e detyrave që rrjedhin për FSHU sh.a. në përputhje me vendimin e Bordit të ERE- "Mbi rishikimin e planit të masave për Operatorin e Shpërndarjes të Energjisë Elektrike "OSHEE sh.a.", për respektimin e të drejtave të klienteve të furnizimit me energji elektrike".

Impakti

Mbrojtja e të drejtave të konsumatorëve lidhet në mënyrë direkte me aspektet sociale dhe ekonomike të konsumatorëve, kështu që mbrojtja tyre kërkon monitorim të vazhdueshëm.

Rekomandimi

ERE të japë ndihmesën e saj në monitorim e problematikave për mbrojtjen e konsumatorit në marrëdhënie me palët si: FSHU sh.a.; OSSH sh.a.; OST sh.a etj. si dhe të japë asistencën e nevojshme për ato problematika që janë në kompetencat e saj.

Komentet e Drejtimit

Në lidhje me këtë detyrë rezulton se gjatë vitit 2022 janë parashikuar dhe kryer këto monitorime:

- Monitorim mbi sigurimin e aksesit të palëve të treta në përputhje me kërkesat e Ligjit dhe akteve të miratuara nga ERE. Afatet brenda të cilave OST sh.a. realizon lidhjen e re. Monitorim në FSHU sh.a. mbi afatet dhe procedurat e trajtimit të ankesave të konsumatorit.
- Monitorim në OSSH sh.a. lidhur me mbikqyrjen e standardeve të arritura të cilësisë së shërbimit të furnizimit dhe performancës së rrjetit të shpërndarjes së energjisë elektrike për periudhën janar 2021- mars 2022.
- Monitorim në OST sh.a. lidhur me mbikqyrjen e standardeve të arritura të cilësisë së furnizimit dhe performancës së sigurisë së rrjetit të transmetimit të energjisë elektrike për periudhën janar 2021- mars 2022.
- Monitorim në FSHU sh.a. lidhur me detyrimet dhe raportimet periodike si dhe mbi mbikqyrjen e zbatimit të detyrave që rrjedhin për të licencuarin nga vendimi i Bordit të ERE-s, nr.201/2018, i rishikuar me vendimin nr. 217/2020 mbi rishikimin e "Planit të masave për Operatorin e Shpërndarjes të Energjisë Elektrike OSHEE sh.a., për respektimin e të drejtave të klientëve të furnizimit me energji elektrike", të Miratuar me vendimin e bordit të ERE-s, Nr. 201, datë 03.09.2018.

Ne vijim ERE do të kërkoj informacion të detajuar mbi nivelin e zbatimit të rekomandimeve apo të gjetjeve të ERE sipas këtyre rekomandimeve.

*Enti Rregullator i Energjisë (ERE) Letra për Drejtimin – Raporti Vjetor 2022***9. Sensibilizimi i konsumatorit për përdorimin me eficiencë të energjisë elektrike****Çështje**

Ne bashkëpunim me Agjencinë e Eficencës dhe duke iu referuar edhe praktikave më të mira ndërkombëtare ERE të punojë për sensibilizimin e konsumatorit për përdorimin me eficiencë të energjisë elektrike.

Impakti

Ky sensibilizim për konsumatorin përkthehet në kursim të energjisë dhe në më pak kosto për vetë konsumatorin.

Rekomandimi

ERE të japë ndihmesën e saj në sensibilizimin e konsumatorit për përdorimin me eficiencë të energjisë elektrike.

Komentet e Drejtimit

ERE ka realizuar takime bilaterale me Agjencinë e Eficencës për diskutimin e praktikave të përbashkëta dhe ngritjen e një strategjie të përbashkët afatmesme për adresimin e çështjeve të interesit të konsumatorit sa i përket përdorimit eficient të energjisë.

Në të njëjtën kohë ERE ka vijuar korespondenca e takime mes përfaqësues Agjencisë së eficiencës, me qëllim mbarëvajtjen e fushatave të përbashkëta promovuese që lidhen me sensibilizimin e konsumatorit sa i përket përdorimit eficient të energjisë. ERE ka kërkuar nga FSHU sh.a. që në faturën e konsumit të energjisë elektrike, të përfshihet linku apo QR code i cili gjeneron broshurat informative të përgatitura në bashkëpunim mes ERE dhe agjencisë së eficiencës me qëllim njohjen e konsumatorit me masat që duhet të marrë për të kursyer energji.

*Enti Rregullator i Energjisë (ERE) Letra për Drejtimin – Raporti Vjetor 2022***10. Ofertimi i çmimeve nëpërmjet një platforme të furnizuesve të lincensuar.****Çështje**

ERE të marrë masat e nevojshme për realizimin dhe implementimin e platformes ërmes së cilës të licencuarit në veprimtarinë e furnizimit, që do ta ushtrojnë këtë aktivitet për furnizimin e klienteve në treg të lirë, do t'iu mundësohet të hedhin të dhënat në kohë reale në lidhje me çmimin e ofruar për furnizimin me energji elektrike në treg të lirë.

Impakti

Aksesimi i një platforme për të gjithë konsumatorët jep mundësinë e informimit në kohë reale të çmimeve në tregun e lirë, e cila bën të mundur transparencën dhe orientim e drejtë të konsumatorit në treg e lirë.

Rekomandimi

ERE të japë asistencën e nevojshme për realizimin e kësaj platforme të furnizuesve të lincensuar.

Komentet e Drejtimit

Në buxhetin e vitit 2022 është parashikuar fondi për blerjen e softit për realizimin dhe implementimin e platformës përmes së cilës të licencuarit në veprimtarinë e furnizimit që ushtrojnë aktivitetin e furnizimit të klientëve në treg të lirë, dhe është duke u implementuar kontrata për realizimin e kësaj platforme.

Platforma pritet të jetë në funksion brenda vitit 2023.

ERE do të vijojë të realizojë trajnime për furnizuesit me qëllim përdorimin e kësaj platforme. Si dhe do të rishikoj aktet rregullatore me qëllim implementimin e plotë të kësaj platforme.

Janë zhvilluar procedura e prokurimit me qëllim sigurimin e platformës përkatëse e cila do të jetë në funksion brenda vitit 2023.

*Enti Rregullator i Energjisë (ERE) Letra për Drejtimin – Raporti Vjetor 2022***11. Instalimi gradual i matësve inteligjentë, bazuar në një analize kosto-përfitim****Çështje**

Të vijojë të kërkojë mundësinë e instalimit gradual të matësve inteligjente, bazuar në një analizë kosto-përfitim dhe të mbulimit me rrjetin e telekomunikacionit, pasi veç të tjerash përmirëson cilësinë e shërbimit ndaj konsumatorit, duke evituar problematikat e mbifaturimit dhe ankesat e konsumatoreve. Faktet tregojnë se edhe gjatë vitit 2021 ankesat me objekt "Mbifaturim të energjisë elektrike" janë rritur krahasuar me një vit më parë duke zënë vend kryesor në totalin e ankesave të regjistruara në ERE.

Impakti

Përveç efekteve financiare të drejtpërdrejta ndaj konsumatorëve, mbifaturimi i energjisë elektrike ka efekte edhe për sektorin energjistik në tërësi, pasi do të rezultonte në deformim të treguesve ekonomik dhe financiarë të sektorit.

Rekomandimi

ERE të japë ndihmesën e saj në bashkëpunimin me palët si edhe asistencën e nevojshme për Instalimi gradual i matësve inteligjente, bazuar në një analize kosto-perfitim të cilat janë në kompetencat e saj.

Komentet e Drejtimit

ERE është duke vijuar komunikimi me OSSH sh.a, duke i kërkuar kësaj të fundit që të marrë masat për të kryer një analizë kosto përfitim për instalimin gradual të matësve inteligjentë në një numër më të madh konsumatorësh vecanërisht duke patur në konsideratë që instalimi i një sistemi të sigurt matjeje jo vetëm ul numrin e ankesave për mbifaturim dhe shmang problematika që lidhen me matjen, por edhe krijon mundësinë për konsumatorin qofte jo familjar por edhe atë familjar, që të shfrytëzojë hapësirë që ligji për sektorin e energjisë elektrike i ka garantuar, për të dale në treg të liberalizuar duke vlerësuar ofertat me të mira.

ERE do të vijojë të mbeshtesë realizimin e instalimit gradual të matësve inteligjentë nëpërmjet tarifave për operatorët e rrjetit.

Enti Rregullator i Energjisë (ERE) Letra për Drejtimin – Raporti Vjetor 2022

STATUSI I ÇËSHTJEVE SIPAS LETRËS SË DREJTIMIT TË VITIT 2021

1. Zvogëlimi i barrierave rregullatore

Çështje

Me qëllim zvogëlimin e barrierave rregullatore dhe shkurtimin e kohës së procedurave rregullatore, të kryeje një analize ex-post të rregulloreve përkatëse.

Impakti

Rishikimi dhe kryerja e një analize të rregulloreve aktuale, bën të mundur që të identifikohen mangësitë përkatëse, bazuar gjithashtu edhe në evidencat apo rastet specifike që mund të jenë raportuar, si pasojë e barrierave dhe burokracive rregullatorë. Dobësitë dhe problematikat e nxjerra nëpërmjet kësaj analize ex-post, shërbejnë për të përmirësuar kuadrin rregullator në vijim.

Rekomandimi

Realizuar me vendimin 220/2022.

Komentet e Drejtimit

Realizuar me vendimin 220/2022.

Enti Rregullator i Energjisë (ERE) Letra për Drejtimin – Raporti Vjetor 2022

STATUSI I ÇËSHTJEVE SIPAS LETRËS SË DREJTIMIT TË VITIT 2020

1. Pronësia e kabinave elektrike

Çështje

ERE për zgjidhjen e problematikës së pronësisë së kabinave elektrike të bëjë propozimet përkatëse edhe për ndryshime ligjore, nëse është e nevojshme, apo të japë rekomandimet e nevojshme për institucionet përkatëse dhe të kërkojë edhe ndërhyrjen e Kuvendit përmes Platformës Ndërinstitucionale Online, të ngritur nga Kuvendi i Shqipërisë, e cila është në dispozicion të institucioneve të pavarura si një mjet i ri që synon rritjen e autoritetit të institucioneve të pavarura, si dhe përfshirjen e Kuvendit të Shqipërisë si katalizator ndërmjet institucioneve të pavarura dhe atyre qeveritare për zgjidhjen e problemeve.

Impakti

Problematika me pronësinë e kabinave elektrike ndikon në krijimin e defekteve të shumta për abonentët duke ndikuar në cilësinë e shërbimit. Abonentët shpesh herë mbeten pa energji elektrike dhe ankohen drejtëpërdrejtë tek OSSH. Gjithashtu për OSSH humbjet në rrjet janë të mëdha për shkak të amortizimit të madh të kabinave dhe kushteve jo të mira të mbajtjes së tyre. Ato gjithashtu shfaqin edhe rrezik për jetën e individëve pranë tyre. Që ato të kalojnë në pronësi të tyre duhet bërë blerje të prokurimeve publike gjë që është e vështirë për tu realizuar.

Rekomandimi

Realizuar me ndryshimet e ligjit 43/2015 ne vitin 2020 neni 71/1.

Komentet e Drejtimit

Realizuar me ndryshimet e ligjit 43/2015 ne vitin 2020 neni 71/1.

*Enti Rregullator i Energjisë (ERE) Letra për Drejtimin – Raporti Vjetor 2022***2. Ankesat konsumatore për periudhën 2008-2011****Çështje**

Përgjatë viteve 2008-2011 ankesat e konsumatorëve kanë qënë të larta dhe kanë mbetur pa zgjidhje akoma edhe në ditët e sotme. Kryesisht përgjatë këtyre viteve konsumatorët janë ankuar ndaj CEZ shpërndarje, për mungesën e energjisë elektrike, mosdorëzim faturash, ose gabim faturimi por të dhëna të shumta ende mungojnë.

Impakti

Ekziston pasiguria lidhur me evidentimin e këtyre ankesave dhe pranimi i tyre si “dëm ekonomik” dhe “energji e pamatur”, ka vijuar me zgjidhje ende në ditët e sotme pasi nuk janë ende të mirëpërcaktuara. Ende mungon një zgjidhje konkrete nëse këta konsumatorë do të dëmshpërblehen apo do të jepet një zgjidhje e pëlqyeshme nga të dy palët. Problematikë qëndron fakti se në ato vite numri i kontratave me klientët në mënyrë të rregullt ka qënë i ulët dhe informaliteti më i lartë. Në ditët e sotme është e vështirë të vërtetohet nëse kanë qënë të rregullta apo jo për shkak të hendequt të madh të kohës.

Rekomandimi

Ne rekomandojmë që ERE në rolin e rregullatorit të japë një zgjidhje përfundimtare për zgjidhjen e ankesave në bashkëpunim me 3 shoqëritë duke bërë të mundur krijimin e një plani të përbashkët në mënyrë që numri i klientëve të ankuar të vijë duke u ulur. Përcaktimi i një standardi të përbashkët për zgjidhjen e ankesave të klientëve nëse do tu jepet zgjidhje apo do të mbyllet si çështje përfundimisht.

ERE të vijojë të ndjekë në bashkëpunim me strukturën përgjegjëse të shoqërisë FSHU sh.a. deri në zgjidhjen përfundimtare çështjen e ankesave të klientëve, të cilët janë faturuar nën emërtimet “energji e pamatur” dhe “dëm ekonomik” në periudhën tetor 2008 – prill 2011.

Komentet e Drejtimit

ERE ka vijuar me trajtimin e ankesave rast pas rasti dhe ka dhene rekomandimet perkatese per keto raste.ERE në rolin e rregullatorit ka vijuar më mbikëqyrjen e procesit të trajtimit të ankesave por ende nuk kemi një zgjidhje përfundimtare. Në këtë çështje ka ndikuar gjithashtu vendimi i Ministrisë së Shëndetësisë për izolimin e vendit me rastin e Covid-19. Gjithashtu është kërkuar një vlerësim për statusin apo numrin e kontratave me klientët përgjatë atyre viteve.

*Enti Rregullator i Energjisë (ERE) Letra për Drejtimin – Raporti Vjetor 2022***3. Sistemet informative dhe rreziku i sulmit kibernetik****Çështje**

Gjatë vitit 2020, me miratimin nga ERE të strategjisë për infrastrukturën kritike në ektorin e energjisë elektrike, ajo duhet t'i kushtojë vëmendje të veçantë implementimit të kësaj strategjie në përputhje me direktivën e BE-së “Për sigurinë e sistemit dhe sistemeve informatike”.

Impakti

Strategjitë e rregullores për sistemin informativ dhe mbrojtjen ndaj sulmeve kibernetike do të sillnin parandalimin e humbjeve të të dhënave në kushtet e një sulmi kibernetik. Vetëm OST deri më tani ka dërguar rregulloren e përcaktuar për informatizimin e tyre. Mungesa e një specialist IT të trajnuar mbi sigurinë e informacionit tek ERE do të sillte problematika në shqyrtimin e rregulloreve të sjella nga ana e shoqërive. Mungesa e raportimeve periodike nga ana e shoqërive tregon rrezikshmëri për rënien në kontakt të tyre me sulmet kibernetike sepse vëmendje kushtuar ndaj tyre mund të jetë më e vogël.

Rekomandimi

Ne rekomandojmë ERE të ndërmarrë masat e nevojshme dhe të vazhdueshme për të marrë rregulloret nga ana e 3 shoqërive KESH sh.a., OST sh.a, dhe OSHEE sh.a duke vendosur theksin tek sistemi i parandalimit të vjedhjes dhe humbjes së të dhënave.

Në të njëjtën kohë rezulton se ERE për efekte të Cyber security dhe platformave që ERE zotëron apo është në proces zhvillimi është e nevojshme ngritja e një infrastrukture IT në nivelin që të garantohet mbarvajtja e punës dhe siguria kibernetike dhe për institucionin. Duke marrë shkasë dhe nga sulmet kibernetike të viteve të fundit në vendin tonë.

Komentet e Drejtimit

Ere ka miratuar rregulloren për sigurinë kibernetike. Deri më tani ERE i është drejtuar 3 shoqërive KESH sh.a., OST sh.a, dhe OSHEE sh.a për masat e marra ndaj tyre në lidhje me implementimin e strategjisë së sistemeve informative sipas Direktivave të BE-së. Zhvillimi i takimeve të ndryshme me Autoritete të ndryshme për sigurinë kibernetike duke qënë se me anë të avancimeve teknologjike në çdo proces edhe ekspozimi ndaj rreziqeve është i madh.

ERE ne vijim do të merret me akomodimin e strukturës IT që përfshin paisjet hardëare dhe ambientet e nevojshme sipas kërkesave të akteve ligjore.

Enti Rregullator i Energjisë (ERE) Letra për Drejtimin – Raporti Vjetor 2022

REKOMANDIME TË TJERA

- Transpozimi dhe zbatimi i rregullores CACM (Alokimi i Kapaciteteve dhe Menaxhimi i Konxhestioneve) sipas vendimit të Keshillit të ministrave të vendeve antare të Komunitetit të Energjisë.
- Transpozimi i rregullores të FCA, (foreword capacity allocation)
- Berjen funksionale të sistemit rajonal të garancive të origjinës.

Lidhur me këto transpozime dhe miratime të akteve rregullatore që lindin si detyrime nga pjesmarrja në tregun vendas dhe rajonal të energjisë është e nevojshme që ERE të këtë konsulence të jashtme të specializuar në këto fusha.

*Enti Rregullator i Energjisë (ERE) Letra për Drejtimin – Raporti Vjetor 2022***Shtojcë****Përgjegjësia e Drejtimin për Objektivat dhe Kufizimet e Sistemit të Kontrollit të Brendshëm**

Komentet e mëposhtme u referohen përgjegjësise së Drejtimin për sistemin e brendshëm të kontrolleve, ku objektivat dhe kufizimet e qënësishme në sistemin e kontrollit të brendshëm janë marrë nga Standardet Ndërkombëtare të Auditimit të Federatës Ndërkombëtare të Kontabilistëve.

Përgjegjësia e Drejtimin

Drejtimi është përgjegjës për vendosjen dhe mirëmbajtjen e sistemit të kontrolleve të brendshme. Në përmbushjen e kësaj përgjegjësie, Drejtimi duhet të vlerësojë përfitimet dhe kostot e pritura përkatëse të politikave dhe procedurave për kontrollet e brendshme.

Objektivat

Objektivat e sistemit të kontrollit të brendshëm janë që të japin siguri drejtimi, sa më shumë të jetë e mundur, që asetet të jenë të mbrojtura nga përdorimi i paautorizuar ose keqpërdorimi, dhe se transaksionet janë ekzekutuar në përputhje me politikat e drejtimin dhe të regjistrohen saktë, në mënyrë që të mundësohet përgatitja në kohë e informacionit të besueshëm financiar në përputhje me parimet e zbatueshme të kontabilitetit.

Kufizimet

Për shkak të kufizimeve të qënësishme në çdo sistem të kontrollit të brendshëm, gabimet apo parregullsitë, mund të ndodhin dhe të mbeten të pazbuluara. Gjithashtu, parashikimi i çdo vlerësimit të sistemit të kontrollit të brendshëm për periudhat e ardhshme është subjekt i rrezikut që politikat dhe procedurat mund të bëhen të papërshtatshme për shkak të ndryshimeve të kushteve ose efektiviteti i hartimit dhe i zbatimit të politikave dhe procedurave mund të përkeqësohet.



Adresa: Rr. "L. Gurakuqi" Ndëtesa 18, H.4, K.6: Ap.21,
Tiranë, Albania
T: 04 56 28 875
Web: www.viar.al



Str. Margarita Tutulani,
Palazzo Viridario 1, 1-st floor,
Tirana, Albania
T: +355 4 223 2726
www.nexia.al

RAPORT DHËNIE SIGURIE - RAPORTI VJETOR 2022

Enti Rregullator i Energjisë (ERE)

Tiranë, më 30 Mars 2023



Adresa: Rr. "L.Gurakuqit" Ndëtesa.18; H.4; K.6; Ap.21,
Tiranë, Albania
T: 04 56 28 875
Web: www.viar.al



Str. Margarita Tutulani,
Palazzo Vindario 1, 1-st floor,
Tirana, Albania
T: +355 4 223 2726
www.nexia.al

RAPORT I SIGURISË SË PROFESIONISTIT TË PAVARUR

Drejtuar: Kryetarit dhe Bordit të Entit Rregullator të Energjisë (ERE)

Enti Rregullator i Energjisë ("ERE" ose "Enti") angazhoi audituesit e pavarur Shoqërinë "VIAR-Consulting" shpk me Audituese Ligjore Znj. Fatime Alliu me Licensë Nr.166 dhe Shoqërinë Nexia AL shpk, me Audituese Ligjore Znj. Orjana Kalaja me Licensë Nr.284 (referuar më tej si "Audituesit"), për të shqyrtuar informacionin jo-financiar të paraqitur në Raportin Vjetor për vitin e mbyllur më 31 Dhjetor 2022 ("të dhëna të zgjedhura"), me qëllim dhënien e sigurisë së kufizuar sipas kritereve të përshkruara më poshtë (Qëllimi i punës). Për qëllimet e këtij raporti, të dhënat e zgjedhura kanë të bëjnë me veprimtarinë e Entit në Shqipëri dhe nuk përfshijnë informacione që kanë të bëjnë me palë të tjera bashkëpunuese ose aktivitete / performanca të palëve të treta.

Qëllimi i punës

Angazhimi i dhënies së sigurisë është planifikuar dhe kryer në përputhje me Standardin Ndërkombëtar SNAS 3000, "Angazhimet e Dhënies së Sigurisë ("SNAS 3000") që ndryshojnë nga Auditimet ose Rishikimet e Informacioneve Financiare Historike", me qëllim që të japim një opinion për dhënie sigurie të nivelit të kufizuar për:

- Verifikimin e informacioneve shpjeguese cilësore dhe sasiore të paraqitura në Raportin Vjetor 2022 në mënyrë specifike për gjendjen në sektorin e energjisë elektrike dhe të gazit natyror, në krahasim me kriteret e zbatueshme ("Kriteret e Përformances", të ilustruara në Raportin Vjetor), mbështetur në Ligjin nr. 43/2015, "Për Sektorin e Energjisë Elektrike", i ndryshuar dhe Ligjin Nr. 102/2015 "Për Sektorin e Gazit Natyror", i ndryshuar.



Adresa: Rr. "L.Gurakuqi/Ndëtesa.18; H.4; K.6; Ap.21,
Tiranë, Albania
T: 04 56 28 875
Web: www.viar.al



Str. Margarita Tutulani,
Palazzo Vridano 1, 1-st floor,
Tirana, Albania
T: +355 4 223 2726
www.nexia.al

Përgjegjësitë e drejtimit

Drejtimi i të Entit Rregullator të Energjisë është përgjegjës për përgatitjen, prezantimin, tërësinë dhe saktësinë e të dhënave jofinanciare të dhëna për ne, siç paraqiten në Raportin Vjetor 2022. Për më tepër, drejtimi i ERE është përgjegjës për regjistrimet e mbajtura dhe kontrollet e brendshme të përshtatshme që janë krijuar për të mbështetur procesin e raportimit dhe të përputhshmerisë ligjore. Në mënyrë të veçantë, drejtimi është përgjegjës për hartimin e kontrolleve të brendshme dhe zbatimin e tyre për të parandaluar që Raporti të këtë anomali materiale.

Përgjegjësitë e Audituesve

Ne kemi kryer një shërbim dhënie sigurie të kufizuar. Përgjegjësia jonë është të shprehim konkluzionin tonë bazuar në procedurat e kryera, për të dhënat e zgjedhura, siç përshkruhet më sipër në seksionin "Qëllimi i punës".

Përgjegjësia jonë është e kufizuar në informacionin shpjegues për vitin e mbyllur më 31 dhjetor 2022, të prezantuara në Raportin Vjetor për vitin 2022.

Në masën që lejohet nga legjislacioni në fuqi, ne nuk pranojmë dhe nuk marrim asnjë përgjegjësi për angazhimin tonë, ndaj kujt do tjetër përveç ERE, përveç rasteve kur është rënë dakord në mënyrë të shkruar, me pëlqimin tonë paraprak.

Ne kemi kryer punën tonë duke mbledhur gjithë të dhënat, dokumentacionin përkatës, informacionin dhe shpjegimet që ne i konsideruam të nevojshme për të dhënat e zgjedhura të përshkruara, në seksionin "Qëllimi i punës". Procedurat e ndjekura në lidhje me të dhënat e zgjedhura përfshijnë:

- Intervistat me drejtimin dhe personelin përgjegjës për informacionin dhe supozimet përkatëse.
- Vizita në ambientet e Entit Rregullator të Energjisë.



Adresa: Rr. "L.Gurakuqi; Ndëtesa.18; H.4; K.6; Ap.21,
Tiranë, Albania
T: 04 56 28 875
Web: www.viar.al



Str. Margarita Tutulani,
Palazzo Viridario 1, 1-st floor,
Tirana, Albania
T: +355 4 223 2726
www.nexia.al

- Rishikimit dhe vlerësimit të proceseve dhe kontrolleve të përdorura për mbledhjen, grumbullimin, vlerësimin dhe raportimin e të dhënave;
- Teste me zgjedhje mbi të dhënat e mbledhura dhe formulat, kur kërkohen.

Niveli i Dhënies së Sigurisë

Procedurat që kemi kryer janë hartuar për të ofruar siguri të kufizuar, sic specifikohet në SNAS 3000, mbi të cilat ne u bazuam për të arritur në konkluzione për angazhimin tonë. Këto procedura nuk janë aq të zgjeruara sa ato që kërkohen për dhënien e sigurisë së arsyeshme, për pasojë, merret një nivel më i ulët i sigurisë.

Kufizimet

Për të kryer punën tonë, ne u mbështetëm ekskluzivisht në informacionin e dhënë nga drejtuesit e Drejtorive të Entit Rregullator të Energjisë, të cilin ne e pranuan me mirëbesim si informacion të plotë, të saktë, të vërtetë dhe jo mashtrues.

- Si rrjedhim, ne nuk kemi kryer procedura verifikimi shtesë, përveç procedurave të përcaktuara në mënyrë të qartë në Raportin tonë në seksionin, Përgjegjësitë e Audituesve, të cilat rrjedhin nga metodologjia e rënë dakort reciprokisht.
- Asnjë punë nuk është kryer për të dhënat të periudhave të raportimeve të mëparshme, si dhe mbi të dhënat në lidhje me objektivat dhe parashikimet.
- Asnje punë nuk është kryer për asgjë tjetër përveç qëllimit të rënë dakord dhe për rrjedhojë, konkluzioni ynë është i kufizuar për këtë qëllim.

Pavarësia

Audituesit zbatojnë kërkesat e Standardit Ndërkombëtar për Kontrollin e Cilësisë nr.1. Bazuar në këtë, mbajmë një sistem të kontrollit të integruar të cilësisë që përfshin politikat dhe procedurat për respektimin e parimeve morale, standardeve profesionale dhe kërkesave përkatëse ligjore dhe rregullatore. Ne jemi në përputhje me kërkesat e pavarësisë dhe

3



Adresa: Rr. "L.Gurakuqi", Ndëtesa. T8; H.4; K.6; Ap.21,
Tiranë, Albania
T: 04 56 28 875
Web: www.viar.al



Str. Margarita Tutulani,
Palazzo Vindario 1, 1-st floor,
Tirana, Albania
T: +355 4 223 2726
www.nexia.al

standardet e tjera etike të Kodit Etikes së IFAC për profesionistët të Bordit të Standardeve Ndërkombetare të Etikes për Audituesit (IESBA), i cili bazohet në parimet themelore të integritetit, paanshmerisë, përshtatshmerisë profesionale, konfidencialitetit dhe sjelljes profesionale. Në këtë kontekst, ekipi Audituesve për dhënien e sigurisë është i pavarur nga Enti Rregullator të Energjise dhe nuk ka marrë pjesë në përgatitjen e Raportit Vjetor për vitin 2022.

Konkluzione

Bazuar në procedurat e kryera dhe evidencën e marrë, asgjë nuk na ka tërhequr vëmendjen tonë që të na bëjë të besojmë se ka ndonjë gabim ose anomali që do të ndikonte materialisht në dhënien e informacioneve rreth përputhshërisë ligjore të aktivitetit (përfshirë shënimet shpjeguese dhe referencat përkatëse) sic paraqiten në Raportin Vjetor të Entit Rregullator të Energjisë për vitin e mbyllur më 31 Dhjetor 2022. Për më tepër, asgjë nuk ka tërhequr vëmendjen tonë që të bëjë të besojmë se të dhënat e paraqitura, nuk janë përgatitur, në të gjitha aspektet materiale, në përputhje me kriteret e përmendura më lart, në seksionin "Qëllimi i punës".

Nexia-AL sh.p.k

Orjana Kalaja

Auditues Ligjor
License Nr.284



VIAR-Consulting sh.p.k

Fatime Alliu

Auditues Ligjor
License Nr.166

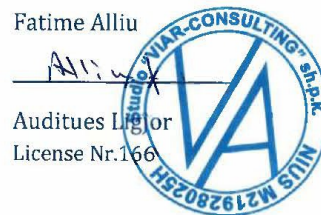

Tiranë, 30/03/2023